



UNIVERSITY OF NOVI SAD  
TECHNICAL FACULTY „MIHAJLO PUPIN“  
ZRENJANIN, REPUBLIC OF SERBIA



9th international scientific – professional conference  
**"TEXTILE SCIENCE & ECONOMY 2018"**

**PROCEEDING**  
November 6<sup>th</sup> Zrenjanin

**Organiser of the Conference:**

University of Novi Sad, Technical Faculty „Mihajlo Pupin“, Zrenjanin, Republic of Serbia

**Publisher:**

University of Novi Sad, Technical Faculty „Mihajlo Pupin“, Zrenjanin, Djure Djakovica bb, 23000 Zrenjanin, Republic of Serbia.

**For publisher:**

Dragica Radosav, Ph. D, Proffessor, Dean of the Technical faculty „Mihajlo Pupin“.

**Cheaf editor:**

Vasilije Petrovic, Ph.D, Proffessor, Head of Department for textile and clothing science and design at Technical faculty "Mihajlo Pupin".

**The Committee for editing:**

Ph.D Vasilije Petrovic, Technical Faculty „Mihajlo Pupin“, Zrenjanin, Serbia,  
Ph.D Jovan Stepanovic, Faculty of Technology, Leskovac, Serbia,  
Ph.D Goran Demboski, Faculty of Technology and Metallurgy, Skopje, Macedonia,  
Ph.D Dusan Trajkovic, Faculty of Technology, Leskovac, Serbia

**Secretaries:**

Danka Joksimovic, M.Sc, Assistant  
Stanislava Sindjelic, M.Sc, Assistant

**Technical treatment and design:**

Vasilije Petrovic, Ph. D, Proffessor  
Danka Joksimovic, M.Sc, Assistant  
Anita Milosavljevic, M Sc, Faculty of Technology, Leskovac, Serbia  
Stanislava Sindjelic, M.Sc, Assistant

ISBN: 978-86-7672-314-0

CIP - Cataloging in a publication  
Biblioteka Matice srpske, Novi Sad

677 (082)

INTERNATIONAL SCIENTIFIC-TECHNICAL CONFERENCE Textile Science and Economy (9, 2018, Zrenjanin)  
Proceedings [Electronic Source] / 9th International Scientific-Professional Conference Textile Sciences and Economy 2018, November 6, Zrenjanin; [editor of the publisher Vasilije Petrovic]. - Zrenjanin: Technical Faculty "Mihajlo Pupin", 2018 - 1 electronic optical disc (CD-ROM); 12 cm

Title from the title screen. - Str. 5-6: Introduction / Vasilije Petrovic. - Bibliography with every work.

ISBN 978-86-7672-314-0

a) Textile industry - Chambers  
COBISS.SR-ID 326460935

**Note:**

All the papers presented in this publication have been reviewed. However the editor's and organizer are not responsible for the contents presented within paper.

---

## **THE SCIENTIFIC AND REVIEWING COMMITTEE:**

**President of Committee: Ph.D Jovan Stepanovic**, Faculty of Technology, Leskovac, Serbia,  
**Ph.D Xu Ming**, Dong Hua University, Shanghai, China,  
**Ph.D Wang Hua**, Dong Hua University, Shanghai, China,  
**Ph.D Nikola Zivlak**, Emlyon business school Asia,  
**Ph.D Florea Hariton**, Universitatea de Vest din Timisoara – Facultatea de Arte, Romania,  
**Ph.D Riemschneider Eugenia Elena**, Universitatea de Vest din Timisoara – Facultatea de Arte, Romania,  
**Ph.D Laszlo Koltai**, Obuda University, Budapest, Hungary,  
**Ph.D Kisfaludy Marta**, Obuda University, Budapest, Hungary,  
**Prof. Dr. Roshan Paul**, University of Beira Interior, Portugal  
**Ph.D Darko Ujevic**, Faculty of Textile Technology, Zagreb, Croatia,  
**Ph.D Budimir Mijovic**, Faculty of Textile Technology, Zagreb, Croatia,  
**Ph.D Jelka Gersak**, University of Maribor, Slovenia,  
**Ph.D Goran Demboski**, Faculty of Technology and Metallurgy, Skopje, Macedonia,  
**Ph.D Sonja Kjartoseva**, Faculty of Technology and Metallurgy, Skopje, Macedonia,  
**Ph.D. Igor Jordanov**, Faculty of Technology and Metallurgy, Skopje, Macedonia,  
**Ph.D Samir Pacavar**, University of Travnik, Travnik, Bosnia and Herzegovina,  
**Ph.D Milan Gasovic**, University Singidunum, FFKMS, Serbia,  
**Ph.D Dusan Trajkovic**, Faculty of Technology, Leskovac, Serbia,  
**Ph.D Nenad Cirkovic**, Faculty of Technology, Leskovac, Serbia,  
**Ph.D. Dragica Radosav**, Technical Faculty „Mihajlo Pupin“, Zrenjanin, Serbia,  
**Ph. D Dusko Letic**, Technical Faculty „Mihajlo Pupin“, Zrenjanin ,  
**Ph.D Vasilije Petrovic**, Technical Faculty „Mihajlo Pupin“, Zrenjanin, Serbia,  
**Ph.D Visnja Mihajilovic**, Technical Faculty „Mihajlo Pupin“, Zrenjanin,  
**M.Sc Srdjan Cakic**, Faculty of Technology, Leskovac, Serbia,  
**M.Sc Danka Joksimovic**, assistant, Technical Faculty „Mihajlo Pupin“, Zrenjanin,  
**M.Sc Stanislava Sindjelic**, asstant, Technical Faculty „Mihajlo Pupin“, Zrenjanin,  
**M.Sc Marija Pesic**, assistant, Technical Faculty „Mihajlo Pupin“, Zrenjanin.  
**M.Sc Anita Milosavljevic**, Faculty of Technology, Leskovac, Serbia

---

## **ORGANIZING COMMITTEE:**

**Ph. D Vasilije Petrović**, Technical Faculty „Mihajlo Pupin“, Zrenjanin, President of Committee,  
**Ph. D Dragica Radosav**, Technical Faculty „Mihajlo Pupin“, Zrenjanin ,  
**Ph. D Dusko Letic**, Technical Faculty „Mihajlo Pupin“, Zrenjanin ,  
**Milorad Vasiljevic**, secretary for textiles in Chamber of commerce of Serbia,  
**Dragomir Djukic**, Chamber of commerce of Vojvodina,  
**Novica Abadzic**, Chamber of commerce of Vojvodina,  
**M Sc Snezana Milosevic**, S.M.Style, Beograd,  
**Marko Marinkovic**, Sitotehnika d.o.o., Beograd,  
**Golub Radivojevic**, Mona d.o.o., Beograd,  
**Ivan Radovanovic**, Miteks d.o.o., Arilje,  
**Bogomir Bojic**, Mondeks d.o.o., Novo Milosevo,  
**Nikola Kaljevic**, InTrikotaza d.o.o., Arilje,  
**Nenad Jovic**, Victory Style, Novi Sad – Rumenka,  
**Mladen Jovic**, Victory Style, Novi Sad – Rumenka,  
**Anel Adrovic**, La Vista d.o.o., Berane  
**Ph.D Nadežda Ljubojev**, Technical Faculty „Mihajlo Pupin“, Zrenjanin,  
**Ph.D Visnja Mihajilovic**, Technical Faculty „Mihajlo Pupin“, Zrenjanin,  
**M.Sc Danka Joksimovic**, assistant, Technical Faculty „Mihajlo Pupin“, Zrenjanin,  
**M.Sc Stanislava Sindjelic**, asstant, Technical Faculty „Mihajlo Pupin“, Zrenjanin,  
**M.Sc Marija Pesic**, assistant, Technical Faculty „Mihajlo Pupin“, Zrenjanin,  
**M.Sc Anita Milosavljevic**, student, Faculty of Technology, Leskovac,  
**Jelena Djukic**, student, Technical Faculty „Mihajlo Pupin“, Zrenjanin,  
**Ivana Lukic**, student, Technical Faculty „Mihajlo Pupin“, Zrenjanin,  
**Ivana Jelic**, student, Technical Faculty „Mihajlo Pupin“, Zrenjanin,  
**Milica Stojanovic**, student, Technical Faculty „Mihajlo Pupin“, Zrenjanin,  
**Maja Kostic**, student, Technical Faculty „Mihajlo Pupin“, Zrenjanin,  
**Aleksandra Savić**, student, Technical Faculty „Mihajlo Pupin“, Zrenjanin,

## **INTRODUCTION**

Department of Textile Science and clothing design of the Technical Faculty "Mihajlo Pupin", University of Novi Sad, organizes in cooperation with the Faculty of Engineering, Pamukkale University in Denizli, Turkey, the international conference "Textile Science and Economy IX" – TNP 2018.

These two high education institutions plan to work together to improve their project of international conference "Textile Science and Economy" that has been successfully developing for the past eight years. Many participants of this project indicated that the economic entities of the textile sector cannot develop successfully without textile science. This is confirmed by a large number of textile companies dominant in the market, that its dominance is based on constantly placing new and market-friendly products. However, the application of scientific research, through the development and commercialization of new products is a very complex process, which, often by corporate entities, especially those of them in less developed countries, is not appreciated and understood appropriately. Therefore, the international conference "Textile Science and Economy" is increasingly becoming a place of presenting examples of good practice in linking textile science and economy.

Many so far presented papers at the conference indicate that the connectivity of textile science and economy as well as for the successful development of companies is a key factor. Therefore this conference is increasing the focus of its work towards the goal of finding the best ways to attract and educate in this sector a large number of highly creative staff. Many studies show that only a highly creative staff can provide solutions to develop new technologies and products capable to cope with the strong competition on the world market.

International Conference "Textile Science and Economy" with its work so far has significantly contributed to improving the work of the Technical Faculty "Mihajlo Pupin". Using the knowledge and contacts made at this conference it has established cooperation with a number of universities and companies. It should be emphasized that with the Conference it was possible to establish a Cooperation Agreement with the greatest university in the world in this field, Donghua University in Shanghai. This Agreement in addition to the joint cooperation projects, enables the exchange of students. Last year two of our students had been participants of the Summer School of Design, organized by the University. Also the cooperation with the Faculty of Mechanical Engineering, University of Maribor, has enabled in the last few years, the participation of our students in the School of Design, which they organize. From business entities we need to mention excellent cooperation with the French company Lectra and the German company Pirin Tex. The contract with the French company Lectra has enabled the opening of the education center for training students in software and equipment of the world's largest company in the field of software and equipment for the fashion industry and soft materials. The contract with the German company Pirin Tex provides professional training of students in the company, which has 3.500 employees. Also it is worth mentioning that we have contracts with our companies and an established cooperation concerning vocational training and employment of our students through the project Fair for practices (internships).

This year the project international conference "Textile Science and Economy" continues with activities related to establishing stronger ties with industry. Specifically, the Conference will partly take place in Arilje - the region with more than 300 small and medium-sized textile enterprises. Students will offer these companies a conceptual design of new products which they will show at fashion shows and exhibitions that will be organized in the framework of the Conference.

For the first time at the conference their works through fashion show will show and students Faculty of Art and Design - West University of Timisoara. This is the result of partnership and cooperation between our two universities, in the framework of the international project, funded by the European Union through the CBC Romania - Serbia: "The analysis of innovation and cooperation ability and development opportunities of SMEs in the Serbian-Romanian cross border area inspired by the cultural heritage of the Serbian and Romanian people - BANAT FASHION "MIS-1427th

President of the Organizing Committee:



---

Prof. dr Vasilije Petrovic

## FLAGS OF PARTICIPATING COUNTRIES



**Serbia**



**Turkey**



**China**



**Croatia**



**Romania**



**Macedonia**



**Hungary**



**Czech Republic**



**Bosnia and Herzegovina**



**Portugal**



**Bulgaria**



**Slovenia**



**Italy**



**Germany**



**Sweden**

## **WORD OF THANKS**

### **Thanks for the partnership:**

- **Faculty of Engineering, Pamukkale University, Denizli, Turkey.**
- **Faculty of Arts and Design, West University of Timisoara, Romania**
- **Ministry of Education, Science and Technological Development - for support the conference TNP 2018**





---

**CONTENTS**

---

## CONTENT

<b>Volkan Kaplan</b> FOTOVOLTAIK FABRICATION _____	14
<b>Mátra Kisfaludy, Éva Hottó</b> PROJECTS IN EDUCATION – UNIFORM DESING _____	21
<b>Moga Ioana Corina (*), Dontu Octavian, Pricop Floarea, Iordache Ovidiu, Petrescu Gabriel</b> BIOLOGICAL WASTEWATER TREATMENT USING INNOVATIVE EQUIPMENT AND MATERIALS _____	27
<b>Nikola Zivlak, J. Djukic, D. Joksimovic, A. Milosavljevic, J. Stepanovic</b> BUYERS APPROACH WHEN SELECTING A FASHION PRODUCT _____	33
<b>Darko Ujević, Blaženka Brlobašić Šajatović, Bin Yu, Yunchu Yang</b> BODY PROPORTIONS OF SPORTS FOOTBALL POPULATION AND THEIR IMPACT ON GARMENT CONSTRUCTION _____	40
<b>Maja Jankoska, Goran Demboski</b> HAND AND SEWABILITY OF WOVEN FABRICS FOR TAILORED GARMENT _____	48
<b>Nenad Stojanovic, M. Pavlovic, D. Joksimovic, A. Milosavljevic, V. Petrovic</b> TEAMWORKING ON A FASHION COLLECTION INSPIRED BY THE SERBIAN CULTURE IN HUNGARY _____	55
<b>Éva HOTTÓ, Gabriella OROSZLÁNY</b> UNIFORMS - WORKWEAR – ERGONOMY _____	68
<b>Mirjana Ristic, J. Skenderović, A. Milosavljevic, D. Joksimovic, M. Pesic</b> FASHION COLLECTION INSPIRED BY TRADITIONAL “BUNJEVAC” ATTIRE _____	75
<b>Irma Radovan, Ksenija Doležal*, Renata Hrženjak</b> INFLUENCE OF FASHION TRENDS ON DEVELOPMENT OF UNDERWEAR _____	82
<b>Slavisa Djurdjevic, Nevena Igić, V. Petrovic, A. Milosavljevic, D. Joksimovic</b> TEXTILE MATERIALS IN MEDICINE _____	88
<b>Pricop Floarea, Popescu Alina, Chirila Laura, Rascov Marian, Scarlat Razvan, Cerempei Angela, Muresan Emil, Moga Corina</b> RESEARCH REGARDING THE DEVELOPMENT OF FUNCTIONALIZED TEXTILES BY USING PLANT EXTRACTS WITH BIOACTIVE PROPERTIES _____	97
<b>M. Novak, J. Djukic, D. Joksimovic, A. Milosavljevic, M. Pesic</b> PROTECTIVE CLOTHING _____	104

<b>Darko Ujević, Blaženka Brlobašić Šajatović, Ksenija Doležal</b> IMPACT OF BODY PROPORTIONS AND GARMENT SIZING SYSTEM ON THE MANUFACTURE OF FASHION WEAR _____	114
<b>Boryana Vatova, M. Pavlovic, A. Milosavljevic ,D. Joksimovic, V. Petrovic</b> ANALYSIS OF THE TECHNOLOGICAL PROCESS OF THE PRODUCTION OF WOMEN'S UPPER CLOTHES ON THE EXAMPLE OF GERMAN COMPANY "PIRIN - TEX" _____	123
<b>Vojislav Gligorijevic, Goran Demboski, Radica Nacic, Jovan Stepanovic, Nenad Cirkovic</b> GEOMETRICAL MODELLING OF PLAIN WEFT KNITTED FABRICS _____	131
<b>Mihalj Bakator, Dragan Čočkalo, Miloš Vorkapić</b> LEAN MANUFACTURING PRINCIPLES FOR IMPROVING PRODUCTIVITY IN THE TEXTILE INDUSTRY _____	139
<b>Marija Pešić, Vasilije Petrović, Danka Joksimović, Anita Milosavljević</b> A RESEARCH OF COMFORT PROPERTIES OF 1x1 RIB KNITTED FABRIC _____	146
<b>Anita Milosavljević, V. Petrović, D. Joksimović, S. Sindelić, N. Petrović</b> PROPERTIES OF GEOTEXTICAL MATERIAL AND THEIR APPLICATION _____	152
<b>Tatjana Šarac, Nenad Čirković, Sandra Stojanović, Nataša Radmanovac</b> AIR PERMEABILITY AS CHARACTERISTIC OF KNITWEAR INTENDED FOR ACIVE WEAR _____	164
<b>D. Joksimovic, V. Petrovic, A. Milosavljevic, S. Sindjelic, N. Petrovic</b> TESTING METHODS OF RESISTANCE FOR MASE CRYMPLE OF KNITTED AND LAMINATED MATERIALS FOR CAR UPHOLSTERY _____	170
<b>Jovana Stepanovic, Dusan Trajkovic, Nataša Radmanovac, Jovan Stepanovic</b> ANALYSIS OF TEXTURED PES FILAMENT YARN CHARACTERISTICS IN THE ZONE OF ELASTIC DEFORMATIONS _____	176
<b>Nadežda Ljubojev, Mila Kavalić*, Sanja Stanisavljev</b> AUTHORSHIP AS A SUBJECT OF COPYRIGHT _____	182
<b>Stanislava Sindelić, Srđan Cakić, Vasilije Petrović, Danka Joksimović, Anita Milivojević</b> SCARVES AS AN ELEMENT OF CLOTHING IN THE TWENTIETH CENTURY _____	189
<b>Sanja Jovic, Vasilije Petrovic, Danka Joksimovic, Anita Milosavljevic</b> MEASUREMENT OF LOSS OF THERMAL GLAY HEATING PERIOD FROM THE TYPE OF MATERIAL _____	196
<b>Marjanović Milica, P. Vasilije, M. Anita, J. Danka, S. Stanislava</b> THE PROCESS OF EDUCATION OF EMPLOYEES IN CLOTHING INDUSTRY BASED ON EXAMPLE OF GERMAN COMPANY PIRIN-TEX _____	200

---

<b>Anita Milosavljević, V. Petrović, D. Joksimović, S. Sindelić</b> THE USE OF THREE-DIMENSIONAL KNITTED MATERIALS _____	208
<b>M. Kostic, V. Petrovic, A. Milosavljevic, D. Joksimovic</b> OPTIMIZATION OF THE PRODUCTION OF CHILDREN’S CLOTHING ON THE EXAMPLE OF “FORMA VS” _____	218
<b>D. Joksimovic, V. Petrovic, A. Milosavljevic, S. Sindjelic</b> TESTING OF STRENGTH OF SEAMS ON UNIFORMS _____	227
<b>Milica Marjanović, V. Petrović, Nikola Zivlak, D. Joksimović, A. Milosavljević, S. Sindelić,</b> THE EXPERIENCE OF SUMMER SCHOOL AT DONGHUA UNIVERSITY IN SHANGHAI _____	232
<b>Anita Milosavljević, D. Trajković, N. Ćirković, J. Stepanović</b> ANALYSIS OF INTERFACE CHARACTERISTICS OF SIDE SEAM ON THE CLOTHING _____	238
<b>D. Joksimovic, V. Petrovic, A. Milosavljevic, S. Sindjelic</b> TECHNOLOGY FOR THE MANUFACTURE OF CAP (TULJAK) _____	245
<b>Teodora Šešum, V. Petrović, A. Milosavljević, D. Joksimović, J. Stepanović</b> APPLICATION OF TEXTILE MATERIALS IN PLANE INDUSTRY _____	253
<b>Anita Milosavljević, V. Petrović, D. Joksimović, S. Sindelić</b> TESTING OF STRENGTH OF COTTON FABRICS OF DIFFERENT DENSITIES BY WEFT IN INTERTWINE OF LINEN _____	260
<b>Valentina Bozoki</b> IMPACT OF PRODUCT QUALITY AND MARKETING ON THE SALES OF FASHION PRODUCTS _____	269



## FOTOVOLTAIK FABRICATION

**Volkan Kaplan**

Pamukkale University, Department of Textile Engineering, Denizli, Turkey

### ABSTRACT

*Energy and environment are so important topics with World wide espacially for several decates. Increasing population and enegy consumption forced us improving solar enery sources. Solar power plants consist of photovoltaic materials which these can be generated if sunlight falls on them. The advantages of photovoltaics such as being cheap, easy to produce, bending facilities and wide application, provide great advantages among all kinds of solar cells. As is known, the widespread use of solar cells in cities due to their costs and installation difficulties is still out of the question and does not seem to be in the future. Fabrics produced with photovoltaic materials can be considered as solar power plants. They must urgently develop the technologies of southern Europe and the Asia Asia.*

**KeyWords:** *Fotovoltaik, Solar Enegy, Fotovoltaik Fabrication, electisy generation.*

### INTRUDUCTION

However, due to the relatively high costs of solar panels produced by today's technology and the static structure of the existing buildings in our country, it is not possible to use normal solar panels widely. For this reason, the extent of the widespread effect that the fabrics to be produced with photovoltaic materials, which can be found in closing the energy deficit in the whole of southern Europe, especially our country, promises great potential.

According to data from the International Energy Agency, photovoltaic energy currently accounts for 0.5% of the global energy consumption. However, due to the developments in photovoltaic technology, it is estimated that this ratio will increase by 7% in 2030, 25% in 2050 and 33% in 2060 due to the decrease in costs. These expectations reveal the importance of investments in solar energy.

Photovoltaic materials generating electricity when exposed to light (PV), semiconductors (PN) and insulating materials are combined to form a photovoltaic panel. Photovoltaic technology began with crystalline silicon based materials. 24.7% electric genereting yield in laboratory environment with single crystalline silicones, Then low-cost silicone-based thin films have been developed[1]. In the next stage, chemicals were developed using semiconductor structures for photovoltaic production. These chemicals are a kind of textile dye obtained by the efficient use of nano technology and in additional This dye is a kind of flexible device. Organic semiconductors are used in the production of the latest photovoltaic materials. Conductive polymers, dyes, pigments, liquid crystals are used in the production of photovoltaic materials with organic semiconductors.

All of these can be applied to the surface of a fabric in textile printing machines. Thanks to this technology, it is possible to produce fabrics that can produce electricity from the sun.

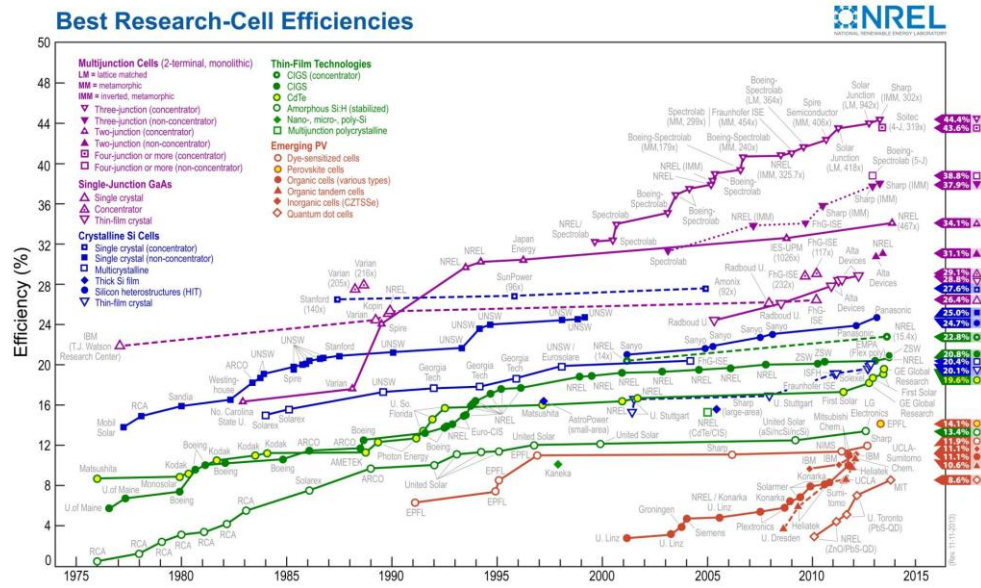

Figure 1. Efficiency of photovoltaik panel types.

The efficiency of the photovoltaics given under the thin flim layer is given in green color.

### Solar Energy Panels

Today, single-crystalline silicon solar panels, which are used as the most efficient solution in the industry, are produced in heavy blocks that do not stretch and bending. The working efficiency of these panels made of pure silicon is 19 to 40 percent. On the other hand, it is preferred because the multi-functional crystal panels with lower efficiency are relatively cheaper. This comparison shows us that the cost is preferred to efficiency. Photovoltaic fabrics also have the potential to gain importance in this reason. Classic solar panels are produced from heavy solar cells with thick frames. In order to use these panels on the roofs, a strong infrastructure is required on the roofs and mostly metal is used for this infrastructure. In addition to the weight of the panel, this metal infrastructure is an important problem especially in roof solutions. Thus, cost of solar energy panels incereas easily. In order to overcome this specific problem, new lightweight and flexible solar panels formed from silicone layers, which are newly emerging on thin films, can be used on the outer surface of the buildings. Flexible solar panels reduce the cost of logistics and installation, making it a more useful alternative than conventional panels[2].

### Fliexible Fotovoltaik Structurries

Plastic-based (membrane) flexible solar panels that can be laid like a wallpaper on the roof are a new phase in panel technology. Membrane based flexible panels, which are started to be produced very widely, can be purchased easily. They do not require a mechanical connection element for mounting flexible (membrane) panels. They are also more resistant to meteorological effects. Membrane based panels are important for defense industry besides commercial purposes. As military activities are carried out in remote areas away from the electricity grid, the energy required for the use of smart ammunition can be provided with these flexible panels, or it is easy to transport.



Figure 2. Membrane flexible panels.

### Fotovoltaik Fabrications

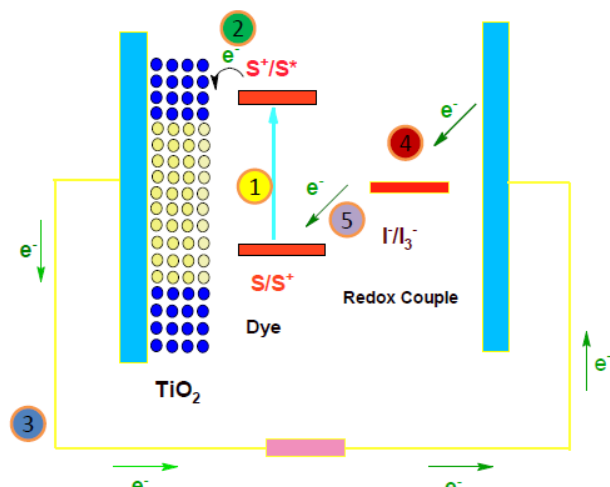

Figure 3. Working schema of photo voltaik paints.

Stages of electricity generation at DSSC: electron transport begins with stimulation of paint, electron transporting, accumulating electric charge, electrolyte reduction and regeneration of dye ille biter.

Photovoltaic textiles can be obtained by processing of photovoltaic materials on fabrics as well as by the production of fibers, yarns having this property. Photovoltaic textiles can be obtained by processing of photovoltaic materials on fabrics as well as by the production of fibers, yarns having this property. Wisconsin-Madison University Chemical Department' scientiests syntezed fotovoltaik textile dye and textile printing application, seen in fig 2 [3].



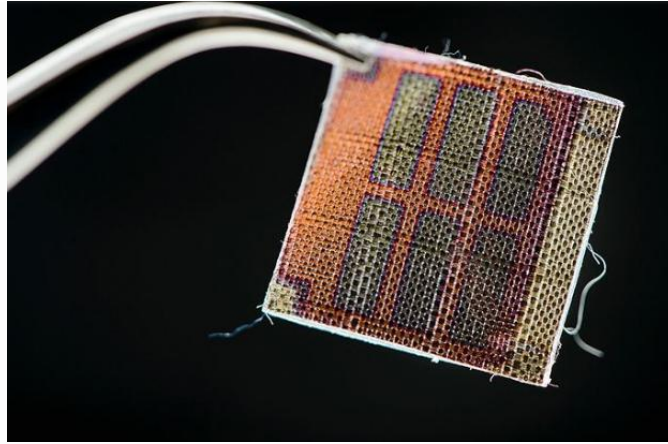

Figure 4. Wisconsin-Madison University improved photovoltaic fabric.

In 2005, Chittibabu et al. Managed to produce photovoltaic fibers with nanomatrix as a composite structure.

This composite structure of photovoltaic effect; the inner layer of carrier fiber (1 nanomatrix structure surrounding the fiber surface (2), conductive intermediate layer (3), wires for the transmission of electricity generated (4), highly transparent conductive section (5), outer protective layer (6) contain, see in fig 3 [4].

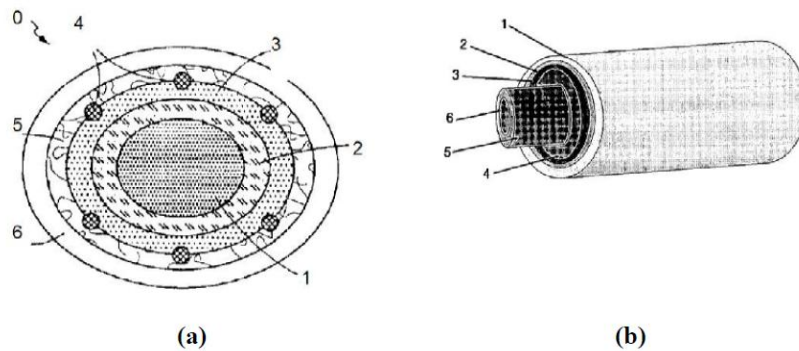

Figure 5. a) Cross section of photovoltaic fiber, b) The structure of photovoltaic fiber.

Imec from Belgium works on a photovoltaic fabric using a fabric in which conductive and insulating flat ribbon fibers are intertwined [6]. (fig 4)



Figure 6. Photovoltaic fabric produced by Imec.

photovoltaic papers can be produced in printers using photovoltaic ink. It is aimed to use this kind of paper which can produce between 10 and 500 watts per meter [7] (figure 5).



*Figure 7. Georgia Institute of Technology works on photovoltaic structure.*

Georgia Institute of Technology works on photovoltaic structures in complex carbon based fabrics. The advantage of this type of fabric is that the surface properties in photovoltaic applications can produce good electricity, high chemical resistance in acidic and basic environments, and the disadvantage is that it has a relatively low conductivity[8]. This structure is still under investigation, (figure 6).



*Figure 8. Photovoltaic fabric developed in the Georgia Institute of Technolog.*

Hynek, Campbell and Bryden used flexible silicone-based photovoltaic paint on the front surface of a tie of cotton-satin fabric. There is a paint protective layer on the surface of the tie. Despite the disadvantages of this tie, such as brightness, tie difficulty and width, it is stated that these problems can be overcome through digital textile printing technique [9], figure 9.



*Figure 9. Photovoltaic tie made with satin fabric.*

ITU and 9 Eylul University in Turkey with photovoltaic electricity generation nano coating on polyester fabric was carried out with the cooperation. This technique using second generation technology does not contain silicon, figure 8.

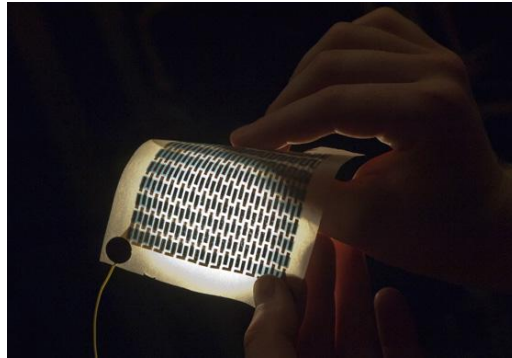

*Figure 10. development of photovoltaic fabric in Turkey.*

Researchers at the University of Florida have succeeded in developing nanotechnology-containing copper strips that can be placed into the fabric with the fineness and flexibility to be placed. These strips are micro devices that are capable of generating and storing electricity from the sun. These structures are self-charging fabrics The most important feature of this structure is; the solar panel and the battery are connected in a weft, figure 9.

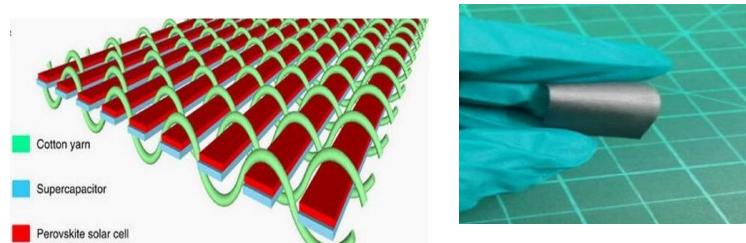

*Figure 11. The solar panel based on weaving technique developed at the University of Florida.*

Paint-based photovoltaic materials in these studies can be easily applied on fabric with the printing methods used in textile. The photovoltaic fabrics obtained in this way are technically called DSSC. The process for the production of DSSC is shown in figure 10.

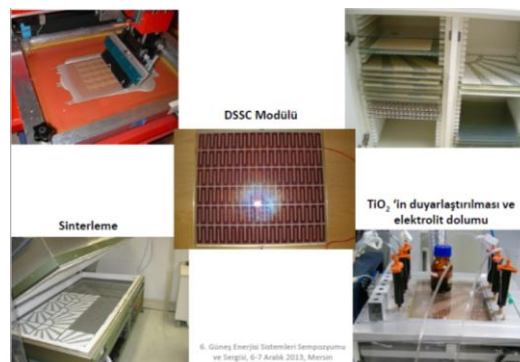

*Figure 12. Production steps of photovoltaic fabrics by printing method.*

## CONCULATIONS

Due to the fact that photovoltaic materials can be produced in liquid form, solar panels have become applicable to a wide variety of surfaces. In addition, fiber production with photovoltaic materials has also been realized. As a result of these developments, solar panels can be easily produced in plastic, fabric and paper form. In order for standard solar panels to be installed on the building roofs in the old countries, the column must be strengthened.

Old cities such as Belgrag, Prague, Budapest, Rome, Zagreb have narrow streets and old building structures, so the implementation of standard panels in these cities can bring enormous problems. If we can produce textile-based solar power plants, depending on the lightness of our country can easily use the roof. In the field of alternative energy sources, a large number of large budget researches are carried out in the world. Solar energy is particularly noteworthy in this context. Due to the advantages of flexibility and easy installation, a large number of researches are carried out in the field of photovoltaic fabric production. In this paper, the most important of these are discussed in a very brief way.

## REFERENCES

- [1] <http://dergi.ituieee.com/teknik/fotovoltaiik-hucreler>
- [2] <https://popsci.com.tr/catilardaki-gunes-bahceleri>
- [3] Youhei Takeda, Trisha L. Andrew, Jose M. Lobez, A. Jolene Mork, and Timothy M. Swager An Air-stable Low Bandgap n-Type Organic Polymer Semiconductor Exhibiting Selective Solubility in Fluorous Solvents.
- [4] Chittibabu, K., Eckert, R., Gaudiana, R., Li, L., Montello, A., Montello, E., and Wormser, P., 2005, "Photovoltaic Fibers", Patent US 6,913,713 B2.
- [5] <https://www.extremetech.com/computing/142755-the-first-flexible-fiber-optic-solar-cell-that-can-be-woven-into-clothes>
- [6] <https://www.pv-tech.org/guest-blog/a-fresh-look-at-assembling-pv-modules-a-woven-fabric-interconnects-and-enca>
- [7] <https://www.3ders.org/articles/20150629-paper-thin-3d-printed-solar-cells-to-provide-affordable-electricity-for-unlit-rural-areas.html>
- [8] Bu, I.Y.Y., Hu, T.-H., 2016. The role of various carbon nanomaterials for dyesensitized solar cells applications. *Sol. Energy* 130, 81–88.
- [9] Hynek, J.S. , Campbell, J.R. ve Bryden, K. M. (2005). Application of digital textile printing technology to integrate photovoltaic thin film cells into wearables. *JTATM*, 4(3).

## PROJECTS IN EDUCATION - UNIFORM DESIGN

**Dr. Mátra KISFALUDY, Dr. Éva HOTTÓ,**

Hungary, Óbuda University

Faculty of Light Industry and Environmental Engineering

Product Design Institute

[kisfaludy.marta@rkk.uni-obuda.hu](mailto:kisfaludy.marta@rkk.uni-obuda.hu); [hotto.eva@rkk.uni-obuda.hu](mailto:hotto.eva@rkk.uni-obuda.hu)

### ABSTRACT

*Our Product Design Institute has several years of experience in project-based education, including all kinds of design tasks, like uniform design.*

*We have much experiences already, but new tasks always require new, innovative solutions that the education needs to adapt. This article presents some major projects, from the design till the real implementation. Based on our practice-oriented training we can fulfill the design-oriented product design and product development project tasks, as well. Tasks done by the same method will yield the expected results depending on student attitudes, intentions and individual habits.*

*The industrial design engineering students are structured into groups of up to 3-4 students to work together on a current topic. The tasks are based on theoretical and practical knowledge they learnt so far. The best performers of the project, building on their experience, continue their work as theses or as dissertations for Scientific Student's Conference (TDK).*

*Uniform design is a complex project task that integrates functionality and unique visual elements, as well as comfort and safety.*

**Key words:** *uniform design, project task*

### INTRODUCTION

The change of the theoretical and practical education to the benefit of the latter has changed the existing thematic education system and the curricula refreshed under the new training and output requirements already reinforce this practice-oriented training. In project tasks, the "learning by doing" principle prevails, which is currently being studied by both instructors and students.

In the framework of Erasmus mobility, students studying abroad have been able to experience the strength of group work since the change of the regime, which teaches autonomy, decision-making and adaptation, but this process has only begun to become more frequent in Hungary through exchange programs. The diverse personality and educational level of students with different nationalities and cultures has given new impetus to the host institutions of higher education.

This fact is also tinged with the fact that the Z generation, whose members are 10-21 year old teenagers and young adults, appeared. The everyday part of their lives is used by the Internet, the virtual world is used as a living space. They use smart tools, and they are filled with new, mostly visual information all day. As a result, they are, in some respects, much more mature than earlier those of young people of this age, but metacommunications are not their strength, or they have difficulties formulating their feelings and thoughts.

Even during the earlier Y generation, we could learn the meaning of multitasking or cumulative media consumption, which is more and more valid for this younger age group. Two or more activities are performed in parallel on a tablet, smartphone, and computer, which results in the sharing of attention.

This is a phenomenon especially for young people, ignoring the fact that we are all capable of multiple activities at the same time, if not necessarily in the media and the virtual world. (Pais, E.R. 1987.)

The old values, emotions and attitudes are changing constantly, which the instructors have to respond to and one of the best opportunities is to participate in joint project tasks with students.

During the useful transfer of knowledge, young people should use the advanced problem-solving skills, their excellent technical abilities and their good abstraction.

## **GOALS AND OBJECTIVES**

The project tasks within the Integrated Product Design course aim at a complex product design, well-organized teamwork, effective collaboration between students and precise assignments. The team working in this case, an awareness-raising process, the final product of which leads to beneficial results in terms of marketing and socially usefulness. It is also a positive result that students gain experience of work in the group, adaptation to others and reconciliation of the individual to achieve a common goal.

Project-oriented task is a coherent, complex theoretical and practical work that goes beyond specialist subjects and involves several disciplines. Includes all criteria for marketing, ergonomics, design and technology.

## **THE PROCESS OF METHOD**

The interdisciplinary approach guidelines apply when setting up a method of design processes.

For effective co-operation and efficient work, team members must be selected to give everyone the best knowledge to accomplish this task. The complexity of the tasks justifies 3 or 4 students. The teacher can assist in knowing the qualities of individuals and their role in the project task. Some students create visual graphics lightly and expressively, while others are good at computer aided technical documentation. Busy students are more willing to carry out market research, surveys, while others rather analyze them or collect legislation and regulations. Such an ideal team can work dynamically, while over-representation of any role needs to be modified.

Defining the subject of the task plays an important role in the absence of a specific order or tender, since it is necessary to find a fictitious solution to an existing problem. (Bardossy, 1994)

However, the process is identical in both cases:

- Setting up a strategy and outline a team image
- Collection and analysis of information
- Setting up a list of requirements (main and supplementary levels)
- Designing a concept
- Individual planning
- Common selection
- Design and documentation
- Presentation
- Review
- Exhibition / presentation.

The task is half-yearly, though sometimes there are shorter 1-2 months projects. The group members are initially distrustful to each other, even their friends do not know each other in common work. Discussions are difficult and the teacher's instructions are important.

Then they slowly understand the weight of responsibility, find out the values and great opportunities of the task, start working and encouraging each other.

The biggest compromise arises when the final product line is to be compiled from individual designs and there will be one or two students who do not have any of his or her own design selected. Thus, these students will only strengthen the group in later times, but their plan will not be implemented.

This situation can be solved by widening the product range and getting everyone at least one of their own plans, which is self-confidence and team-strengthener at the same time. Discussions, evaluations and decisions are therefore ongoing weekly.

## PROJECT CASES

The industrial product design engineers have been facing the challenges of project tasks since the launch of the specialization year after year and have achieved good results with their work.

In specialisation of clothing and accessories in such a semester students receive a formal garment design, often based on real orders.

### Workwear Design Competition for the Filling Stations of MOL

One of our project task was a competition, announced by the MOL Nyrt. The purpose of the collection of workwear and formal wear was to create a uniform image appearance that reflects the value of the user, such as quality, customer-centered approach, creativity and dynamism.

There were general requirements:

- a uniform appearance consistent with the image features,
- comfortable, practical, durable and safe to wear,
- taking into account economic (cost) and environmental aspects,
- fulfillment of hygiene and safety regulations,
- changing ambient temperature takes into consideration the climate conditions of the surrounding countries.

Employees of the MOL Ltd. (workshops, shop-sellers, gastro-dealers, car washers) work- and formal wear referred to three brands: MOL (new logo), INA and Slovnaft.

The new logos of MOL Ltd. and the dynamic arches of the various elements of the charging stations gave several ideas for design. All team of the year enjoyed brainstorming and a vigorous design process despite the strict limitations. The groups have inspired each other and have produced plans that have not yet been seen. (Figures 1-2) The software used to handle the final dossier was well-suited to their age. They had a lot of experience after the presentation, though they did not win the race, but were well-experienced in the motivational power of joint work.



1. figure: MOL Workwear Designs (Jackets, cardigans, caps)



2. figure: Color variations of trousers and jackets for the three brands.

### Competition for the Hungarian Workwear Design

It was also a competition for the first Hungarian Workwear Design (MMD) bidder to announce a bid for the cultured, innovative workplace dressing. One of them was the design of a uniform for personal and property protection, which differs from that of the Armed Forces of the Republic of Hungary and the uniforms of other public employees. In addition to guard, patrol and money carrier exercises, it was also necessary to design for more elegant banking, commercial and reception functions. The other category was the world of Supermarkets, with a specific grocery and daily article where students had to work out a workwear and uniforms collection for bartender, merchant, cashier and manager functions. (Figure 3)

Beside the material qualities, technology solutions, ergonomic aspects and standards, design and aesthetic appearance were also the main aspects of design. Based on the multi-page, all-in-one requirement list, students have designed collections in both categories and implemented prototypes. The good team spirit, the teamwork that worked together gave the expected results, but they also received significant help from their tutors.

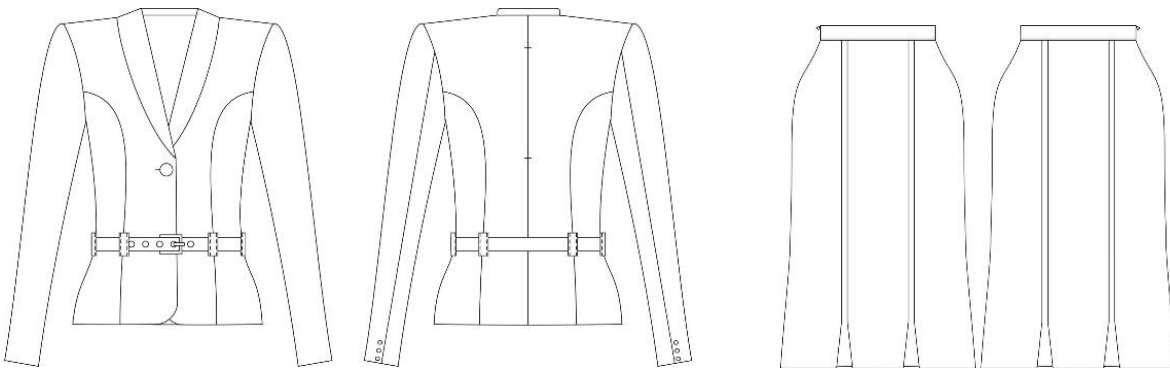

3. figure: Product plan for supermarket leaders



However, the process was so long that they had to continue the work during the summer, but in the end two teams of 4-4 students were awarded prizes in both categories and exhibited at the Goldberger Textile Collection conference room. (Figure 4)



*4. figure: Uniforms with many functional detail solutions*

The computer skills of the teams were still less confident, so the emphasis was put on execution and they all took an active part in it.

### **Uniform design for the FUTURA**

Our other major project was the formal clothing designed for the employees of FUTURA Interactive Natural Science Center in Mosonmagyaróvár. FUTURA is a refurbished and enlarged building of a 300-year-old cereal store, which introduces visitors to the four levels of the laws of physics and nature with the help of constantly evolving technical tools.

Staff meeting with most visitors is the treasurer, the information and the young demonstrator team. A distinctive signaling system had to be applied in the design of their clothes, because many people are asking questions or help. By leaving the inner structure of the old mill, the four levels were chosen separately in the four colors in the emblem. The students have designed the uniform so that the crew dressing between the levels can be varied. Replacing of colored belts, braces and name badges ensure the combination of the uniformly print patterned T-shirts and black trousers. For warmer weather in short sleeves and cold weather, long sleeved shirts, light raincoats and umbrellas with emblems were recommended by designers. (Figure 5)

From the previous task, these dresses were made by large domestic manufacturers such as Styl Fashion Ltd. and Eurohod Fashion Ltd. At this level, however, only 3 enthusiastic students were left to complete the project task.



5. figure: Details from the documentation

## CONCLUSIONS

The relationship between the students and their teachers is changing, they are involved in projects that can bring the novice even to the trainer, too. The new generations now prefer the online education and the "doing the learning" principle. Recognizing this has led to the introduction of project-based education in higher education as well as training being given priority practice-oriented. It is necessary to build on the excellent technical and practical perception of students, their good problem-solving skills. In addition to creativity, empathy, cooperation and compromise skills play an important role.

Good examples of this are case studies through which well-valued experiences have been gained by both students and trainers alike. By ending each project, not only the senior teacher reviews, but also the students themselves. They evaluate each other's work, activity and motivation by secret ballot. Apart from the fully democratic, equal percentage work assessment and the "I worked the most", apart from the biased vote, 80% of students can objectively object to each member of the group. Their opinion counts in the final grade, which is often the same as the teacher's judgment.

## REFERENCES

- [1] Aronson, E. (1987): *Social Being, Economics and Legal Publishing*; Pais, E.R.: *Y and Z generation as employees of the future*. In: Government Office website [online]
- [2] [http://www.kormanyhivatal.hu/download/2/18/60000/Y és Z generáció mint a jövő munkavállalói.pdf](http://www.kormanyhivatal.hu/download/2/18/60000/Y_és_Z_generáció_mint_a_jövő_munkavállalói.pdf), (2017. 04.21.)
- [3] Bárdossy, I. (1994): *Projects in Education. Projects in Education special course periodical*. JPTE Department of Pedagogy, Pedagogical Viewer, 1994/1

## FIGURES

Works of Industrial Design Engineers of RKK of Óbuda University

## **BIOLOGICAL WASTEWATER TREATMENT USING INNOVATIVE EQUIPMENT AND MATERIALS**

**Moga Ioana Corina (\*), Dontu Octavian, Pricop Floarea, Iordache Ovidiu, Petrescu Gabriel**

DFR Systems SRL, Drumul taberei 46, Bucuresti, Romania

[corinamoga@yahoo.com](mailto:corinamoga@yahoo.com)

University POLITEHNICA, Splaiul Independentei 313, Bucuresti, Romania

[octavdontu@gmail.com](mailto:octavdontu@gmail.com)

The National Research & Development Institute for Textiles and Leather, Bucuresti, Romania

[pricop44@yahoo.ca](mailto:pricop44@yahoo.ca)

The National Research & Development Institute for Textiles and Leather, Bucuresti, Romania

[iordacheovidu.g@gmail.com](mailto:iordacheovidu.g@gmail.com)

DFR Systems SRL, Drumul Taberei 46, Bucuresti, Romania

[dfr@dfr.ro](mailto:dfr@dfr.ro)

### **ABSTRACT**

*Wastewater treatment represents an important problem of the textile industry. It is very well known that the pollutants discharged by the textile industry have a major negative impact upon the environment. The authors analyze and propose improved biological treatment for textile wastewater treatment plants. An improved Mobile Bed Biofilm Reactor (new material and shape for biofilm carriers and new aeration system) is presented by the authors. The new material proposed for the realization of the biomedica supports is a mixture between low density polyethylene and talcum. The new material has excellent hydrophilic properties and the biofilm adhesion to the new material increased with 200% compared with the biofilm carriers made from high density polyethylene.*

*Key words: biofilm carrier, wastewater treatment, textile, electro-erosion, mobile bed biofilm reactor*

### **INTRODUCTION**

The textile industry is one of the most polluting industries worldwide in terms of the number of chemicals produced and released. Wastewater produced by the textile industry is too toxic to be released in nature and has to be treated. As the municipal wastewater treatment plants (WWTPs) cannot handle textile wastewaters, textile industry factories use different WWTPs. The textile wastewater treatment plants are complex and in most cases custom-designed for specific emitters and chemicals. The most important criteria for judging these WWTPs are: removal efficiency and costs (investments and operational). Water treatment technologies have to keep pace with a fast-evolving textile industry (in terms of materials and methods). Fast response in water treatment technologies is key to balance legal pollutant requirements with the economical sustainability of the textile industry.

The most frequent and abundant pollutants produced by the textile industry include (in no specific order): dyes, sulfide, enzymes, starch, ammonia, aniline, organic carbon, disinfectants, insecticides, NaOH, surfactants, fats, waxes, enzymes, peroxide, metals, salts, solvents, chlorinated compounds, acetate, softeners, urea and formaldehyde. In this paper we focus on advances in the removal of ammonia nitrogen ( $\text{NH}_4^+\text{-N}$ ) and the fraction of organic carbon that can be lowered by aerobic respiration and called Biological Oxygen Demand (BOD).

## THEORY

The biological treatment that uses biofilm carriers has as a basic principle the development and fixation of a huge population of bacteria on an artificial mobile support. In the specialty literature, this treatment process is found under the name Moving Bed Biofilm Reactor (MBBR) (Ødegaard H., et al., 2013). Due to the large area of exposure and biofilm fixation, biological treatment processes are faster compared to the classic biological active sludge treatment. The soil footprint of MBBR-type treatment plants is greatly reduced because in such systems the amount of biofilm developed per volume unit is much superior to activated sludge treatment. Further improvement of MBBR requires development on new biofilm carriers with the increased surface and selection of consortia of microorganisms capable of more efficient nitrogen compounds removal in aerobic and/or anoxic conditions.

Moving bed biofilm reactors are mainstream in water treatment (Torresi E.S. et al., 2016). These biofilters bacteria form biofilms, that are attached to solid-phase carriers also known as biomedica or biofilm carriers (Levsteck M. and Plazi I., 2009). Most commonly, these are made of plastic substrates such as high-density polyethylene (HDPE) or polyvinyl alcohol (PVA) (Barwal A. and R. Chaudhary, 2014). Water flows through the bioreactors and the living cells transform or accumulate pollutants. In some MBBRs, the solid substrates are made of plastics with density close to 1 g/cm<sup>3</sup> thus insuring easy mixing and efficient wastewater treatment. Common applications for MBBRs include ammonia- and nitrite-oxidation (nitrification), oxidation of organic carbon, sulfur- and iron-oxidation, and removal of heavy metals. If elimination of toxic chemicals is desired as well, the biofilm carriers are harvested, and biomass is washed away whenever necessary.

The efficiency of nitrifying biofilms in bioreactors was studied extensively (Picurell M.P. et al., 2016). Studies have shown that many factors (thickness of biofilms, water flow rate, ammonia concentration and oxygen concentration) control the efficiency of nitrifying (Torresi E.S. et al., 2016). Also, negative correlation was found to exist between the concentration of DOC and the efficiency of nitrifying biofilms (Hu J. et al., 2009). Hence, efficient ammonia oxidation can be obtained by combining various types of biofilters, some that oxidize DOC first, followed by some that oxidize ammonia. The most common ammonia-oxidizing bacteria in MBBRs are from the genera *Nitrosomonas*, *Nitrospira* and *Nitrosococcus* (Burrell P.C. et al., 2001). The majority of autotrophic nitrifiers are mesophilic, i.e. their growth rate is best in the range of (10-25)°C and diminishes at 40°C; but for temperatures less than 10°C less research is available.

Free-moving biofilm carriers (which are used in MBBBs) are efficient at pollutant removal (Pham H.S. et al., 2008). Some of the authors developed an efficient biofilm carrier for nitrifying biofilms (Patent RO123174/2008). Biofilm carriers with a specific density of 0,96 g/cm<sup>3</sup> are maintained in aerated water tanks basins to support biofilm growth. The authors recommend using for biofilm carriers to represent (40-50)% of the water volume in bioreactors. For the developed biofilm carriers, the specific surface area of the packing is about 850 m<sup>2</sup>/m<sup>3</sup> of the bulk packing volume. By using the patented biofilm carrier, the authors have obtained the following results relative to activated sludge methods:

- a) more efficient nitrification;
- b) higher treatment efficiency;
- c) lower energy consumption;
- d) rapid re-population of the slime after the removal of the biological film;
- e) ease of operation;
- f) small bioreactors' footprint; and
- g) capacity to treat high loaded wastewaters.

In MBBRs, large quantities of air are bubbled through wastewaters that contain dissolved organic substances in open aeration tanks.

Air is being supplied to the WWTPs using air blowers driven by asynchronous electric motors, and this system is the largest energy consumer in WWTP, accounting (50 - 80)% of all WWTP energy consumption, value varies depending on aeration technology used and WWTP's geographical location. An oxygen process optimization is therefore imposed with the purpose to reduce the operation costs, to guarantee an efficient and reliable treatment in such installations (Ødegaard H., et al., 2013). During the last years, the fine bubbles aeration systems were often used to improve the oxygenation process performances.

The methodology for the design of MBBR aeration systems using free moving plastic biofilm carriers is the least documented mechanical design approach process. MBBRs use an engineered aeration system consisting of stainless-steel pipe diffusers, manifold (or submerged air header), down pipes, and air-flow control valves. The so-called medium-bubble diffusers have relatively large circular orifices (i.e., when compared to membrane diffusers) situated along the underside which are less susceptible to scaling and fouling. These diffusers have slightly more efficient oxygen transfer efficiency than coarse-bubble diffusers, which is further enhanced by the presence of free moving plastic biofilm carriers. Operational experience has proven that medium-bubble diffusers require less maintenance than fine-bubble diffusers. The medium-bubble diffusers are characterized by lower oxygen transfer efficiency than fine bubble diffusers because the larger expelled bubbles travel through the water column rapidly and have a lower surface-to-volume ratio (Pham H.S. et al., 2008).

In MBBR aeration systems the air is introduced with the help of pipes connected to a blower. The bubbles are generated by the small orifices drilled in the pipes situated at the bottom of the biological basins. The air bubbles are generated by the small orifices drilled in the pipes situated at the bottom of the biological basins. Diffusers typically used in MBBRs are 25 mm diameter stainless-steel pipes with 1 mm - 4 mm diameter orifices spaced 35 - 100 mm along the underside of the diffuser pipe (Johnson C. and Boltz J.P., 2013). Placing the orifices too close together will lead to uneven air flow distribution inside the pipe diffuser, and placing the orifices too far apart leads to cost prohibitive application.

## METHODS

The authors propose a new installation (Figure 1) for the determination of the wastewater treatment efficiency within the textile industry. Four biological treatment technologies will be tested by some of the authors. Laboratory installation has one principal tank where textile or synthetic wastewaters may be introduced.

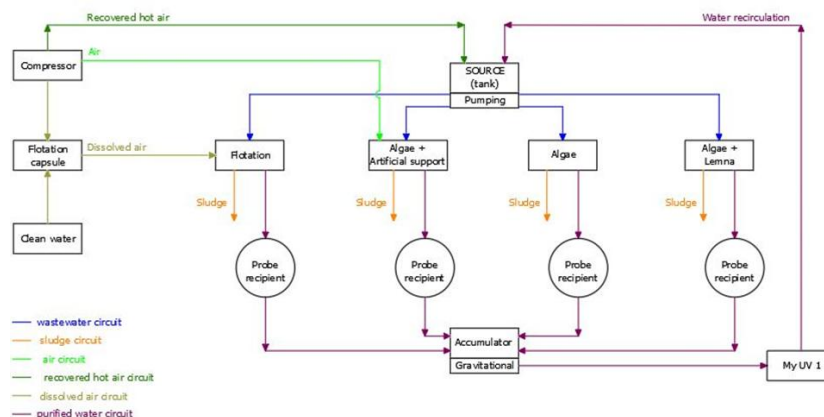

Figure 1. Biofilm carriers used for the present experiments (dimensions, aspect and introduced in a municipal wastewater treatment plant).

From this principal tank, 4 different treatment lines that are disposed in parallel starts.

These four lines will have the same flow-rate. In this way the 4 biological treatment stages will have the same inflow (quantity of wastewater, the same pollutant concentrations and the same temperature). The four biological lines are: Line 1 – tower type installation with biological treatment based on Duckweed and algae; Line 2 – biological treatment with algae and biofilm carriers; Line 3 – biological treatment with algae; Line 4 – biological treatment with biofilm carriers and flotation.

## FINDINGS

The laboratory installation was conceived designed (Figure 2) and realized. The research team will make different experiments to determine the treatment efficiency. Probes from all the 4 treatment lines will be prevailed and compared. The best biological treatment technology will be further tested in real conditions. In the first stage the experiments will be done with synthetic wastewater. Several wastewater indicators will be determined: COD, BOD, nitrate, nitrite, ammonia, heavy metals etc.

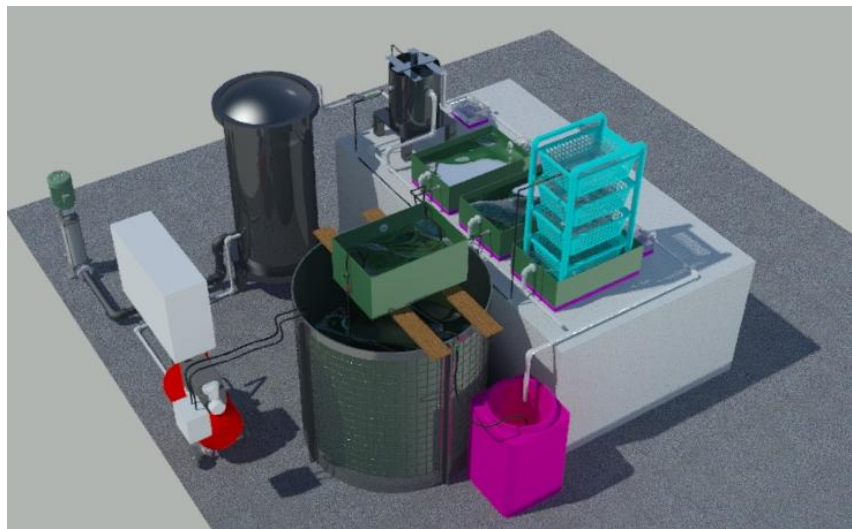

*Figure 2. Biofilm carriers used for the present experiments (dimensions, aspect and introduced in a municipal wastewater treatment plant).*

Most of the existing biofilm carrier are realized from high density polyethylene (HDPE), but this material has hydrophobic properties. Moga I.C. and Petrescu G. have obtained good results at using MBBR technology for various applications and holds a patent request for the model of a novel biofilm carrier (A/01052/07.12.2017) (Figure 3), that resulted from WaterWorks 2015 project, entitled “Advanced Biotechnology for Intensive – Freshwater Aquaculture Wastewater Reuse” - ABAWARE project.

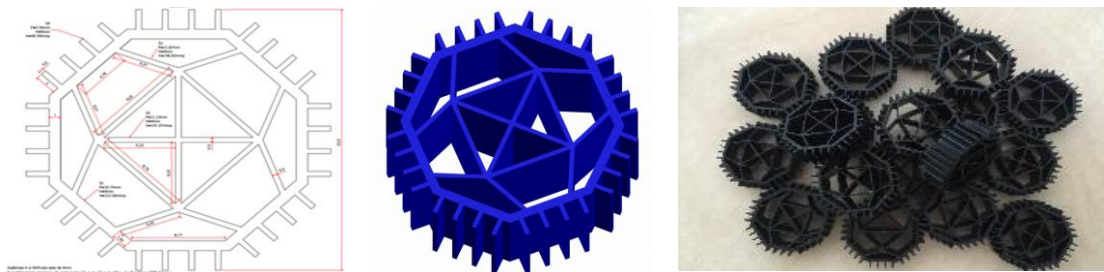

*Figure 3. New patented biofilm carriers (Moga I.C. and Petrescu G, 2017)*

During the ABAWARE project a new material was proposed for the realization of biomedica supports, namely a mixture between low density polyethylene and talcum.

The new material has excellent hydrophilic properties. Biofilm adhesion to the new material has increased considerably by more than 200% compared to biofilm carriers made exclusively from HDPE (Moga I.C. et al, 2018). More than this, the new biofilm carrier needs a lower quantity of material to produce 1 m<sup>3</sup> biofilm carriers, and the total costs are decreased with 30%.

## **DISCUSSION**

The researches will continue with the development of a novel aeration systems. Another innovation in wastewater treatment consists in the utilization of stainless-steel pipes with holes smaller than 1 mm that are used as air diffusers. In the aerated MBBRs aeration systems consisting of stainless-steel pipe diffusers, pipes, blowers and airflow control valves are installed. The new diffusers, with small holes, are realized by special procedures (laser drilling or electro-erosion). By using smaller holes, the air bubbles are smaller and a better transfer of dissolved oxygen from air to wastewater is realized. This biological treatment stage can be used to lower the concentrations on nitrogen compounds, phosphorus and organic matters. In this way the authors propose a new material and equipment to be used in textile wastewater treatment plants for an increased efficiency and decreased investment costs.

Some of the advantages of using an electro-erosion are specified in literature (Kucukturka G. and Cogunb C., 2010): realization of complex shapes that would otherwise be difficult to produce with conventional cutting tools; extremely hard material are processed with very close tolerances; very small pieces can be shaped where conventional cutting tools may damage the part from excess cutting tool pressure; there is no direct contact between tool and work piece; delicate sections and weak materials can be machined without any distortion; a good surface finish after the drilling.

The aeration systems with small holes has a major problem. Due to the presence of the suspended solids the aeration system can clog. The authors propose an innovative solution – the utilization of an ultrasound system to prevent the system's clogging. During the last decade, the ultrasound technique was implemented in wastewater treatment. It is well known that the application of ultrasonic technology has been receiving wide attention by the world in wastewater treatment and environmental remediation areas. The use of ultrasound technology is shown to be very promising for the degradation of persistent organic compounds in wastewater as it is proven to be an effective method for degrading organic effluent into less toxic compounds. Nevertheless, the ultrasound technology was not applied to prevent aeration diffusers clogging.

## **CONCLUSION AND IMPLICATIONS**

The worldwide researchers are searching for new cost-effective treatment technologies. The authors recommend the MBBR utilization in textile wastewater treatment processes because it meets the requirements of an efficient and cost-effective technology. So far, wastewater treatment plants all over the world are using MBBR treatment stages but the researchers are actual and constantly are seeking ways to increase the efficiency. MBBR has proved the efficiency of reducing especially BOD and ammonia, in small tank volumes. Innovations in MBBRs are still possible and the authors will try to develop a further biological technology for low temperatures.

## ACKNOWLEDGMENTS

This work was supported by a grant of the Romanian National Authority for Scientific Research and Innovation, CCCDI – UEFISCDI, project number COFUND-WATER WORKS ERANET 2015-ABAWARE (1), within PNCDI III.

This work was supported by a grant of the Romanian National Authority for Scientific Research and Innovation, CCCDI – UEFISCDI, project number COFUND-MANUNET III-FUNCELL, within PNCDI III.

## REFERENCES

- [1] Barwal A., Chaudhary R. (2014). To study the performance of biocarriers in moving bed biofilm reactor (MBBR) technology and kinetics of biofilm for retrofitting the existing aerobic treatment systems: a review. *Reviews in Environmental Science and Bio/Technology*, 13(3), 285-299.
- [2] Burrell P.C., Phalen C.M., Hovanec T.A. (2001). Identification of Bacteria Responsible for Ammonia Oxidation in Freshwater Aquaria, *Appl Environ Microbiol.* 67(12), 5791-5800.
- [3] Hu J., et al., (2009). Effect of organic carbon on nitrification efficiency and community composition of nitrifying biofilms, *Journal of environmental sciences*, 3, 387-394.
- [4] Johnson C., Boltz J.P. (2013). Aeration system design in integrated fixed-film activated sludge (IFAS) and moving bed biofilm reactors (MBBR) using stainless steel pipe diffusers, manifold, and down pipes, WEFTEC 2013.
- [5] Kucukturka G., Cogunb C. (2010). A New Method for Machining of Electrically Nonconductive Workpieces sing Electric Discharge Machining Technique, *Machining Science and Technology: An International Journal*, 14(2), 189-207
- [6] Levstek M., Plazi I. (2009). Influence of carrier type on nitrification in the moving-bed biofilm process, *Water Science & Technology* 59(5), 875-882.
- [7] Moga I.C., Ardelean I., Donțu O.G., Moisescu C., Băran N., Petrescu G., Voicea I. (2018). Materials and technologies used in wastewater treatment, *IOP Conference Series: Materials Science and Engineering*, 374(1).
- [8] Ødegaard, H. (2013). State of the art of wastewater management in the Nordic countries, NORDIWA Conference, 8-10 October, Malmo, Sweden.
- [9] Patent request no. RO CBI A/01052/07.12.2017, Biofilm carrier.
- [10] Pham H., Viswanathan S., Kelly R.F. (2008). Evaluation of plastic carrier media impact on oxygen transfer efficiency with coarse and fine-bubble diffusers. *Proceedings of the Water Environment Federation Technical Exhibition and Conference*, Chicago, IL.
- [11] Piculell M., Welander P., Jönsson K., Welander T. (2016). Evaluating the effect of biofilm thickness on nitrification in moving bed biofilm reactors, *Environmental Technology*, 37(6), 732-743.
- [12] Torresi E., Fowler J.S., Polesel F., Bester K., Andersen H.R., Barth F.S., Plósz B.G., Christensson M. (2016), Biofilm Thickness Influences Biodiversity in Nitrifying MBBRs - Implications on Micropollutant Removal, *Environ. Sci. Technol.*, 50(17), 9279-9288.



## BUYERS APPROACH WHEN SELECTING A FASHION PRODUCT

**Nikola Zivlak, J. Đukić, D. Joksimović, A. Milosavljević, J. Stepanović**

\* Emlyon business school Asia,

\*Technical Faculty "Mihajlo Pupin", Zrenjanin - Đure Đakovića bb, 23000 Zrenjanin

\* Faculty of Technology Leskovac, University of Nis - The scholarship holder of the Ministry

e-mail: [jelenadjukic09@gmail.com](mailto:jelenadjukic09@gmail.com)

### ABSTRACT

*Every company strives for the most successful production and the best placement of its brand on the market. In order for a company to succeed, it is necessary to collect information from consumer behaviour analysis. This paper describes factors affecting consumers as well as criteria consumers apply when selecting clothing products.*

**KeyWords:** *factors, product, customer, consumer*

### 1. INTRODUCTION

Fashion is intended for consumers. Consumers "consume" fashion, and manufacturers, whether its creators or initiators seek to achieve economic benefits. Most consumers respond positively to the new fashion. Whether they will buy it depends on many factors, one of them being purchasing power. Manufacturers who are the creators of the new fashion have to consider many elements for a starting point that are very important in creating a new clothing product: lines, colors, tones, shapes (classical, complex), otherwise the fashion they produce will not come to life. It's impossible to fulfill all of the consumer requirements and wishes, but manufacturer should meet demands of the most of consumers.

There are more ways for people to satisfy their spiritual needs, and one of those is emergence of a new fashion line. The eternal desire for changes of any kind, even those in terms of owning and using of products, marketing and design have to make use of thoughtfully. That is the initial factor for adoption and making success of a new fashion line, because if there was no spiritual need for change, every new fashion line would have little chance for success. Most consumers want changes to the products they own and use, but the real change happens when a new product appears and gets acquired, the one that marks introduction of a new fashion line.

### 2. consumer

A consumer is a social and cultural being, who is at the same time an individual, a member of a family, a citizen of a country, representative of a nation, and similar. Consumer is also a person who has the money and will to buy a new product. Consumers get differentiated according their age, level of education, taste, personal income and mobility.

As there is no unique behavior for every consumer when buying a product, it is important to observe and study behavior of consumers. This could partially help predict their approach to the shopping process.

### 3. consumer behavior factors

There are various factors that influence consumers' behavior while deciding on buying specific product, and these factors play significant role while shopping. The three basic factors are social, personal and psychological. Each of these three factors has its own subsets of factors shown in Table

Table 1: Influential factors while shopping

Social factors	Personnal factors	Psychological factors
Culture	Motiv and motivation	Information processing procedure
Socialization	Attitudes	Learning process
Social position	Lifestyle	Group communication
Social groups	Personnal values	Personnal influence
Family	Knowledge	
Situational factor		

#### 3.1. Social factors

Figure 1 shows social factors that influence consumer to make purchasing decision. Consequently, consumers often opt for products already owned by particular member of the society.

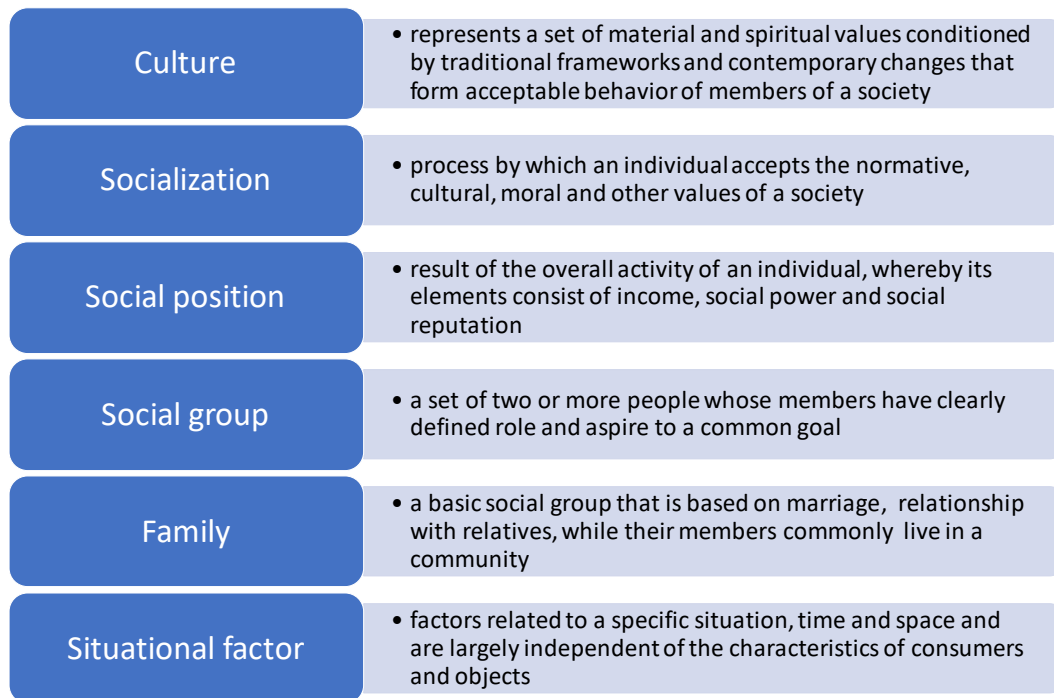

Figure 1: Subgroups of social factors

Every consumer, depending on the culture to which he belongs, in his own way makes a decision about buying a particular product. Consumers, depending on the amount of income, adjust to the products they will buy. Also, education and occupation have significant role to play in forming desire for a particular product, as consumers often believe that a given product will bring them certain status in a society. Since a family consists of several members, each member in its way has a role in shopping.

This role can be influential, initiative, as well as member being buyer himself. Situational factors are important because it depends on them whether certain product will be purchased or not. Consumers can often change their buying decision due to the physical environment of the store, if the store is not neat and clean, social environment, and even the gifts given while shopping.



*Figure 2. Shopwindow of the fashion brand "H&M"*

### 3.2. Personal factors

Personal factors are such that the environment and society do not have too much influence on them, but it's about factors which person possesses as a consumer. Personal factors consist of: motives and motivation, attitudes, lifestyle, personal value, knowledge and similar.

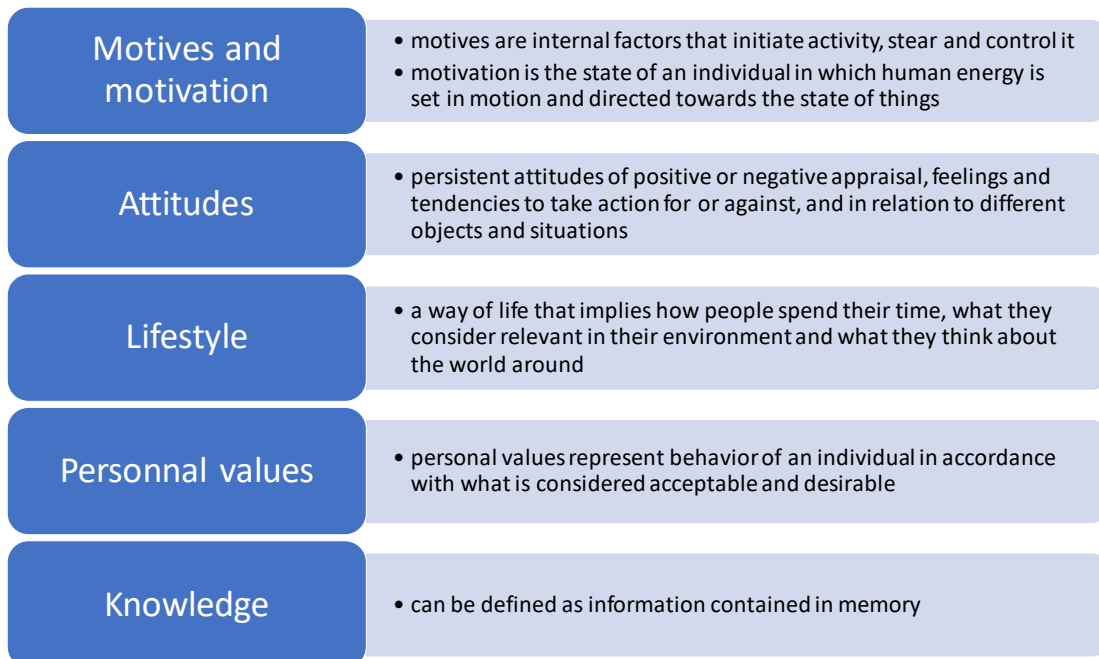
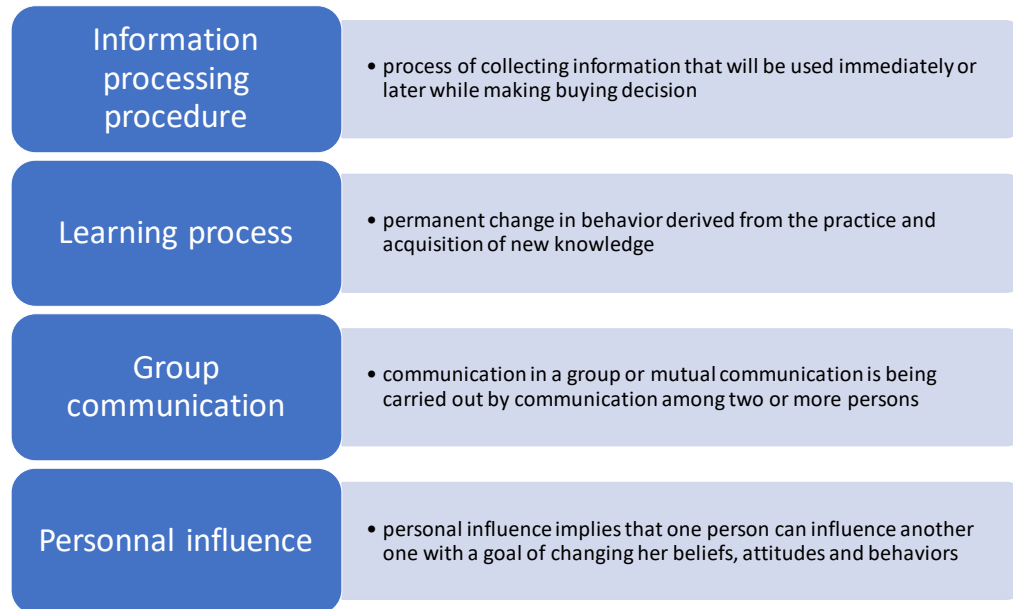

*Figure 3. Subgroups of personal factors*

### 3.3. Psychological factors

Psychological factors are those associated with the psychological state of a consumer and which influence decision to buy particular product.

Below Figure 4. contains a list of psychological factors which show subfactors that make up psychological factor of a consumer behavior.



*Figure 4. Subgroups of psychological factors*

### 4. Consumer's buying criteria

Every manufacturer on the market wants his product to be the first customer choice when shopping. Studying buyer psychology reveals what actually attracts a buyer and what influences most of his opinion for a specific product. Though clothing has basic purpose to protect the body from cold and outer influences, the question arises as to why people have every day need for ever more buying of clothing items. Factors that influence this issue are:

- inadequate or spent supplies
- dissatisfaction with the existing range of clothing assortment
- aspiration for something new and different
- changing the environment of life requirements
- change of financial conditions
- marketing activities

People buy products, above all to meet their needs and desires, but only 25% of their decisions relate to logical needs.

Every buyer buys based on buying criteria while shopping. If buying a clothing item, buying criteria for a buyer can be price, comparison of quality against price, appearance, brand, packaging. Interestingly, while shopping, in most cases one or two criteria will be crucial. If for example, a consumer sets criterion on looks and the comfort while finding a product with a good price, but his comfort, in addition to good looks doesn't fit, it is hard to expect he will decide for the purchase.

Clothing today represents an important way of communication among people. The essence of this is desire of people to represent themselves to the others over clothing.

Basic assumption is that consumers do not buy clothes only due to their functional attributes, but also because of the feelings that product or the brand raise by the consumer.

## 5. Shopping decisions

Shopping process is generated far before the buyer arrives at the point of sale, and shopping itself is a result of customer needs. Most of everyday consumer decisions, such as buying in the shops are simple. However, buying clothing items requires much more time and considerable psychological efforts.

Decision-making processes can be classified into multiple groups starting from a routine group, through a limited to an extended group.

Routine shopping is when consumer buys an item that he is familiar with and which doesn't require effort to collect information, so even excludes psychological involvement. Consumers are basically loyal to a single brand and buy routinely without thinking.



*Figure 5. Fashion brand "H&M" logo*

Limited shopping is process that takes place when a consumer buys a new brand in a recognizable product category. This requires additional time and research of information, incl. psychological involvement.

An extensible shopping process in which a consumer buys an entirely unknown product in an unknown product category, so he needs a substantial amount of information and more time during selection. So, consumers must inform themselves, therefore psychological involvement here is on the maximum.

## 6. Factors which buyer is ready to recognize while selecting a clothing item

The purchasing power doesn't mean that consumer will for sure make purchasing of a particular product. Also, purchasing power is largely reflected in the readiness of consumer to buy. There are number of factors that affect consumer's readiness: economic conditions, income, price, family size.

Quality and Guarantee - in reality, production of fault free clothing is not possible. The goal is to prevent possible mistakes completely or to minimize them. Over time, customer expectations have increased and resulted in buyers not forgiving any kind of mistakes. The customer today wants products that are durable, easy to maintain and therefore there is no tolerance to the faults, even if they are negligible.

The price of the clothing item is one of the key factors influencing the selection when buying. If appropriate fashion line and price are combined, then this is considered to be the right combination.

It is important for some customers to buy the cheapest product while others are interested in the value they will get for the purchased product. Price is a highly emotional or psychological category that can be defined as the value that the buyer is willing to pay for a product.

Novelties - novelties attract number of consumers. The consumer is proving himself with the novelties, i.e. showing off he is up to date with fashion. Watching new collections on fashion shows and television is an additional motivation for buyer to shop.

Location - People often opt for retail outlets that are on less busy locations and where, in turn, there is a smaller crowd (secured parking lot, faster service). "Outlet" centers are far away and are located outside major cities, but they attract customers for their affordable prices.

Shop design - a big role here has design of the showroom, music, lighting and so on. Buyers of clothing items get attracted by shops where clothing is always nicely arranged, where the discounted prices are well marked, and above all the buyer will be drawn by a well-designed showroom.



*Figure 6. An example of fashion brand "GRAZIA" showroom*

Product features - consumer considers importance of one or two attributes and consequently buys certain product. This can be majority of the same designer's garment, the same brand, the garment of desired origin. Of course, if it matches expected quality, price and comfort. These features are important to the buyer because features he recognizes don't present a burden to him while thinking, thus he can safely buy the product.

The brand - wishing to meet their needs, buyers buy certain brand they expect to meet their expectations. The brand is at the same time price and quality value of a garment. In addition, buyer chooses the brand for psychological reasons, such as showing off in the public, purchasing power and showing ability to afford more expensive product.

The power of spending - meaning of spending is to buy one product and to get two for free. Consumption and shopping are also evidence of power in society.

Simplicity - customers want products that are easier to maintain, which means easier to iron, wash at lower temperatures, wear resistant, and similar.

Product Promotion - through advertisement companies assure consumers of product quality and other benefits so consumers can easier opt for shopping. Types of advertising material are: TV commercials, radio advertisements, billboards, flyers and posters.

Selection of Assortments - In the selection of assortment, buyer looks at seasonality in which it is possible to wear the item throughout the year (spring / summer, autumn / winter), but also expected lifecycle of the product, which is related to the quality in sense that a certain item can last for more years.

Consumer Provisioning Services - consumer store offers a range of services with the goal of attracting consumers in order to increase his satisfaction, convenience of use, and assure consumer to purchase future products.

## 7. CONCLUSION

To attract interest in fashion, marketing is needed to promote the product to a broader audience. Exchange is a process whereby two or more organizations or individuals give and receive something of value, in this case fashion items.

Marketing experts need to understand people to meet their needs. Consumer reactions are the ultimate test of whether a marketing strategy will succeed. It is widely adopted that a good marketing strategy sells everything thus fashion too, it is only necessary to choose appropriate strategy to succeed. Diverse tests are performed such as demographics, geography, psychography, and behavior analysis that considerably help marketing understand of who and what is sought in the world of fashion. Today, marketing is tightly connected with consumers and follows them at every turn. It strives to keep in touch with customers through various channels, discounts, loyalty services, and even services to third parties that their clients are respecting, such as assisting the poor and so on. In that way, they penetrate awareness of the buyers and they automatically become promoters of particular brand, service or something else.

To date and further on, fashion and marketing have been and will be part of man's life. Every day, new trends emerge and new fashion styles are being adopted, which at an increasing speed want to make some items redundant so new ones can come, and so on.

Shopping should be pleasant feel and joy. Consumers are craving daily for dream models to fulfill them. However, when they get what they want, this product becomes no longer desirable. Urge is created for the purchase of a new product and so on in circle. It is believed there will always be comparison between the imagined and the purchased product, as it will often not meet needs of the individual. This is precisely the point of buying or retail, because imagined and real, often is not the same and thus creates new desire for re-consumption.

## 8. REFERENCES

- [1] Desnica,E., Nikolic, M., Industrijski dizajn, Tehnicki fakultet "Mihajlo Pupin", Zrenjanin,
- [2] 2012.
- [3] <https://sr.wikipedia.org/sr-el/Moda>
- [4] <https://sr.wikipedia.org/sr/Бренд>
- [5] [https://sr.wikipedia.org/sr/Маркетинг\\_микс](https://sr.wikipedia.org/sr/Маркетинг_микс)
- [6] <http://www.mcb.rs/blog/prostor-prodaje-proizvod/>
- [7] <https://scindeks-clanci.ceon.rs/data/pdf/0354-3471/2012/0354-347112021570.pdf>
- [8] <https://www.slideshare.net/ggland1/ponasanje-potrosaca-modnog-proizvoda>
- [9] <https://zir.nsk.hr/islandora/object/efst:1738/preview>
- [10] [http://www.academia.edu/24889705/modeli\\_ponasanja\\_potrosaca](http://www.academia.edu/24889705/modeli_ponasanja_potrosaca)
- [11] <https://repozitorij.unin.hr/islandora/object/unin%3A1810/datastream/PDF/view>
- [12] <http://vssp.edu.rs/wp-content/uploads/2017/03/Prirucnik-Ponasanje-potrosaca.pdf>

## **BODY PROPORTIONS OF SPORTS FOOTBALL POPULATION AND THEIR IMPACT ON GARMENT CONSTRUCTION**

**Darko Ujević<sup>1</sup>, Blaženka Brlobašić Šajatović<sup>1</sup>, Bin Yu<sup>2</sup>, Yunchu Yang<sup>3</sup>**

Faculty of Textile Technology University of Zagreb<sup>1</sup>

Zhejiang Sci-Tech University of China<sup>2</sup>

School of Fashion Design & Engineering, Zhejiang Sci-Tech University<sup>3</sup>

### **ABSTRACT**

*Research of body proportions and determination of differences between football players and untrained population form the basis of this work. The paper presents the differences in body proportions. It also presents the results of the anthropometric study conducted on a sample of 102 tested football players aged between 18 and 26 years with an average playing experience of 10.7 years and 102 test persons of the untrained population. Anthropometric measurements of the test subjects were conducted using the conventional method according to the ISO and EN standards. The results showed an increase in average leg circumference. The aforementioned values were found in tested football players. They resulted as a consequence of extensive sports activities and affect garment construction.*

### **1. INTRODUCTION**

Anthropometry (Greek word: Anthropos-man and metron-measure) refers to the measurement of a human individual. Anthropometry is the method of anthropology, deals with the measurement of body's sake and the relation between dimensions, i.e. the proportion of individual parts of the body, and it is of great importance in the area of the construction of clothing. Anthropometry is a method of anthropology, dealing with the measurements of the human body and the relation between dimensions, i.e. proportions of individual body parts and is of great importance in the field of garment construction [1,2]. The objective of anthropometry is to quantitatively characterize the morphological and physiological characteristics of body that differ within and between a given populations. Garment manufacturing and garment fit to the body physique are the subject of continuous research. Monitoring changes and insights into the actual amounts of body dimensions of a particular population open up numerous possibilities of influence on the manufacture and design of clothing [3,4].

Anthropometric measurements of test subjects are carried out by using conventional body measurement method and conventional measuring equipment as well as contactless body measurement system or 3D body scanner. Measuring instruments for anthropometric measurements and measurement procedures have been developed in such a way as to provide accurate and reliable measurements of the population for the purpose of garment construction (textile, clothing and footwear industry) as well as for the needs of other industries, medicine and pediatrics, educational institutions, etc. [ 5,6].



## **2. Garment fit**

Clothing that looks good on a person is also the one that fits well. One of the biggest problems with the selection of clothing is dissatisfaction with garment fit. Anthropometric studies of collecting data on body measurements of a representative population sample take a lot of time and data such as fit of different garment types is not available.

The objective evaluation of the concept of garment fit is defined according to certain parameters related to garment construction, i.e. correct garment joining with seams meaning that the garment has appropriate size without straining on any part of the body and that a person can move normally and feels comfortable. Garment patterns were made according to standard. However, such a garment does not fit the whole population. For example, in the trained population, there are deviations in somebody measurements compared to the standard size clothing system causing garment unfit. The populations of trained groups differ in body physique in relation to the untrained group, and there is a need for partial modification in garment design in order to achieve garment fit, fashionability and functionality.

### **2.1 Garment sizing systems**

In the clothing sizing system, individual body dimensions define garment size and the scale becomes a specific standard. The standard characterizes body shape based on two circumference dimensions – basic and dependent variables. Furthermore, the classification of the data on body measurements results in their grouping in garment sizes of the analyzed population. On the basis of this information, clothing size charts with information on the differences in body shape and body proportions are created and make the clothing sizing system. When establishing clothing sizes, it is necessary to determine the way of their labeling which is also prescribed by the standard [7]. Garment sizing system is a fundamental starting point for industrial garment production because it provides an insight for garment manufacturers to understand the real needs of consumers. Therefore, manufacturers who place products on the market of individual countries should have access to data describing body sizes and shapes of the target market population [8,9].

## **3. Overview and features of ISO and EN standards for size designation of clothes**

Various clothing and footwear designation systems are still being used around the world, causing a number of doubts and difficulties for potential buyers and manufacturers. This is extremely present in cases of launching the same products onto the market where customers, due to the lack of understanding the designation of garment and footwear sizes often fail to recognize the size designation or it does not provide sufficient qualitative information. As is often the case, one product has several similar size labels, creating a complete confusion. Customers can very rarely fully recognize all the information that the size label contains since it is most often known only to the experts.

Additional customer confusion is caused by the fact that each product is designed and constructed only for its characteristic features and has a variety of accessories for the comfort of wearing and achieving a particular shape. Additional customer confusion is caused by the fact that each product is designed and constructed only according to its characteristic features and has a variety of allowances to provide wear comfort and to achieve a particular shape. Only in special cases, body measurement fits the measurement found on the body, and the basis for determining clothing size is, as a rule, just body measurement. Thus, in most cases, body measurement and garment measurement significantly differ.

Because of all that it is in the interest both of customers and manufacturers of clothing and footwear to agree on unique ways to label garment and footwear sizes, which would be equally applied in all markets and provide customers with clear and unequivocal information, and enable manufacturers to achieve potentially higher sales.

By updating standard ISO 3635 and by publishing standards ISO 8559 and ISO 9407 the foundations for a unique definition of human body measurements for the purposes of the clothing and footwear industry, and thus for performing anthropometric measurements and size designation system have been laid.

### 3.1 Proposal of the new Croatian garment sizing system and size designation of men’s clothes

Croatian Technical Report HRI 1148:2012 refers to anthropometric measurements and sizes used in the industry of different types of clothing and footwear.

The purpose of this report is:

1. to provide a thorough understanding of the classification of clothing according to size in order to improve the suitability and fit in the Republic of Croatia
2. to optimize the number of garment and footwear sizes especially designed for the Croatian population
3. to facilitate the technical cooperation between manufacturers, sellers, and customers as end consumers.

As the basic starting point for a new method of designating clothing and footwear size in the Republic of Croatia according to EN, there are eight types of male body based on the difference between chest and waist girth. The system and method of designation specified in European standards 13402-1, 13402-2 and 13402-3 have been accepted.

*Table 1. Type of male body*

	<b>Body type</b>	<b>Type definition</b>	<b>Waist girth– Chest girth</b>
1	Type A – very slim	Difference -20	From -22 to -18
2	Type B – slim	Difference -16	From -18 to -14
3	Type C – normal	Difference -12	From -14 to -10
4	Type D – sturdy	Difference -8	From -10 to -6
5	Type E – sturdier	Difference -4	From -6 to -2
6	Type F - corpulent	Difference -0	From -2 to +2
7	Type G – paunchy	Difference +4	From +2 to +6
8	Type H – markedly paunchy	Difference +8	From +6 to +10
9	Type I – very paunchy	Difference +12	From+ 10 to + 14

### 4. Importance of anthropometry in the field of kinesiology

By using surface analysis of athletes' bodies, it can be established that athletes of certain sports branches and disciplines are characterized by specific morphological structure [11].

Morphological anthropometry is used for scientific research of morphological characteristics of the body, and in sports it allows the selection of candidates for a particular sport, assessment of general body development, etc. Anthropometric dimensions of the athlete's body are based on morphological status that results from heritage, adaptation to the influence of various factors, training and diet.

Adoption of the International Biological Program in the mid-60s 20<sup>th</sup> marked a major shift in human study, in terms of anthropometric research. The adoption of the International Biological Program in the mid-60-ies of the 20<sup>th</sup> century marked a major breakthrough in the study of human beings with regard to anthropometric research. Within the scope of standardization, a list of 39 measurements used in anthropometric research activities was adopted.

Anthropometric studies of sports population do not use all the prescribed anthropometric measurements because all the measurements do not require special attention in the sport sector in order to determine the composition of athlete's body and body constitution. Some anthropometric measurements, which are not part of the International Biological Program (IBP) such as the determination of skin folds, are especially important in sports for assessing the percentage of body fat, i.e. estimation of obesity, whose themes are dealt with by a large number of authors from the field of kinesiology.

In the field of kinesiology special attention is given to the variability of somatotypes in the athletes' population and the proportion of somatotypes in overall sports performance. This topic was pursued by Philostrat Flavio, who describes the connection of the somatotype of an athlete in relation to the sports discipline he deals with. The higher the level of performance in a certain sport, the more noticeable is the diversity of the athlete's physique [17]. The importance of somatotype for sports performance was the topic of many researchers who described the body physique of successful athletes. Carter is one of the scientists who studies somatotype differences and similarities between some types of sports and considers the somatotype of athletes to be one of the parameters important for success in sports [12].

#### **4.1. Anthropometric characteristics of football players**

Football is one of the most popular sports games of today. According to the criterion of the structural complexity, football belongs to the group of poly structural complex sports. In order for a football player to be able to perform football tasks, he must have the required level of endurance (aerobic and anaerobic), strength (maximum strength, explosive power, speed power) and speed (reaction speed, start speed, maximum speed) [13].

Previous research related to anthropometry engaged in team sports is based on the analysis of athletes in the group as a whole and on the analysis of the player's position, comparison of the trained and untrained population.

It is evident from an overview of the available literature on the morphological characteristics of athletes or anthropometric characteristics of football players that these subjects are studied by a number of authors, and that there is a significant number of scientific papers (Table 3). It can be concluded that the anthropometric characteristics of football players are used to establish football player performance, and changes in anthropometric characteristics under the influence of football game are studied. By reviewing the literature it can be concluded that there are differences in anthropometric characteristics of football players with regard to player position [14].

*Table 2. Overview of anthropometric characteristics of football players according to authors*

<b>Research</b>	<b>Level/country</b>	<b>N</b>	<b>Height</b>	<b>Weight</b>
Adhhikar and Kumar	National team /India	2	172.4±1.8	65.1±1.3
Al-Hazzaa et al.	Premier league/ Saudi Arabia	7	174.0±6.7	68.2±4.4
Arnason et al.	First league /Iceland	8	172.2±2.3	68.6±8.7
Aziz et al.	National team/Singapore	23	175.0±6.0	65.6±6.1
Bunc and Posta	First league /Czech	15	182.5±5.5	78.8±2.1
Casajus	LaLiga/ Spain	15	180.0±8.0	78.5±6.45
Chamari et al.	U-19	34	177.8±2.1	70.5±6.4
Chini et al.	Premier league/Hong Kong	24	173.2±4.6	67.7±5.0
Drust et al.	Students/England	7	178.5±5.0	72.2±5.0
Ekblom	Allsvenskan/Sweden	24	178±5.0	72.2±5.0
Heller et al.	First league/Czech	21	183.9±5.4	7.02±4.7
Matković et al.	First league/Croatia	52	179.1±5.9	77.5±7.9
Puga et al.	Primeira liga/Portugal	15	186.0	84.4
Rahkila and Luthanen	Veikkausliiga/Finland	31	180.4±4.3	713±6.8
Rhodes et al.	Olympic games	16	177.3	66.7

By studying anthropometric characteristics between the trained and untrained population it was found out that the body height of football players did not differ significantly from the average male population of the same age, but lower body mass and lower value of fat tissue were observed.

By comparing the results of body height with earlier research data an increase in the average body height of football players was noticed. Differences between the trained and untrained population in some other anthropometric measurements, such as an increase in the shoulder width of football players as well as leg circumferences, were observed. The increased values of the leg circumference are the result of a higher amount of muscle mass and with regard to a lower amount of fat tissue, which is understandable in view of an increased body activity. By observing similarities and differences in the anthropometric characteristics of football players with other types of athletes, such as basketball players, there are significant differences [15]. When performing motoric tasks in different types of sports, specific groups of muscles for sports activities were activated. The anatomical analysis of football players gives information about which parts of the football player body are most engaged and most vulnerable. The most threatened joints of football players are knee, ankle joint, spine, and especially the lumbar and cervical part of the spine. The most loaded muscles and muscle groups are extensor and adductor muscles of the upper leg (thigh) and flexor and extensor muscles of the lower leg [16].

## 5.METHODS AND TEST SUBJECTS

The study included a total of 204 men aged between 18 and 26. For the purposes of this study, the conventional method of anthropometric measurements was used to determine anthropometric sizes for young men (football players and untrained population) in accordance with standards ISO 3636 and ISO 8559 [17-20]: 102 football players had an average playing experience of 10.7 years and 102 untreated test subjects of the general population. 19 variables, relating to the examination of the fit of men's trousers, were investigated.

## 6.RESULTS

*Table 3. Basic parameters of the distribution of body measurements of football players and untrained group of the general population*

Body measurements (cm)	Football players(cm)			Untrained population (cm)			Difference	t	p
	$X \pm SD$	Min	Max	$X \pm SD$	Min	Max			
Body height	180.3±5.64	166.5	193.0	179.4±5.25	170.0	190.0	0.87	1.437	0.152
Chest girth	92.8±5.42	81.0	108.0	92.7±8.03	74.0	113.5	0.19	0.250	0.803
Waist girth	79.1±6.11	68.0	104.0	81.5±9.32	61.0	110.0	-2.46	-2.809	<b>0.005</b>
Hip girth	97.5±4.94	84.0	112.0	98.3±7.07	86.0	119.5	-0.78	-1.152	0.250
Trouser length	111.9±5.84	90.0	125.0	110.0±5.76	90.0	120.0	1.88	2.916	<b>0.004</b>
Crotch length	83.8±4.31	72.5	98.5	83.1±4.45	69.0	96.0	0.73	1.437	0.136
Buttock depth	26.0±4.42	17.0	35.0	25.3±4.52	15.5	35.0	0.69	1.395	0.164
Waist height	110±5.87	97.0	125.0	108.9±4.98	96.0	119.0	1.01	1.677	0.094
Hip height	91.0±4.55	79.5	102.5	90.5±4.69	75.0	105.3	0.51	0.989	0.324
Knee height	52.2±3.20	42.0	59.8	51.9±3.69	42.2	63.0	0.38	0.987	0.324
Ankle joint height	5.1±0.74	3.4	7.0	5.4±0.85	3.5	7.5	-0.34	-3.835	<b>&lt;0.001</b>
Hip depth	21.0±1.87	17.0	26.0	20.9±4.31	12.0	33.0	0.07	0.199	0.842
Total buttock length	73.2±6.76	57.0	92.0	72.7±9.62	48.0	97.0	0.47	0.513	0.608
Inner thigh length	33.6±3.39	25.0	42.0	31.9±4.14	18.5	42.0	1.70	4.049	<b>&lt;0.001</b>
Upper thigh circumference	57.1±3.86	47.0	69.0	55.0±5.66	42.0	74.0	2.16	4.008	<b>&lt;0.001</b>
Mean thigh circumference	52.1±3.35	45.0	62.0	47.1±5.51	45.0	62.0	5.02	9.910	<b>&lt;0.001</b>
Circumference under the knee	34.8±2.07	30.0	43.0	34.9±2.55	26.5	43.0	-0.04	-0.156	0.876
Knee girth	38.5±2.0	34.0	46.0	38.3±3.06	33.0	51.5	0.22	0.779	0.436
Lower leg circumference	37.3±2.66	28.0	44.0	36.7±3.40	27.0	49.0	0.63	1.868	0.063

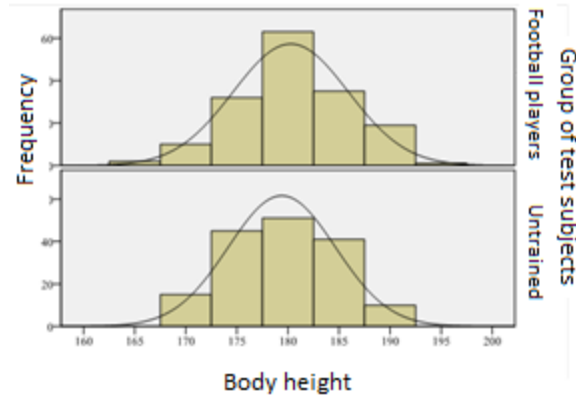

Figure 1. Body height distribution of football players and untrained population

The results showed that footballers are slightly higher, but not significantly, the chest girth is almost equal to that of untrained subjects, and the hip girth is somewhat smaller. The biggest and significant statistical difference is in the upper thigh circumference, mid-thigh circumference, whose value is higher in football players and in the waist girth which is lower in football players. However, due to the determined value of a statistically significant increase in the mid and upper thigh circumference in football players, it is necessary to model trousers in this field. In order to meet the criterion “trouser fit” as an article of clothing, along with construction and main body dimensions, additional body measurements are very influential, one of them being mid-thigh circumference.

Modeling the trousers is based on the previously determined analyses and differences in body measurements between the two mentioned groups of test subjects. The mid-thigh circumference is according to the result analysis 5 cm higher on average than in the untrained group of test subjects; in accordance with that a necessary redesign of the basic pattern of men’s trousers was carried out in this field, Figure 2. [20].

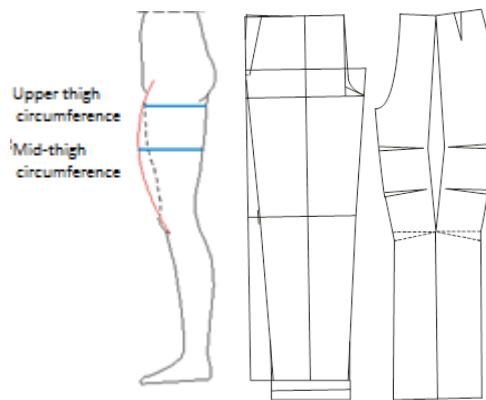

Figure 2. Modeling of the basic pattern of men's trousers

## ACKNOWLEDGEMENT

Results shown in this paper were supported by the bilateral Croatian –China project “Anthropometric measurements for woven and nonwoven clothing”.

## REFERENCES:

- [1] Ujević D. i sur.: Hrvatski antropometrijski sustav - Podloga za nove hrvatske norme za veličinu odjeće i obuće, Tekstilno-tehnološki fakultet Sveučilišta u Zagrebu, Zagreb, prosinac 2006., ISBN 953-7105-09-1
- [2] Brlobašić Šajatović B.: Investigation of body proportions of trained and untrained population as factor in the processes of garment construction, PhD Thesis, University of Zagreb, Croatia, 2014.
- [3] Ashdown S.P.: Sizing in Clothing: Development effective sizing system for ready-to-wear clothing, Woodhead Publishing in association with The Textile Institute, Cambridge, 2007.
- [4] Ujević D. at al.: Theoretical aspects and application of croatian anthropometric system, Tekstilno-tehnološki fakultet Sveučilišta u Zagrebu, Zagreb, 2010., ISBN 978-953-7105-28-0
- [5] Ujević D. i sur.: Hrvatski antropometrijski sustav – Fakultetski priručnik, Tekstilno-tehnološki fakultet Sveučilišta u Zagrebu, Zagreb, 2006., ISBN 953-7105-10-5
- [6] Ujević D., Szivovics L. Dimec : Prikaz istraživanja i usporedbe sustava odjevnih veličina, Tekstil, 12, 2003., 611-620
- [7] Winks J.: Clothing sizes, International standardization, The Textile Institut, 1997., ISBN 1 870812 72 7
- [8] Chun – Yoon, Jasper, C.R.: Garment sizing system – An International comparison, International Journal of Clothing Science and Technology, 5, 1993, 28-37
- [9] Aldrich W.: History of sizing system and ready-to-wear garment, Sizing in Clothing, Developing effective sizing for ready-to-wear clothing, The Textile Institut, Woodhead Publishing Limited, Cambridge, England, 2007., 1-56, ISBN-13: 978-1-84569-034-2
- [10] Antropometrijski sustav – Mjerenje tijela i označavanje veličina odjeće i obuće, Hrvatski tehnički izvještaj, HRI 1148:2012, HZN, veljača 2012., ICS 01.040.61:61.020
- [11] Mišigoj Duraković Marjeta: Kinantropologija, Biološki aspekti tjelesnog vježbanja, kineziološki fakultet Sveučilišta u Zagrebu, Zagreb, 2008., ISBN 978-953-6378-73-9
- [12] Barr, I.S., McCargar, L.J., Crawford, S.M.: Practical use of body composition Analysis in sport. Sports Med 1994; 17, 277-282.
- [13] Matković B., Mišigoj – Duraković M., Matković B.: Morfološke karakteristike vrhunskih hrvatskih nogometaša, Hrvatski športskomedicinski vjesnik, 13, 1998., 1-5
- [14] Mihačić V., Ujević B.: Kondicija nogometaša, dostupno na: <http://www.hns-cff.hr/file/document/file/255-Kondicijanogometasa.pdf>, pristupljeno u veljači 2013.
- [15] Barišić V., Bašić D.: Nogomet – skripta za praćenje nastave iz predmeta nogomet, dostupno na [http://www.kif.unizg.hr/download/repository/NOGOMET - Skripta\\_gotova.doc](http://www.kif.unizg.hr/download/repository/NOGOMET - Skripta_gotova.doc), pristupljeno u veljači 2013
- [16] Sporiš G.: Efekti situacijskog polistrukturalnog kompleksnog treninga na morfološka, motorička, situacijsko-motorička i funkcionalna obilježja, Doktorska disertacija, Kineziološki fakultet Sveučilišta u Zagrebu, Zagreb, 2007., dostupno [http://bib.irb.hr/datoteka/372599.Goran\\_Spori\\_doktorska\\_dizertacija.doc](http://bib.irb.hr/datoteka/372599.Goran_Spori_doktorska_dizertacija.doc), pristupljeno u veljači 2013.
- [17] HRN ISO 3635:2008 – Označavanje veličine odjeće – Definicije i postupak mjerenja tijela (ISO 3635:1981)
- [18] HRN ISO 8559:2012 – Oblikovanje odjevnih predmeta antropometrijska istraživanja – Tjelesne mjere (ISO 8559:1989)
- [19] HRN EN 13402 (1-3 dio) : 2008, Označavanje veličina odjeće – 1. dio: Nazivi, definicije i postupak mjerenja tijela (ISO 3635:1981, MOD; EN 13402-1:2001); 2. dio: Primarne i sekundarne dimenzije (EN 13402-2:2002) i 3. dio: Mjere i intervali (EN 13402-3:2004)
- [20] Ujević D., Rogale D. i Hrastinski M.: Tehnike konstruiranja i modeliranja odjeće, Treće dopunjeno i prošireno izdanje, Tekstilno-tehnološki fakultet Sveučilišta u Zagrebu, Zrinski d.d. Čakovec, 2010., ISBN 978-953-7105-36-5

## HAND AND SEWABILITY OF WOVEN FABRICS FOR TAILORED GARMENT

**Maja Jankoska\*, Goran Demboski**

University "Ss. Cyril and Methodius", Faculty of Technology and Metallurgy, Skopje,  
Macedonia

Department of Textile Technology

e-mail: [maja@tmf.ukim.edu.mk](mailto:maja@tmf.ukim.edu.mk)

### ABSTRACT

*The effect of fabric structure variation on fabric handle and garment sewability has been investigated. Results obtained have shown that particular variation of fabric structure can influence mechanical properties of the fabric under low loads particularly tensile and shearing properties, which can in turn affect garment total hand value and sewability. The difference in selected primary hands and total hand greatly influenced selection of fabrics for summer or winter suits.*

**Key words:** fabric hand, sewability, woven fabric, fabric objective evaluation

### INTRODUCTION

Making high quality clothing of attractive appearance and minimal number of defects is the goal of every clothing factory. The quality of clothing is not influenced merely by operator's technique, but also by the selected fabric properties (Kawabata S., Niva M., 1999). The development of the system for objective evaluation of the mechanical properties of the fabric under a small load enabled the possibility of evaluation of fabric hand and the clothing appearance value. Eventually, significant step was made in connecting the mechanical properties of the fabric and garment processability (Kawabata S. et al., 1992). On the basis of the mechanical properties of the fabric, the criteria for rejecting or accepting fabrics were proposed, as well as toll for anticipating problems in the process of garment making (Ly N.G. et al., 1991). As a result of extensive research findings, the objective evaluation system for fabrics began to be used as a means to increase manufacturing productivity and improve clothing performance (Cheng K.P.S. et al., 1996). Some research in this area has been focused on defining the connection between fabric hand, processability and fabric structure in order to optimize these parameters both (Vassilidais S. et al., 2005, Leung M.Z. et al., 2002). Applications of objective measurements in fabric evaluation, quality assurance in garment making and product design were suggested by Postle, Kawabata and other researchers (Postle R., Mahar T. J., 1982, Postle R. et al., 1983).

KESF characteristics of eight fabric groups structured by fiber content, fabric construction and special finishing treatment were investigated by Gong, R. H., Mukhopadhyay S.K., 1993. They found that fabric construction has some influence on fabric stiffness, but not on hysteresis. Polyester-lining fabrics have high bending stiffness and polyester/cotton fabrics have high shear stiffness and hysteresis. Other authors also followed the changes of mechanical properties and fabric hand of polyester fabrics through wet processing and the finishing stages (Matsudaira M., Matsui M., 1992). Balci and Gençer investigated the necessity of the cellulase enzyme application for cotton based woven fabrics. They found out that the sequence, before or after dyeing, of application of cellulase enzyme treatment especially affected the handle properties (Balci O., Gençer U., 2013). Geršak investigation was aimed to clarify the influence of fabric mechanical behavior on form changes, as well as on the impact of particular fabric mechanical properties on garment appearance quality (Geršak J., 2003). The results indicated high correlation between garment appearance quality and formability elastic potential and draping.



Tsucada et al. shown that the changes in tensile, shearing, bending and compression behavior of grafted wool fabrics are due to the reduction of the free internal volumes of the fabrics, leading to a tightening of its texture (Tsucada M. et al., 2013).

The aim of this paper is to investigate the ability to affect the total hand value and sewability of stylish clothing through the fabric structure variation.

## EXPERIMENTAL PART

The total hand value and sewability of 100% wool and lycra wool has been studied. Three pairs of fabrics were processed. The fabrics in each pair differ only in one parameter of the structure. Namely, every other pair of fabrics is obtained with a small variation in relation to the first fabric.

The variation of the fabric structure in the first pair was performed through a change in the weft density of the yarn. Namely, the first fabric in the pair A1 has a lower weft yarn density, while the second fabric A2 has a higher weft yarn density. All other fabric parameters are the same.

At the second pair of fabrics, the variation is performed versus weft yarn count. The first fabric in the pair B1 has a single ply weft yarn of lower count, while fabric B2 has a double ply weft yarn of higher count. At the third pair of fabrics, the structure variation is the same as in the first pair, i.e. the change in weft yarn density. Thus, fabric C1 has a lower weft yarn density, while the other fabric C2 has a higher weft yarn density. The first and third pairs of fabrics are different in finishing so that the first pair of fabrics has a standard finishing and the third pair has milled finishing. The characteristics of the structure of the tested fabrics are given in Table 1.

*Table 1: Parameters of fabric structure*

Fabric	A1	A2	B1	B2	C1	C2
Fiber composition	98% wool 2% lycra		100% wool		100% wool	
Yarn count, warp, tex	17x2	17x2	15x2	15x2	17x2	17x2
Yarn count, weft, tex	17x2	17x2	24	15x2	17x2	17x2
Warp density, cm <sup>-1</sup>	32	32	31.2	31.2	30.8	30.8
Weft density, cm <sup>-1</sup>	24.80	26.2	27.6	28	25.6	28.2
Fabric thickness, mm	0.36	0.41	0.29	0.34	0.39	0.41
Fabric weight, g/m <sup>2</sup>	213	227	167	187	213	227

The fabrics were tested on KES-FB's objective evaluation system, which consists of four instruments: KES-FB1 - Tensile and Shear Tester, KES-FB2 - Bending Tester, KES-FB3 - Compression Tester and KES-FB4 Surface Tester. Based on the mechanical characteristics of the fabric, total hand value (THV) and control card sewability were obtained.

## RESULTS AND DISCUSSION

### Effect of fabric characteristics on Total Hand Value

Primary and total hand value - THV of first pair investigated fabrics for men's winter and summer suit are given in Table 2.

*Table 2: Total hand value of A1 and A2 fabric for first pair*

Men's Winter-suit fabrics			Men's Summer-suit fabrics		
Primary hand	A1	A2	Primary hand	A1	A2
KOSHI	5.35	5.25	KOSHI	5.23	5.12
NUMERI	5.41	5.22	SHARI	3.70	3.61
FUKURAMI	4.01	3.97	HARI	5.17	5.47
			FUKURAMI	5.72	5.68
<b>THV</b>	<b>3.24</b>	<b>3.14</b>	<b>THV</b>	<b>2.93</b>	<b>2.92</b>

Regarding the hand properties for winter suits, there is no greater difference between the two fabrics. Fabric A1 has a higher THV 3.24 while fabric A2 has a lower value of 3.14. For both primary values of stiffness (Koshi) and fullness and softness (Fukurami) fabrics have similar values. The fabrics show slightly greater value of smoothness (Numeri): a fabric with a smaller weft yarn density of 5.41 and a fabric with a higher weft yarn density of 5.22. The difference in the Numeri contributes to the difference in the THV, which is why the fabric with larger Numeri also has a higher total hand value. The high value for smoothness is a result of a lower mean deviation of coefficient of friction (MMD) for fabric A1 (lower weft yarn density) compared to fabric A2 (higher weft yarn density).

Regarding hand properties for summer suits, total hand value for fabric A1 is 2.93 and for A2 is 2.92 (Table 2). According to this, this pair of fabrics is more suitable for winter clothing. The lower value of crispness (Shari) contributes most to the lower total hand value of fabrics for summer clothing.

Primary and total hand value - THV of second pair investigated fabrics for men's winter and summer suit are given in Table 3.

*Table 3: Total hand value of B1 and B2 fabric for second pair*

Men's Winter-suit fabrics			Men's Summer-suit fabrics		
Primary hand	B1	B2	Primary hand	B1	B2
KOSHI	4.73	5.92	KOSHI	4.01	5.38
NUMERI	3.98	3.45	SHARI	4.58	5.35
FUKURAMI	2.09	1.87	HARI	4.27	4.22
			FUKURAMI	4.96	6.55
<b>THV</b>	<b>2.02</b>	<b>1.92</b>	<b>THV</b>	<b>3.25</b>	<b>3.31</b>

Regarding hand properties for winter suits, there is difference between B1 and B2 fabric. As a result of higher weft count, B2 fabric has lower THV of 1.92, compared to B1 (2.02). This is a result of differences in primary hand values of (Numeri) and fullness (Fukurami). Fabric B2 has low Numeri (3.45) and Fukurami (1.87), opposite to fabric B1 that has higher values of Numeri (3.98) and Fukurami (2.09). Smoothness and Fullness of the fabric has great influence to total hand. Otherwise, higher value for (Fukurami) fullness is a result of higher work of compression for B1 fabric compared to B2 fabric. Higher value for smoothness is a result of lower geometrical roughness (SMD) for B1 fabric compared to B2 fabric. The total hand value for both fabrics is about 2, which means that this pair of fabrics is not recommended for winter clothing.

Regarding hand properties for summer suits, there is great difference between B1 and B2 fabric in primary hand of Koshi (stiffness) and Fukurami (fullness and softness) of the fabric. The high value of Koshi and Fukurami results in somewhat higher THV of 3.31 for B2 fabric. Results favour B1 and B2 fabric for being much better choice for summer suit. So, increasing of weft yarn count, results in higher THV for summer suit garment.

Primary and total hand value - THV of third pair investigated fabrics for men's winter and summer suit are given in Table 4.

*Table 4: Total hand value of C1 and C2 fabric for third pair*

Men's Winter-suit fabrics			Men's Summer-suit fabrics		
Primary hand	C1	C2	Primary hand	C1	C2
KOSHI	4.80	5.36	KOSHI	4.68	5.05
NUMERI	5.53	5.21	SHARI	4.27	3.65
FUKURAMI	4.43	4.29	HARI	5.56	5.34
			FUKURAMI	5.81	6.12
<b>THV</b>	<b>3.30</b>	<b>3.22</b>	<b>THV</b>	<b>3.22</b>	<b>2.86</b>

Regarding the hand properties for winter suits, there is a greater difference in the primary hand for Koshi: fabric C1 has a lower value (4.80) than C2 (5.36). The higher value of Koshi results in an increase in bending rigidity (B) and shear stiffness (G) in fabric C2.

At the primary hand Numeri, the fabric C1 has a higher value (5.53) than C2 (5.21). The larger Numeri on fabric C1 results in less rigidity of this fabric and a smaller mean deviation of coefficient of friction, and also lower shear and bending stiffness. The higher compressive energy value on fabric C1 also contributes to a lesser degree of smoothness of fabric. For the primary hand Fukurami both fabrics have approximate value. Results favour this pair of fabric as much better choice for winter suits.

Regarding hand properties for summer suits, there is great difference between the primary hands of Shari i.e. crispness of the fabrics compared to other primary hands what affect that this pair of fabrics has lower value for summer clothing. It can be concluded that increasing weft yarn density results in reduction of the primary hand Shari from 4.27 to 3.65, (Table 4).

### **Effect of fabric characteristics on tailorability**

In designing the control charts of garment manufacturing processes, seven parameters are used from the ranges of straining and shearing properties on the fabric under a low load. In designing the control charts of garment manufacturing processes, seven parameters are used from the ranges of strain properties and shearing on the fabric under a low stress. The goal is to define two zones associated with each of the mechanical properties: the controlled zone and the non-control zone. When the mechanical properties of the fabric material relevant to the process of tailorability fall into a non-control zone, this means that no extra control is required of the process of tailorability. Conversely, if a mechanical property value falls outside the non-control zone, this means that special instructions and additional activities are required to process high quality clothing.

Figure 1 represents tailorability charts for investigated fabrics A1 and A2 for first pair.

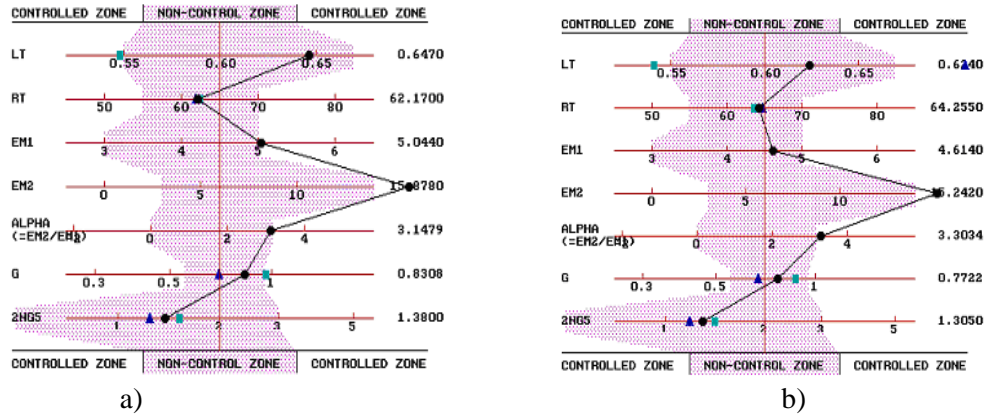

Figure 1: Tailorability chart for fabric A1 a) and fabric A2 b)

From the control charts (Figure 1) it can be seen that the mechanical characteristics of both fabrics are mostly located in a controlled zone where there is no need to control the process of tailorability. Only in the case of the higher weft yarn density (A2),  $\alpha$  parameter is in the zone where additional control is required. This parameter has a higher value in fabric A2 as a result of weft tensile extensibility reduction, but also a reduced tensile extensibility by warp so that a higher ratio of  $\alpha = EM_1 / EM_2$  is achieved. For fabrics with a high value of this parameter, problems with sewing and steam-press operations may be expected. Also, in fabric A1 the parameter  $EM_1$  or tensile by warp is slightly outside of the non-control zone and has a value greater than 5%.

Therefore, in these fabrics, problems can be expected in the cutting process. Otherwise, at both fabrics, tensile by weft comes outside of a non-control zone. Greater tensile by weft suggests that these garments will have good wearing comfort, but the greater attention should be paid to the number of layers on the fabric in the cutting operation, as well as in the sewing and steam-press operations due to possibility of distortion. It can be concluded that the variation by weft density at A2 fabric in pairs has affected the reduction of its processability.

Figure 2 represents tailorability charts for investigated fabrics B1 and B2 for second pair.

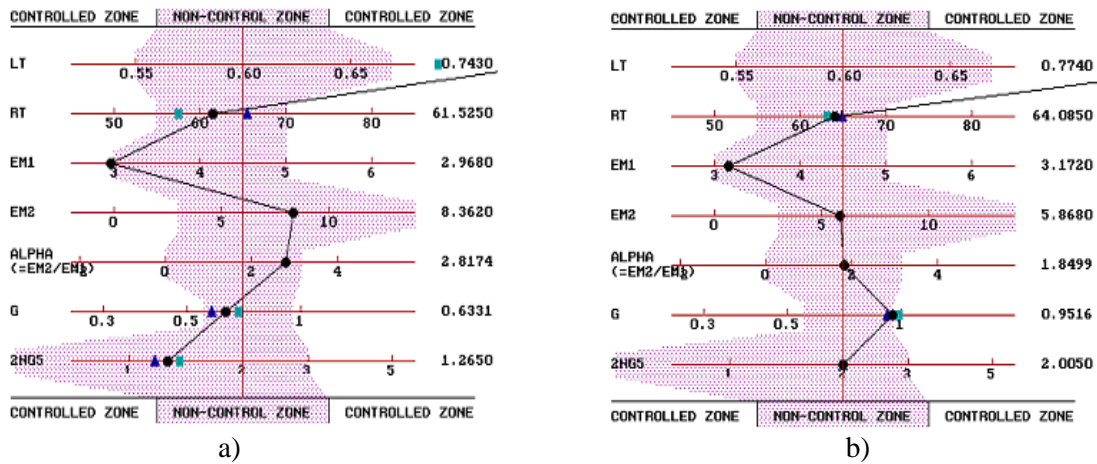

Figure 2: Tailorability chart for fabric B1 a) and fabric B2 b)

For both fabrics, the linearity of the load-extension curve (LT) falls outside the non-control zone. This is particularly true for fabric type B2 (double weft yarn count) which has a higher value of LT (0.774) than fabric B1. The value of the parameter is greater than 0.7, which means that problems with sewing with overfeed are expected in these fabrics. For fabric B1, the EM<sub>1</sub> parameter (extensibility, strain at 500 gf / cm of tensile load) has a slightly lower value of 3% and falls outside the non-control zone, which again points to sewing problems with overfeed. For fabric B2 as a result of the introduction of double weft yarn count, the shearing stiffness increases, so parameter G is slightly out of the non-control zone and indicated possible problem in sewing operations with overfeed, (Figure 2).

Generally introduction of higher weft yarn count should contribute to better summer value clothing, but there are greater sewing problem that should be prevented to obtain high quality garment. Figure 3 represents tailorability charts for investigated fabrics C1 and C2 for third pair.

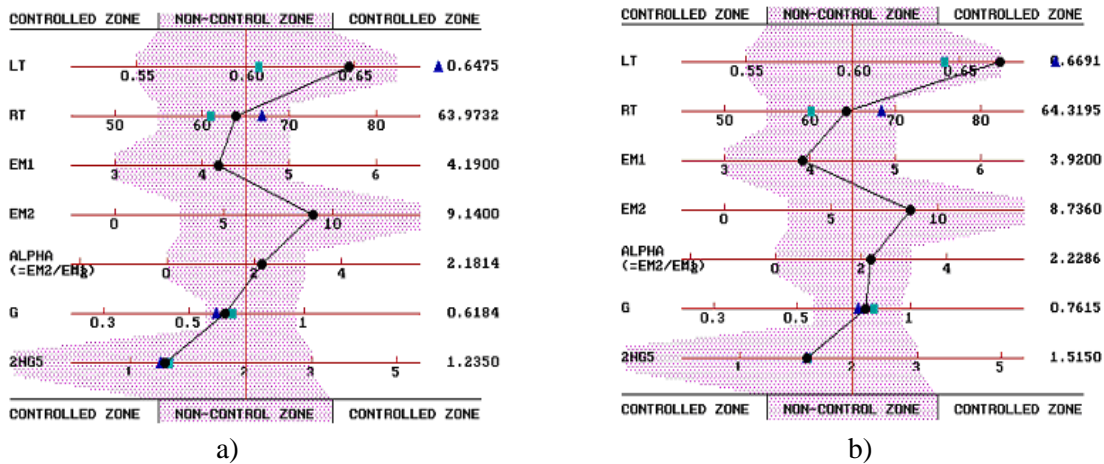

Figure 3: Tailorability chart for fabric C1 a) and fabric C2 b)

In the third pair fabrics, all mechanical properties are in a non-controlled zone. This means that the tailorability of these fabrics does not expect problems. For fabric C2, the value of the LT parameter lies at the limit of the non-controlled zone (0.6691) and the limit is 0.7. When fabrics have a higher value of 0.7 to predict problems with overfeed operations, (Figure 3).

If we compare this pair with the first pair of studded fabrics it can be seen that both pairs have different fiber compositions, which suggests that the first pair with lycra have greater potential problems in the tailorability process compared to the third pair that is 100% wool.

## CONCLUSION

Comparison of the primary and total hand values of fabrics of the first pair suggest that the increase in weft yarn density influence the primary hand of fabric, with the most pronounced effect having over the primary hand value of Numeri if the fabric is graded as winter clothing.

Comparison of the total hand value for fabrics of second pair B1 and B2 for winter (2.02 and 1.92) and for summer clothing (3.25 and 3.31) shows that fabrics has a better total hand if selected for summer clothing.

The third pair and the first pair of fabrics, which have the same weft and warp yarn count, but vary in fiber composition and finishing show that the third pair (C1/C2) has a higher primary value and total hand value. This is a result of milled finishing in the third pair which contributes to better total hand for winter clothing.

Increasing weft density in the first pair of fabrics A1/A2 has contributed to increasing  $\alpha$  parameter and it's moving outside of non-control zone rising possible problems in sewing operations and steam-press operations.

By introducing the double ply weft yarn count in the second pair has influenced the higher values of LT parameters and G parameters, which increases the probability of problems in overfeed operations.

## REFERENCES

- [1] Kawabata S., Niva M. (1999). A guideline for manufacturing "ideal fabrics", *International Journal of Clothing Science and Technology*, 11(2/3), 134-140.
- [2] Kawabata S., Ito K., Niwa M. (1992). Tailoring Process Control, *Journal of the Textile Institute*, 83(3), 361-374.
- [3] Ly N.G., Tester D.H., Buckenham P. (1991). Simple Instruments for Quality Control by Finishers and Tailors, *Textile Research Journal*, 61(7), 402-406.
- [4] Cheng K.P.S., How Y.L., Yick K.L. (1996). The Application of Fabric Objective, Measurement in Shirt Manufacture, *International Journal of Clothing Science and Technology*, 8(4), 44-64.
- [5] Vassilidais S., Venetsanos D.T., Provatidis C.G. (2005). Optimization Aspects on the Hand of the Fabrics, *Textile Research Journal*, 75(9), 653-661.
- [6] Leung M.Z., Lo T.Y., Dhingra D.C., Yeung K.W. (2002). Relation between Fabric Formability, Bias Extension and Shear Behavior of Outerwear Materials, *Research Journal of Textile and Apparel*, 6(1), 39-52.
- [7] Postle R., Mahar T. J. (1982). Basic Requirements for an International Objective Measurements Programme for Wool Fabric Quality, *Textile Machinery Society of Japan*, Osaka, Japan, 1-22.
- [8] Postle R., Kawabata S., Niwa M. (1983). Objective Evaluation of Apparel Fabrics, *Textile Machinery Society of Japan*, Osaka, Japan.
- [9] Gong R. H., Mukhopadhyay S. K. (1993). Fabric objective measurement: a comparative study of fabric characteristics, *Journal of the Textile Institute*, 84(2), 192-198.
- [10] Matsudaira M., Matsui M. (1992). Changes in the mechanical properties and fabric handle of polyester-fiber through the finishing stages, *Journal of the Textile Institute*, 83(1), 144-155.
- [11] Balci O., Gençer U. (2013). Cellulase enzyme application for the cotton based woven fabrics, Part II: The determining of necessity and cellulase enzyme application sequence in the finishing process, *Industria Textila*, 64(2), 80-88.
- [12] Geršak J. (2003). Investigation of the impact of fabric mechanical properties on garment appearance, *Tekstil*, 52(8), 368-379.
- [13] Tsukada M., Khan M. M. R., Miura T., Postle R., Sakaguchi A. (2013). Mechanical performance of wool fabrics grafted with methacrylamide and 2-hydroxyethyl methacrylate by the Kawabata Evaluation System for Fabric method, *Textile Research Journal*, 83(12), 1242-1250.

## TEAMWORKING ON A FASHION COLLECTION INSPIRED BY THE SERBIAN CULTURE IN HUNGARY

**Nenad Stojanovic, M. Pavlovic, D. Joksimovic, A. Milosavljevic, V. Petrovic**

\*Yumco Munchen, Germany

\*Tehnički fakultet "Mihajlo Pupin", Zrenjanin, - Đure Đakovića bb, 23000 Zrenjanin

\*Faculty of Technology Leskovac, University of Nis - The scholarship holder of the  
Ministry

e-mail: [marica.pavlovic4@gmail.com](mailto:marica.pavlovic4@gmail.com)

### ABSTRACT

*As project work assignment we were supposed to create fashion collection for Spring/Summer 2018. that is inspired with culture heritage and traditional costume od Serbs who immigrated in past centuries to Hapsburg Monarchy, today Hungary and stayed to live here generations after.*

*Beginning of the brainstorming for collection was the vibe we wanted to give as well as who do we create for, who and what is "that woman" like, how do we want her to feel in our clothes, and what impression we want her to give to others. The words we had in mind as impression we wanted collection to give were bold, strong, powerful, smart, fresh, statement, bright, stripes...*

*KeyWords: fashion, Serbian culture, Hungary, teamworking,...*

### 1. INTRODUCTION

In our work, we will represent phases, tools, methods and final products made in joint teamwork. We will introduce our platform made the collective work easier. The entire phases of the development process: target and implements of the research process, the criteriums of the requirements, the inspirations and the process of framing the design concept, and the process of development of the ready samples. Also, in this work we will present process of creating our collection inspired by culture and heritage of Serbians in Hungary combined with trends for Spring/Summer 2018. We'll introduce team members and their part of participation in the project and the phases we have passed through in order to get the quality final product, modern woman collection. In the end, we will present complete outfits made from our collection and the process of making them from idea to realization and finishing styling them for photo shooting.

Clothing takes a special place in the cultural heritage of human society and represents the seal of a time, the course of cultural development and the way of life in each period of time from the creation of the first garment to this day. We all need clothes, and that is one of the most elemental needs of human society, as a condition for the protection and survival of the human species.

The first traces of the existence of clothing originate from the early Stone Age, with these clothes made of animal leather and fur. Since the animal skin was not elastic enough, it could not even cover all parts of the body evenly, without affecting the mobility of people, so the need for designing clothes appeared. Over time, people have found a way to soften and cut off the skin to various desired shapes and parts. All this contributed to one of the greatest inventions in the history of mankind - a sewing needle with a hole and the appearance of sewing operations as a way of composing cutted shapes of skin for covering the body. This type of garment production has lasted for many centuries to date and represents a crafty way of garment production. This method of garment production involves the production of clothing items according to individual customer measures and productivity is low. With the advent of industrial revolution and the invention of sewing machines, industrial clothing production also took place.

By further development of production technology, the division of work into a large number of technological operations was developed, with increased product quality and productivity. The serial production of clothing significantly reduced the prices of clothing. Since then, clothing is mainly intended for a wide market.

Using pneumatic and electromechanical devices, modern sewing machines were created, and with the use of electronic components, the devices were combined into sewing aggregates.

The emergence of microprocessors has enabled even greater efficiency of the technological process of garment production by connecting different production systems to computer networks. And the IT revolution itself has contributed to the phenomenon of the global village, because every novelty in the field of fashion industry has emerged in any part of the world able to go around the whole planet within a few hours.

Today, dressing is not just covering and protecting the body. It can be said that the dressing is a form of communication. Sometimes unconscious, we show our attitude, character, mood, profession, social status, status or all at once. Clothes hide our body and at the same time reveals us much more than we are aware of, even people who "do not pay attention to their own way of dressing" -show that with their clothes. Clothing today has absolutely its protective, aesthetic, social and economic function.

## **2. RESEARCH ON LATEST FASHION TRENDS AND CULTURAL HERITAGE OF SERBS INHABITED IN HUNGARY**

Basic feature of our project was to make a research on the latest Spring/Summer 2018. fashion and commercial trends to maintain the currency of the collection. Special feature of our project was to make a research on the Serbian folk art, which is very rich and has a unique treasure of motifs, colours, shapes and techniques.

Part of the task was to make a research work in the Serbian Cultural Centre, and to visit Szentendre, and the villages around it, where to experience ourselves in the peasant life of the Serbs (re)located in Hungary.

This experiences inspired us very much. We we've been inspired for to design a collection, inspired by the extraordinary, local Serbian heritage integrating the traditions of our nation in the collection. We decided to apply the shapes, motifs, and techniques on our own opinion, on a professional way.



*Figure 1. Serbian folk art (costume)*

### **2.1. Life and culture of Serbs inhabited in Hungary**

After the one hundred fifty-year-old Turkish authorities, Hungary was freed from the Ottoman Kingdom at the end of the 17th century. The population was faced with the difficult times of the foreign rule and in the turbulent events of the liberation wars, and many of the foreigners settled in Hungary.



In particular, the Germans came in large numbers, primarily in the cities. So Pest and Buda at first received more or less German marks.

More than half of the population in Pest was German until 1850 and probably the same for Buda. And some facts from cultural life indicate the situation: in the press of the University of Pest, which was then located in Buda, it was printed between 1778 and 1803. 295 German, 192 Hungarian and 118 Serbian publications; from 1804 to 1824 257 German, 236 Hungarian editions and 241 publications in Serbian; between 1825 and 1849 372 German editions, 951 Hungarian and 312 publications in Serbian. Therefore, only in the second quarter of the last century Hungarian editions were dominant. Another example: in 1812 a permanent German theatre was established in Pest, while the Hungarian National Theatre was only in 1837 opened their doors.

Flags from historical Serbian books also inspired us, to make some print designs.



*Figure 2. Historical illustration, artistic header from one of the Serbian books in Hungary*

In the schools, at the university, in the editions of newspapers and magazines, in the noble and civil circles, the Hungarian spirit expanded. The visible results of this development were: the founding of the Hungarian Academy of Sciences (1825) and the National Theatre (1837).

After the liberation of Hungary from the Turks, there were also groups of other nations beside the Germans. At that time, many Serbs and Croats came to the country. Serbs were here already during Turkish rule, but their number increased significantly in the "big break" of 1690 when 40000 families found their new homeland in the Pannonian region. Further migration occurred during the first half of the 18th century: "From the Austrian wars with Turkey at the end of the seventeenth century and in the first half of the 18th century, the Serbs' moving in southern Hungary and the awakening of a new Serbian educational life came out, because this way of our tribe was brought into the bond with a European movement" - writes our well known historian, Stojan Novaković<sup>1</sup>. The number of Serbs in Pest and Buda increased by settling after the 1 Stojan Novaković<sup>1</sup> (1842-1915), a well-known historian and literary historian, a professor at the Grand School and a minister in several Serbian governments. Very convenient places, where Serbs could enter a close connection with Western, or Central European culture, were two Hungarian towns on the banks of the Danube: Pest and Buda.

Liberation of Hungary from the Turkish authorities. Here at that time, the opportunities for material and cultural development were more favourable than in the motherland, where successful fighting for the liberation from the Turkish Kingdom began 120 years later and where these struggles lasted longer. In this strange environment, the Serbs lived their lives, mainly within the framework of Serbian Orthodox municipalities. This is primarily true for the Budan suburb of Taban, where the civilian authorities were in their hands, where, on the basis of the privileges obtained from Vienna, they had their own "dungeon", their officers, bureaus and "eccentric". Serbs in Pest were enjoyed some privileges.

The Serb population raised themselves Serbian schools in Budim and in Pest. The Serbian church municipality in Budim, for example, 1746 school regulations that fit the spirit of the then pedagogical principles. In the 18th century, it was in the Budim's Serbian school - we have data for 1730, 1734 and 1770. - about 60 students. This number was subsequently reduced, according to one data from 1822, there were then only 40 pupils. From the end of the 17th century, in Pest, a Serbian school was operating, which according to the data from 1770 and 1827, was attended by about 30 pupils.

In 1808, Pestan Serb school was expanded to the third grade, and since "cookbooks" and "choreographers" were taught here also by "orthographers" who already had a lecture in the Latin language.

Of the few Serbian teachers in Pest, the most famous and most important, associate Vuka Stefanovic Karadzic, Luka Milovanov who has his indisputable merits in composing the first Serbian grammar, Vuk's Literature of the Serbian Language (1814).

Living in a nice number, in favourable economic conditions in Pest and Buda, the Serbs also developed their social life here. Buda was probably the largest Serbian settlement in the 18th century, so that we can read it with Milorad Pavic, but we do not know much about the cultural life of Serbs in Buda. According to some data, we can conclude that a vivid cultural activity has developed here. For example, in Buda lived Jovan Damjanovic, who was around 1728. He was on a pilgrimage to Jerusalem and wrote a travelogue with many autobiographical elements about this unusual event of his life. In Buda, in 1776, born by the famous painter Mihajlo Zivkovic. He studied at the Academy of Fine Arts in Vienna and after finishing his painting studies he settled in his hometown, where he had his own painting workshop. Soon after returning home, Zivkovic painted Slavic icons for Serbian citizens in Buda, Pest and Szentendre. .

The Serbs were otherwise in Pest and Buda as at home, as Dinko Davidov said in one place: "... while in Pest and Buda they always felt like at home, raised their churches, published newspapers and books, founded In the 18th century and the beginning of the 19th century, the Serbs who lived in Hungary considered this country their homeland. Returning from Russia, Sava Tekelija wrote, for example, this: "I was glad at the market that I had come to my country, there would be white bread in the market, that bacon, here cakes, and so forth, and thought: blessed is my land!"



*Figure 3. Hungarian coustime*

In Pest and Buda, where Serbs have lived in their established lives since the 18th century, they have been fighting - as we have already seen - aware of the youth of several nations to raise their literature, to develop their culture, and thus to raise and consolidate national consciousness. Here was a favourable atmosphere for cultural and national work, and the Serbs were self-aware of these possibilities. There were people dedicated to Serbian teachers and priests, lawyers and a lot of students. At the end of the 18th century, students of the University of Pest were: the great Serbian benefactor Sava Tekelija (1761-1842); prominent writer of Serbian enlightenment Jovan Mušatirović (1743-1809); writer, poet and translator, and Professor of the University of Russia Grigorije Trlajić (1766-1811) and the most important poet of Serbian classicism, "Serbian Horace" Lukijan Mušicki (1777-1837). Later they studied at Pest: Sava Mrkalj (1783-1833), and a reformer of the Serbian alphabet, one of the most important forerunners of Vuka St. Karadžića; Jovan 2? M'c (1786-1845), poet, writer of pedagogical works, educational worker; "Serb Ilir from Backa" Petar Jovanovic (1800-1855), editor of the Backa villa (the only Serbian periodicals that propogated the ideas of anise); Dimitrije Davidović (1789-1838), founder of the Novel of the Serbian, the first Serbian daily newspaper, which from 1813 to 1821, he went to Vienna (in 1816, for example, he had most subscribers in Pest, 16 of them , while there were only 5 of them in Serbia); Georgija Magarašević (1793-1830), the initiator and first editor of the Letopis; Mihailo Vitković (1778-1829), a bilingual poet and writer; Jovan Sterija Popovic (1806-1856), one of the most prominent Serbian writers of the last century, is the most important comedian of his time whose pieces still remain on the repertoire of Serbian theaters;

Jovan Stejić (1803-1853), a doctor and writer, "one of the main Hungarian Serbs who entered the" more educated "in Serbia (Skerlic); Jovan Hadžić-Svetić (1799-1869), prominent poet of Serbian classicism, one of the founders of Matica Srpska and its first president, the creator of basic laws in Serbia; Jovan Subotić (1817-1886), poet, playwright and editor of Letopis and others.

In the first half of the last century - when Pest and Budim played an important role in the Serbian cultural life - many prominent Serbs lived in, or lived in the fraternal cities on the Danube coast.

The most important cultural and historical event of the Serbs, which connects to Pest and for the time being discussed, is certainly the founding of the Matica Srpska in 1826.

After the end of the Viennese Newspaper of the Serbs in 1822, the Serbs did not have a single newspaper or a magazine. Literary life, however, began to evolve, as there was growing Serbian intelligence. Novi Sad's professor Georgije Magarašević satisfied the needs of his compatriots when he was 1825. Launch Letopis. He edited a newspaper in Novi Sad, which, of course, was printed in the Budim University Press, and the publisher was Konstantin Kaulicius. The program of the journal is given in the foreword of the first volume. His Slavic character can also be seen from a brief quote: "Everything that the Slavic people from the Adriatic to the Ice, and from the Baltic to the Black Sea, are in common, especially when we are being spammed in literary prizrenija, all of which are the subject of Serbian Letopis. "The first name of the journal was the Serbska Letopis and only in the third volume it was given the title of the Serbian Letopis.

Matica's work became more and more important in the cultural life of the Serbs. Particularly important were her competition for rewarding fiction. The first prize was awarded in 1839. During the Pestan period, until 1864, seven writers were awarded, among them Jovan Subotić, Đura Jakšić and Laza Kostić. Over time, Vuk's reform of literary language and spelling has penetrated into Matica and has finally won. Matica srpska managed to - after trampling with the authorities - in 1864, moved to Novi Sad, where he still publishes Letopis and various scientific journals and other publications. It is very successful in her modern, diverse cultural, scientific and literary mission.

The engagement of Serbian merchants in Pest and Budim had a positive reputation beyond the Serbian world. Recognizing the great importance of Matica's cultural and national activities in the life of Serbs, similar societies are established their Maticas, for example Slovenian peoples in Austria, even borrowing their name. Thus, Matica Ilirska (later Matica Croatia), Matica dalmatinska, Matica slovenska, Matica czechka, Matica slovačka were formed.

## **2.2. Establishment of Tekelijanum**

Sava Tekelija was born in 1838 founded a student dormitory for Serbian students of the Pestan University, where poor pupils with the best grades were received. In this boardroom, twelve students had a free apartment and annually one hundred forints for support. From that time, it is possible for poor Serbian young men to studz. Without this charity, they would probably never be able to get that kind of education in their time. Through this institute, more than 400 peoples had passed through the First World War, which made up a large part of Serbian intelligence in the former Hungary. Many of them moved to Serbia after studying to put the knowledge gained at the Hungarian university, the spirit and mood of the Serbian student dormitory in Pest, serving their people in the motherland, for example, Jovan Djordjevic (1826-1900), founder of the Serbian National Theatre in Novi Sad (1861) and the Belgrade National Theatre (1868), and later professor at the Great School in the Serbian capital. In 1892, Djordjevic was a minister of education in the Serbian government for some time. The Institute of Serbian Students in Pest, the first student dormitory in the Serbs in general, was named after its founder, "Tekelijanum".

In the house, which was bought for Tekelijanum, Matica srpska was located, which from 1838 to 1878 managed the institution. (After the administration was handed over to the Serbian Orthodox Church in Pest.) Thus, in today's Veress Pálne Street, the home became a Serbian cultural and political centre.

Every year, there were celebrations in the world, and here in 1838, the first Serbian concert was organized, of course, during a farewell, when many Serbs from abroad stayed in Pest.

The former Pest and the former Buda, today's Budapest - as the place of the first Serbian public theatre show, and the printing houses where about 600 Serbian publications were printed in the first half of the last century, then as the seat of Matica srpska for some four decades, then as a fishing village with its once famous earthly fairs where Serbian books, magazines, calendars were sold in large numbers and where Serbs from all over were finally occupied and ultimately a university town where many Serbs studied - has a certain, unusual role, its significance in the Serbian cultural and literary history.

### 2.3. Result of Historical research

The pictures below show the costumes of the Serbs who settled in Hungary. The features of traditional Serbian costumes from the Vojvodina are noted on them, but there is also a significant influence of Hungarian costumes and culture.



Figure 4. Serbian costumes owned by KUP "Opanke" from Pomaz

### 2.4. Result of colour trend research

The Spring-summer 2018 palette encourages a sense of fun and playful release. With an air of complexity and distinctiveness, we find ourselves in a sanctuary of color that is ideal for some more unique and dramatic color mixing.



Figure 5. Pantone colour palette for Spring/Summer 2018.

### 2.5. Result of trend research

If there's one thing worth spending some money on, it's a perfectly tailored suit. These days you can find the style to match your personal taste because the concept is a now constant fixture on the runways. Whether you want to make a statement (Chloé's horse-motif velvet suit is going to be a street style hit—mark our words) or opt for something subtler, there are 1001 versions out there. In a move that felt comforting and easy to style, we saw a lot of monochrome looks as part of the spring/ summer 2018 fashion trends.

Many of these looks were layered, like the jackets, button-up shirts, and flared pants at Victoria Beckham in white on white, pink on pink, and lavender on lavender. At Michael Kors, this trend was featured in pinks and blues, with a lot of flowy skirts and dresses and loose trenches perfect for protecting from summer night winds.



*Figure 6. Some of the trendy fashion suits*

Should the past few years of leggings and track pants have destroyed your old-fashioned fashion soul, rejoice in the pencil-skirt comeback. This time around, they are longer-lined and therefore more flattering. They will replace your full-skirted midis for the time being but are always worth keeping for the future. Net-a-Porter has predicted this silhouette will be a big seller for them in 2018.

This timeless staple, perfect for the office or for a cocktail party, was an easy fit into the spring/ summer 2018 fashion trends. Pencil skirts can work with any outfit, as we saw on this season's runways.

At the Fendi, Max Mara, and Prada shows, we saw longer pencil skirts, fit for any severe librarian, although a few see-through numbers at Fendi broke that mould. On the No. 21 runway, pencil skirts took on a more casual vibe, thanks to patterned fabrics and lots of tan.

At Gucci, pencil skirts were styled along with oversized sweatshirts, and big hair to go with the collection's '80s vibe. Wide belts that were popular at the end of the 2000s, and which made the waist look pretentious and visual feminine figure into the shape of a sandy clock, are in big style coming back as one of the fashion trends of the spring/summer 2018.

All manners of fabrics were utilized to make high waisted pants – one of our favorite trends, because it's flattering, chic, but also comfortable and perfect for all manner of occasions. In other words, we welcome it as one of the spring/ summer 2018 runway trends. At Roksanda, high waisted pants made of light, warm cotton had a looser fit, and were cinched at the top with a drawstring. This was a romantic, rustic way of styling high waisted pants. The same fit was seen at Isabel Marant, paired with a sharp jacket and a black belt that actually looked very sophisticated and office-ready. There were other beautiful examples of high waisted trousers at Rebecca Taylor, DVF, Tibi, Hermes, and more.



*Figure 7. High waisted pants*

Another of the popular decorative elements of this season was straps, whether in a darker way or simply as a style element. In Michael Kors' bright, summery collection, straps were applied diagonally from shoulder to waist, like a Miss Universe sash. It was unsurprising to see straps figure in the Fenty Puma by Rihanna collection. Strappy bodysuits gave a mix of futurism and edgy kink on that runway.



*Figure 8 Decorative straps*

## **2.6. Trend observations and conclusions**

Our first assignment was to do trend research for spring/summer 2018, we looked for trends on most relevant sources. Trends for this season were really different, they went from pastels to bold rainbow colours. Even though colours, shapes and fabrics were individual, brands that produce clothes for similar types of customer had matching points of view. Our conclusion after fundamental and extensive research (from various relevant sources, mentioed in references) was that trends were variable and diametrically different from one to other fashion centre. The differences were noticeable in colours, shapes, approaches to fabric manipulations and combinations of colours, fabrics etc.

Despite all of this, some of their ideas and suggestions for upcoming spring/summer were similar, so we focused on that.

These points where designers agreed and had same vision were: layering, fabric combinations, transparency, asymmetrical pencil skirts made of unexpected materials, interesting and new forms of necklines, bold colours, ice-cream pastel colours, fringes, ruffles etc.

We compared those trends with our traditional costume research connected all of the information and created our mood boards and designs.

In our further work you will notice all the mentioned elements.

## **3. STABLISHMENT OF THE REQUIREMENTS**

After researches and collecting ideas for a new garment items, fashion designers approach in the process of creation and design of models of garments. Designers in industrial design must adhere to the principles, the principles that products should contain. In our work we respected those principles and these principles are:

-Technical -Esthetic -Economic. Technical principles include the ability to design a model of a garment in operation, taking into account the qualification structure of the expertise of the worker and the specificity of the available sewing machines. The second group of technical requirements refers to the fact that the garment must satisfy the purpose and functionality. The creator must take care of whether he creates a model for working, protective, protective, festive or special clothing.

The economic principle implies the successful placement of products on the market, which can be achieved first if the product has a favorable price.

In order to achieve a favorable price of the product, the costs of production are reduced, and it is extremely important to take into account the maximum consumption of materials.

Aesthetic requirements refer to the outward appearance of products that satisfy the consumer, which implies that the garment has a good cut, color, fabrication and that the appropriate basic and auxiliary material has been applied.

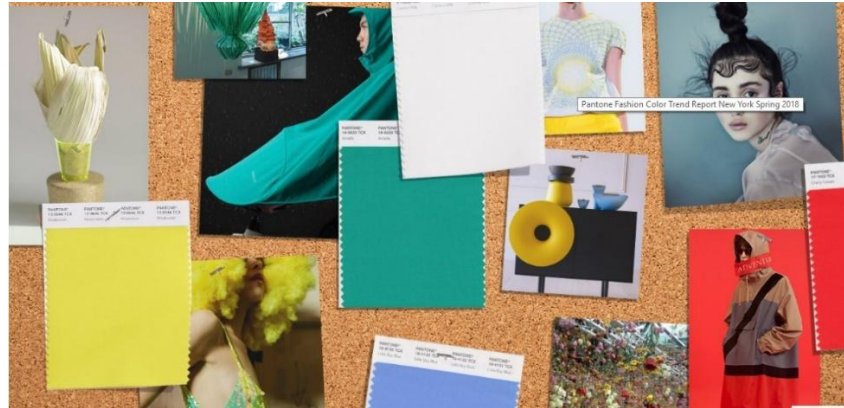

*Figure 9. Decorative papir*

### 3.1 Mood board:



*Figure 10. Mood board*



Figure 11. Mood board

#### 4. PROCESS OF DESIGNING

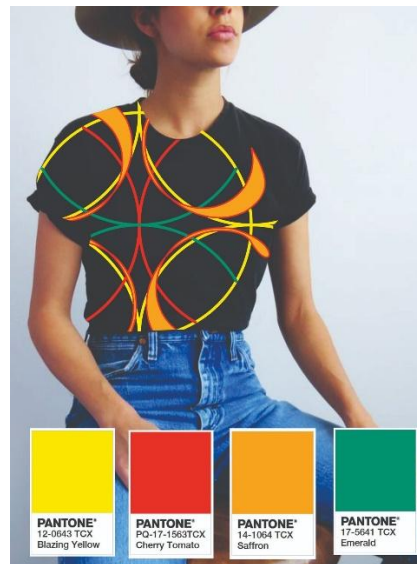
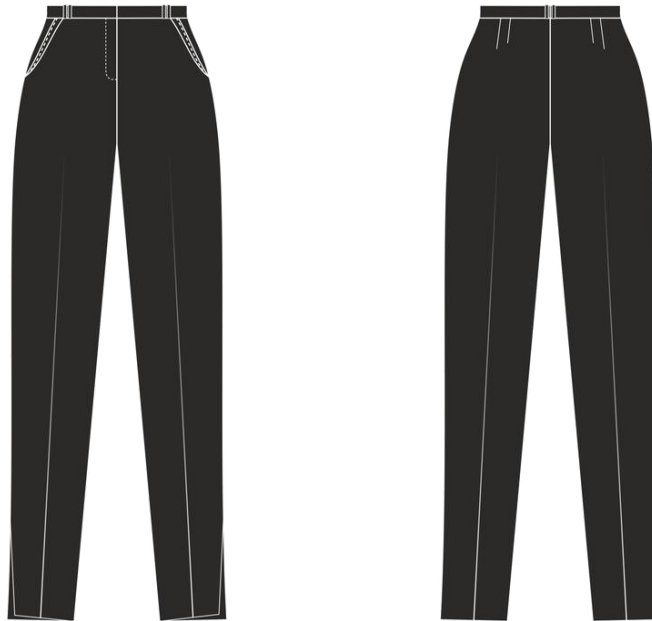

Figure 12. Design T-shirt



#### 4.1 Technical drawing



*Figure 13. Technical drawing of trousers*

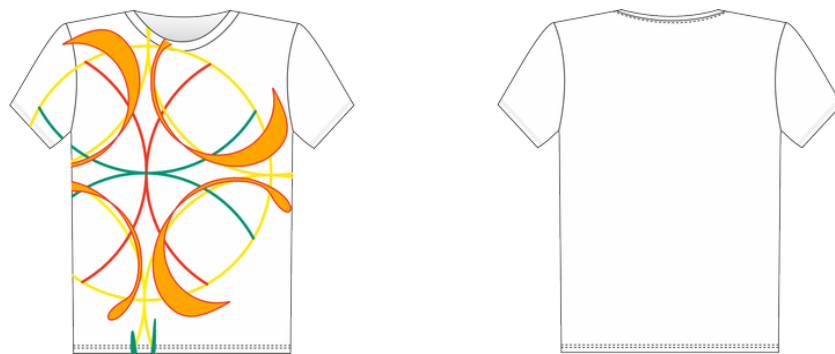

*Figure 14. Technical drawing of T-shirt*

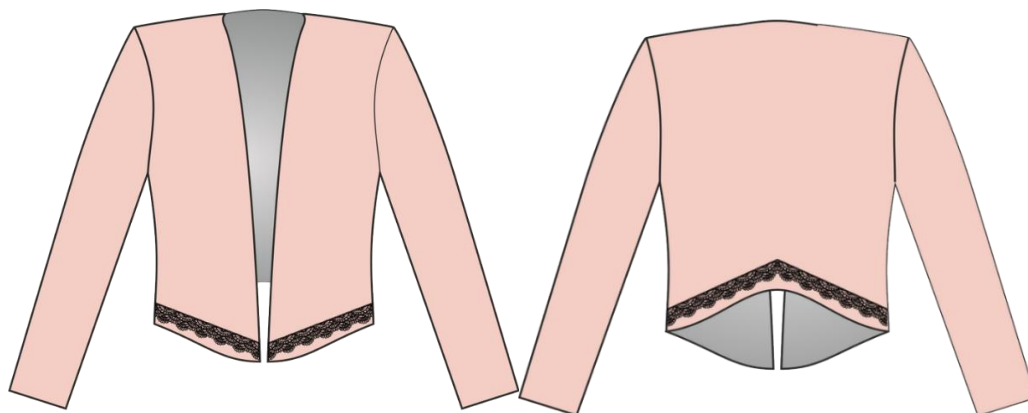

*Figure 15. Technical drawing of blazer*

## 4.2. Final product



*Figure 16. dressed combination*

## 5. CONCLUSION

I did a research of the latest fashion trends for season Spring/Summer 2018, and as a special feature, we made a research on the heritage of Serbian national costumes in Hungary. Combining those two approaches we made a vision of how we want our collection to look like. In this work, authors presented process of creating our collection inspired by culture and heritage of Serbians in Hungary combined with trends for Spring/Summer 2018. We introduced team members and their part of participation in the project and the phases we have passed through in order to get the quality final product, modern woman collection.

In the end, presented complete outfits made from our collection and the process of making them from idea to realization and finishing styling them for photo shooting.

During the process of creating our collection, and later making pieces from it, as well as writing the essay, I learned a lot about ourselves, our teammates and about working in a team. I learned that is not easy to organize 8 people and do everything without heavy discussions.

I worked hard, and tried to be a good team, sometimes it worked, sometimes it didn't. But, the most important is that we managed to finish everything as planned and create outfits out of pieces from our capsules that we like, and that I feel strong about.

On the presentation you will have the honour to see the result of photosession and all fashion photography that we made.

## 6. REFERENCES

- [1] Iz kulturne i književne prošlosti srba u mađarskoj, István Poth 2. <https://www.wgsn.com/en/> 3.
- [2] <https://www.trendstop.com/> 4. <http://www.fashionsnoops.com/> 5.
- [3] <http://www.ubmfashion.com/blogs/springsummer-2018-trend-reports-provided-fashionsnoops> 6.
- [4] <https://www.weconnectfashion.com/> 7. <https://readymag.com/u81963856/799635/13/> 8.
- [5] <https://www.pantone.com/fashion-color-trend-report-new-york-spring-2018>

**Figure:**

Figure 1. Serbian folk art costume, source: Serbian cultural centre, Budapest, Nagymező u. 49, 1065

Figure 2. Historical illustration, artistic header from one of the Serbian books in Hungary,  
<https://www.youtube.com/watch?v=9Au8dS7n5ZA&feature=youtu.be>

Figure 3. . Hungarian costume <http://etno-muzej.com/en/testimonial/vuk-karadzic-citati>

Figure 4. Serbian costumes owned by KUP “Opanke” from Pomaz, source: Serbian cultural centre,  
Budapest, Nagymező u. 49, 1065

Figure 5. . Pantone colour palette for Spring/Summer 2018

<https://www.pantone.com/fashion-color-trend-report-new-york-spring-2018>

Figure 6. Some of the trendy fashion suits

Figure 7. High waisted pants

Figure 8. Pantone colour palette for Spring/Summer 2018.

Figure 9. Decorative paper, <http://www.vogue.co.uk/gallery/spring-summer-2018trends>

## UNIFORMS - WORKWEAR - ERGONOMY

Éva HOTTÓ, Gabriella OROSZLÁNY

Óbuda University

Faculty of Light Industry and Environmental Engineering

Product Design Institute

[hotto.eva@rkk.uni-obuda.hu](mailto:hotto.eva@rkk.uni-obuda.hu); [oroszlany.gabriella@rkk.uni-obuda.hu](mailto:oroszlany.gabriella@rkk.uni-obuda.hu)

### ABSTRACT

*Due to the high quality expectations of today, workwear design is an extraordinarily complex task requiring creative solutions. Numerous factors have to be taken into consideration when constructing proper workwear for a given activity. The customers set higher and higher demands and the role of design of clothing at work also gains importance. Ergonomics that is “the scientific study of the interaction between human and the work environment” has become important in our everyday activities as well. Furthermore, the ergonomic aspects shall always be taken into account at work (Murrel, 1965). The work environment means not only the physical environment surrounding the worker but also all the things, one comes in contact with at work, thus, among other things the workwear which also contributes to safe work. An important requirement that the workwear, their accessories and other add ons – designed with regard to functional, technological, aesthetic and market economy aspects – should be suitable for mass production.*

**Keywords:** *workwear, uniforms, protective clothing, ergonomics, colour functions*

### HISTORICAL BACKGROUND

In medieval times the clothing, the common people used for work, were mostly made at home from natural materials, or they were acquired from barter of used clothes. The clothing of the common people<sup>1</sup> was characterized by kinds of clothes which, in addition to the circumstances of the era, were also influenced by social limits and rules. The use of the worn-out garments as workwear was typical. The workwear, used by merchants, craftsmen, etc., was mainly determined by practicality in relation to their trade. In the 17th century the servants (those belonging to the liveried personnel) were the “best dressed workers”. The yearly contracts, signed with their employers, guaranteed that they could renew their wardrobe. At that time a uniform had great importance as it identified its wearer from afar and showed his social origin. (Flórián, 2001)

The 18th century was the golden age of Hungarian costumes. The braided clothing with dolman and fur lined coat was the basis of the hussars’ uniform. As military uniform, the colours of the individual troops were determined. (F. Dózsa, 2012).

The changeover from production by handicraft manufactories to the mechanized industry started in the second half of the 19th century. With the development of the textile industry ready-made clothes, made of manufactured materials, were available and the appearance of synthetic dyes considerably enriched the colouring of textiles, too. The industrialization, the technical developments and the use of newer and newer materials resulted in the continuous change of the processing technologies.

---

<sup>1</sup> By commoners we mean, in the centuries of feudal bondage until 1848, all strata of those not having noble rank: serfs, peasant farmers, servants, shepherds, citizens of market towns and craftsmen (Flórián, 2001)

The increasing division of labour within the individual professions led to the creation of specialised workplaces and the expedient design of workwear.

The production of ready-made designed quality clothes started in Hungary between the two world wars. After the Second World War the period of more or less uniform clothing followed in the spirit of puritanical work ethic. The design of clothing worn at work reflected simplicity, practicality and the expediency required by the work done. (Kisfaludy, 2005)

In today's fast moving world many old trades, crafts disappear, in turn, newer and newer trades come into being, calling for special requirements concerning the working conditions as well.

## CATEGORIES OF WORKWEAR

Statutory law, legal provisions and decrees define the various workwear as well as the regulations and decrees concerning their wear. According to the character of the working environment three basic types of workwear are distinguished.

### Uniforms

Uniforms the distinctive clothes of different bodies, groups at the workplace or those performing the same activity (Fig. 1). The clothing is obligatorily worn, while performing the work activity, in jobs laid down in regulations.

Typically employers, having national authorization, by virtue of the employer's decision, provide for their employees that their appearance should be uniform and distinctive, thus the identical clothing of the employees refers to the identity of the employer. (Occupational Safety Law)

When designing a uniform, the main aspect is the function and the creation of the unified corporate image. An environmental study shall be made to explore the relationships between the number of the workers, their jobs, materials, colours, cuts and markings. (Kisfaludy, 2005)

Different types of uniforms are:

- **uniforms:** clothing according to standards, worn by professional staff members of certain organizations e.g. Law Enforcement, Police, Fire Brigade, Military of Hungary, Parliamentary Guards, etc.
- **Uniforms at work:**
- uniforms in jobs where the staff is in direct contact with the clients or with those making use of services (e.g. road, water, air traffic, post, telecommunication, bank staff, security guards, etc.)
- service providers (e.g. receptionists, waiters, funeral service providers, etc.)
- uniforms designed for given occasions (e.g. Olympics, special world games - uniforms for sportsmen/women, hostesses, etc.)



*Fig. 1 Uniforms*

### **Simple functional workwear**

The simple functional workwear means clothing designed in accordance with the type of work (Fig. 2) The workwear can be provided by the employer, on the basis legislative regulations. With the use of the workwear the worker protects his/her own clothes against excessive contamination, faster wear and tear. Garments, belonging to this group, are, for instance, work coats, overalls, dungarees, waist pants, breeches, vests, gowns, tunics, collar shirts, T-shirts, pullovers, etc. The workwear provided by the employer has a certain wear time.

After the expiration of the wear time the given garment can remain with the employee. Its cleaning and maintenance is usually the employee's task, it is not mandatory to wear it.

However, the employer may require wearing of the work clothes if, for example, he intends to give unified corporate image to his employees.

In this case usually the firm's logo is put on it.

The workwear is often given to the employees as a kind of social benefit from the employer.



*Fig. 2 Simple functional work clothes*

### **Protective clothing**

Protective clothing is a group of protective equipment serving for protecting the physical integrity of those working in dangerous environment. (Fig. 3) They have to comply with stringent requirements, international standards. They are manufactured with the application of special materials, technological and design solutions.

Protective equipment can only be placed on the market if they have the EC type certificate. The Occupational Safety Law XCIII of 1993 requires in certain jobs the provision of protection against sources of danger. The employer shall provide protective equipment, ensuring their functional usability, protecting capability, proper hygienic condition, necessary cleaning, maintenance, repair and replacement. The employees shall be trained for their use and the latter shall be required.

This group contains e.g. the suits of fire fighters, paramedics, chemical protective suits, clothing products ensuring good visibility, biological protective suits, etc.



*Fig. 3 Protective suits*

## DESIGN AND ERGONOMIC POINT OF VIEW

In the design of workwear the functions, expected from the product, can be realized in knowledge of the field of application, the consumers' demands and the market situation with the simultaneous consideration of the economic and technological possibilities. As the first step of the design process, the type of work, the working conditions and the work environment have to be assessed.

When designing workwear the designer, taking the characteristics of the field of use into account, consciously defines the proportion of the function and the communication. (Becker, Kaucsek, 1998)

Clothing is the closest environment surrounding us thus it basically influences the physiological functioning of our body. The proportions between safety, effectiveness and comfort should be optimized so as to enforce the ergonomic aspects.

They can be enforced in the following areas:

- form design
- selection of the fabric
- choosing the colours and the patterns
- technological and technical solutions,
- selection and application of add ons and accessories.

Often it is very difficult to separate and analyze the listed elements as they jointly give the desired characteristics of the clothing product. Thus a complex relationship can be observed between the listed areas and it is always the field of use of the given working clothes that determines the priority of the above.

### Form design

The external appearance, aesthetic features of clothing products, including workwear, are determined by the form design, that is the location of the cutting lines, and the proportions, widths and solution of details of the clothing overall. All these characteristics reflect the expectations to be satisfied by the product, but – at the same time – they show the stylistic features of the given period too. The workwear does not follow the trends; the form of its basic pieces remains unchanged for a longer time.

From ergonomic point of view the application of properly selected surplus sizes and widths is particularly important. They ensure sufficient freedom of movement but, at the same time, they influence the “venting” and the heat retaining capability of the clothes resulting in better wearing comfort and more favourable physiological characteristics. The most suitable sizes and widths have to be used for a given type of work. With the simple functional workwear and protective clothing usually larger dimensional allowances are necessary to ensure comfortable movement. The uniforms, however, are made with smaller allowances for wearing comfort, similarly to casual garments, which are influenced, in turn, by the prevailing fashion.

Most of the workwear are usually made in ready to wear sizes but, in the case of public orders, a few percents of them are made to measure. The clothing industry cannot make use of the anthropometric size charts that are used in numberless fields of engineering design, in which the average male and female body sizes of a country are given. Certain body dimensions, however, give information of defining the minimum dimensional surplus of the wearing comfort of the clothes. For example, the circumference of the knees measured in standing and bent positions.

When designing workwear it is also important to consider that these clothes will be worn by diverse physiques. Such form solutions, lengths, cutting lines collar –and sleeve solutions, etc. have to be used which can be preferably suited to various types of bodies.

The form of the work –and protective clothes and their solution of details are determined first of all by expediency and practicality. For instance, with the pockets of work trousers the pockets should be ergonomically located and they should be ample enough to store tools or hidden inner pockets should be designed. In the case of protective suits closures, slits, covered with flaps are applied.

The form, colours, system of signs of uniforms are determined by regulations and internal rules. With uniforms the designer has more freedom concerning the design of the form and, in addition to expedience, paying attention to the expectations concerning corporate image, is particularly important.

### **Selection of the fabric**

The selected fabric will basically determine the properties of the clothing products. The structure, composition, finishing, etc. of the fabric will influence, from ergonomic point of view, the safety, wearing comfort, and the physiological characteristics of the product. Meeting the special expectations, set to the workwear, can be ensured - besides the natural fibres – by fabrics made of synthetic fibres (especially the newly developed fibres of the third and fourth generations) and by special material structures as well. Through the application of special finishing to the fabric it can offer fire protection or it can withstand the adverse effects of chemicals.

As far as the wearing comfort and the application properties are concerned it is important what sensation a textile produces upon skin contact, how easily it can be cleaned and how easy it is to care it. The air – and vapour permeability, heat dissipation and thermal insulation capability of the textile determine the physiological characteristics of the product.

The properly selected material combinations can offer further advantages, from ergonomic point of view, when designing the clothes. For instance, comfort and freedom of movement can be ensured with the combination of woven-knitted materials or the physiological properties can be made more favourable by using a porous, “breathing” lining.

### **Colours, patterns**

In the course of designing workwear the selection and combination of colours determine the image and the style. It is important to know the content of meaning of the colours and they should be chosen in accordance with the corporate image and suited to the given work, working conditions and work environment. For example, the use of dark colours in a clean, hygienic work environment should be considered or is it worth using light colours in a dirty work environment, etc. Usually single-colour materials are used for most workwear; however, it is always the type of the work that determines if patterns can be used or not. In some jobs the use of patterned materials can be kinder or more inviting, e.g. gowns of nurses, surgical cap, etc.

From ergonomic point of view the colours and patterns have an effect on the perception, detection and vision. They have an important role in creating proper security too. It is not all the same if the goal is blending in the surroundings (military fatigues) or, on the contrary, sticking out of the environment is intended (e.g. paramedic uniform).



The pattern resulting from the structure of the material can also produce an interesting sight (e.g. weaving in carbon fibres in the form of strips or blocks) but the protective function of the material is of primary importance.

From ergonomic point of view, choosing the proper colour contrasts helps perception and interpretation.

In the process of product design three kinds of colour functions can be distinguished. All the three functions appear together on the individual products but their proportions are different. (Nemcsics, 2004)

- Usage colour function that helps the user with the use of the product through the interpretation of the colours, e.g. by enhancing, separating the details. The correct selection of colours, in accordance with the type of the work environment, contributes to the identification of the product while the misleading use of colours has the opposite effect.
- Informative colour function that, in the case designing workwear and uniforms, has informative or work organization function referring mainly to the corporate image. The usage is unambiguously indicated on the clothing with informative detail solutions (e.g. variations of access to the pockets), add ons( labels logos, visibility stripes).
- Interpretation is helped by signs and sign systems based on common agreement.
- Aesthetic colour function by which the usage function becomes interpretable. The artistic expression is an important tool of producing emotional effects. Choosing the colours, utilizing their associative meaning, the prevailing fashion trends can be expressed by the aesthetic colour function. In the case of uniforms, this function ensures the unified corporate image.

### **Technical and technological solutions**

The application of the technical and technological solutions is basically influenced by the structure, design of the fabric and the type of the product. For example, in the case protective suits against rain, certain fabrics can only be fastened with welded seams or the seams have to be insulated.

The users' expectations and demands seriously influence the functionality of the product. Through technological solutions diverse variation possibilities, ergonomic designs, practical detail solutions can be provided for the products, thus further advantageous properties become available.

For instance, widths adjustable with zip, detachable accessories, storing pockets, etc. Choosing the proper type of seams more durable and stronger stitching can be made and thus the quality of the product can be increased. For example, properly chosen top stitches will not only result in a more durable product but also its look can be more characteristic.

### **Add ons, accessories**

Choosing the add ons (buttons, buckles, zips, etc.) will influence the functionality, aesthetic look and durability of the workwear.

The field of use of the product also determines the choice of the add ons. For example, there are protective suits with which the use of any kind of metal add ons shall be avoided or, with the seams of the ESD (electrostatic discharge) protective suits the use of silver braided thread is required.

As far as the add ons are concerned, with certain products the specifications of the relevant standards have to be taken into consideration, e.g. location and sewing on of the visibility strips.

The aspects of corporate image are also determining, e.g. the choice of the buttons, location of emblems on the clothing, etc. The look of the clothes can be completed by accessories like shawls, scarves, ties, etc.

On the whole it can be said that in all areas, determining the aesthetic, ergonomic and physiological characteristics (form design, choosing the fabric, determination of the colours and patterns, technological and technical solutions, selection and application of add ons and accessories), the designer is influenced by the following factors:

- standards
- specifications, recommendations
- aspects of expediency
- clients' expectations, image elements
- fashion trends (in the case of uniforms).

## SUMMARY

Because of taking account of the special requirements designing workwear is an extremely complex task. The product design orientated students of the Óbuda University can acquire the fundamentals of clothing design and ergonomic knowledge in university education. Through various project tasks and corporate assignments the engineering and project orientated students can learn and experience the importance and difficulties of this field and begin to appreciate its beauties as well.

## REFERENCES:

- [1] Becker, Gy., Kaucsek, Gy.(1998): *Termékergonómia és termékpszichológia.(product ergonomiy and product psychology)* Tölgyfa Kiadó, Budapest
- [2] F. Dózsa, K. (szerk.) (2012): *A Magyar Divat 1116 éve. (1116 years of hungarian fashion)* Absolut Media Zrt. Kiadó, Budapest
- [3] Flórián, M (2001): *Magyar parasztviseletek.(Hungarian peasant costumes)* Planétás Kiadó, Budapest
- [4] Hercegfı K., Izsó L. (szerk.) (2007): *Ergonómia. (Ergonomics)* Typotex Kiadó, Budapest
- [5] Kisfaludy, M. (2005): *Kreativitás, design és minőség a textilruházati iparban - A ruházati formatervezés oktatásának új aspektusai.* Doktori értekezés,(“Creativity, design and quality in the textile industry – new aspects in teaching of clothing design”, Doctoral thesis) Budapest
- [6] Murrell, K.F.M (1965): *Ergonomics.* Chapman and Hall, London
- [7] Munkavédelmi Törvény (MvT) (Occupational safety law). 1993. évi XCIII. törvény a munkavédelemrıl. [https://net.jogtar.hu/jr/gen/hjegy\\_doc.cgi?docid=99300093.TV](https://net.jogtar.hu/jr/gen/hjegy_doc.cgi?docid=99300093.TV) Megtekintve: 2017.09.09.
- [8] Nemcsics, A. (2004): *Szındinamika - Színes környezet tervezése. (Colour dynamics – Design of colour environment)* Akadémiai Kiadó Zrt. Budapest

## FASHION COLLECTION INSPIRED BY TRADITIONAL “BUNJEVAC” ATTIRE

**Mirjana Ristic, J. Skenderović, A. Milosavljevic, D. Joksimovic, M.Pesic**

\*Mitex Via Fabio Severo 11 34133 Trieste, Italy

\*Technical Faculty „Mihajlo Pupin“, University of Novi Sad - Đ.Đakovića BB 23000 Zrenjanin

\*Faculty of Technology Leskovac, University of Nis - The scholarship holder of the  
Ministry

### ABSTRACT

*The Bunjevci are considered to be the oldest national minority in Serbia. Despite the fact that they are the oldest national minority, research about their origin, language and tradition is lacking. This subject was not popular in academic circles. The most important research regarding this topic is considered to be the study of Jovan Erdeljanović. To support the fact that very little is known about this national minority, researches of the field still debate regarding their origin and authenticity to this day. The subject of this paper is important because of the preservation of traditional values of the Bunjevci who inhabit the region of North Bačka. During the centuries of their existence the Bunjevci, despite frequent migrations and forced assimilation, managed to preserve their language, customs and religion that makes them distinctive and unique.*

### TRADITIONAL ATTIRE

Traditional attire represents the basic indicator of ethnicity. The female traditional clothing just like the male traditional clothing came under various changes in different socio-economic circumstances. Nevertheless it is assumed that some parts of the traditional womens dresses remained authentic to this day. In its earliest edition it was produced from yarn and textile handmaid in the household. With time, under the influence of social circumstance, new forms of fabrics and decorative elements developed and were being used.



Picture 1. Two girls dressed in silk Photography by Ante Pokorni

## INSPIRATION FOR FASHION COLLECTION (EMBROIDERY)

Folk costume is one of the basic indicators of national identity, and as such has given me the opportunity to use its traditional elements to create a contemporary fashion collection. I find the main inspiration in the golden and whitework embroidery.

“Embroidery is the art or handicraft of decorating fabric or other materials with needle and thread or yarn. In this way, it has been practiced for decades.” Elaborately embroidered clothing, religious objects, and household items have been a mark of wealth and status in many cultures including the Bunjevac culture. Traditional folk techniques were passed from generation to generation. Techniques which were used include: golden embroidery, whitework embroidery, silk floss embroidery and tassels embroidery.

Goldwork embroidery is the art of [embroidery](#) using metal threads. The term "goldwork" is used even when the threads are imitation gold, silver, or copper. Goldwork is always [surface embroidery](#). Goldwork is used to decorate items like slippers, blouses, shawls, aprons, skirts, etc.



Picture 2: Photographs from the “BUNJEVAČKI BILI ŠLING” book (Subotica 2010)



*Slika 3: Photographs from the “BUNJEVAČKI BILI ŠLING” book (Subotica 2010)*

Whitework embroidery refers to the [embroidery](#) technique in which the [stitching](#) is the same color as the foundation fabric (traditionally white [linen](#)). Styles of whitework embroidery include most [drawn thread work](#), [broderie anglaise](#), [Hardanger embroidery](#). Whitework embroidery is one of the techniques employed in [heirloom sewing](#) for [blouses](#), [petticoat](#), underwear, and other articles, and it is a recognizable artform of the Bunjevac national minority.

**FASHION**

**COLLECTION**



FASHION SKETCH 1



TEHNICAL SKETCH

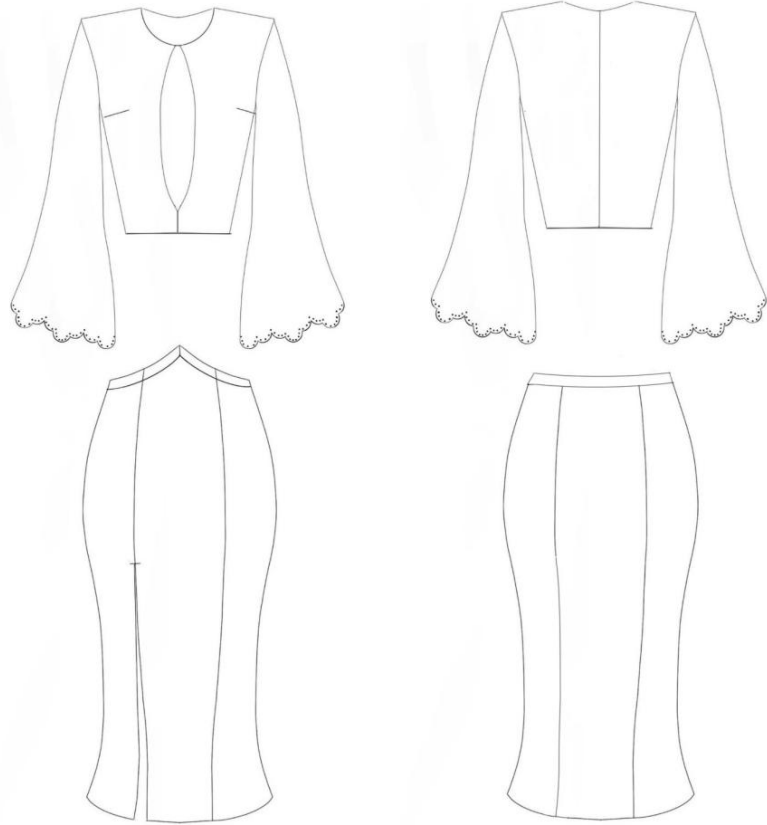

EMBROIDERY PATTERN

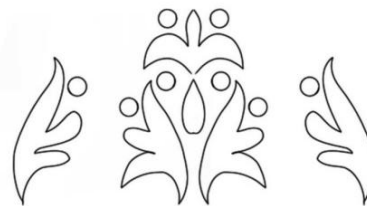

FASHION SKETCH 3



TEHNICAL SKETCH



EMBROIDERY PATTERN

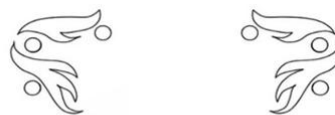



---

## CONCLUSION

Folk costumes, though a part of the cultural heritage, in the age of globalization in everyday life are largely suppressed. However we can find the inspiration for the clothing that we can use today, yet to incorporate piece of history and the tradition of the folk costume.

## REFERENCES

- [1] “BUNJEVAČKI BILI ŠLING” Subotica 2010
- [2] “STARA BUNJEVAČKA NARODNA NOŠNJA I VEZ” Subotica 1940
- [3] Hampton, F. P. , Harry, H. G., and Ko, F. K., ., Low-Cycle Fatigue Strength Of A Ductile Hybrid Fiber Reinforced Polymer Bar For Earthquake Resistant Concrete Structures, Proceedings, ICCM 14, San Diego, CA., Paper ID: 1295, July 14-18, 2004
- [4] Ko, F.K., Nanofiber Technology: Bridging the Gap between Nano and Macro World”, in NATO ASI on Nanoengineered Nanofibrous Materials, 2003, Anatalia, Turkey, Kluwer Academic Publishers
- [5] Formhals, A., US Patent # 1,975,504, 1934. Doshi, J., D. Reneker, H., J. Electrostat. 1995, 35, 151  
Gibson, P. W., Schreuder-Gibson, H. L., Riven, D., AIChE J. 1999, 45, 190

## INFLUENCE OF FASHION TRENDS ON DEVELOPMENT OF UNDERWEAR

**Irma Radovan, Ksenija Doležal\*, Renata Hrženjak**  
University of Zagreb Faculty of Textile Technology  
[irma.radovan@tff.hr](mailto:irma.radovan@tff.hr), [ksenija.dolezal@tff.hr](mailto:ksenija.dolezal@tff.hr), [renata.hrzenjak@tff.hr](mailto:renata.hrzenjak@tff.hr)

### ABSTRACT

*In the paper a historical overview of women's underwear development is presented, conditioned by fashion trends. In addition, influences of the body shape on the construction of female underwear was investigated, and based on several selected models, representatives of trends from particular period, underwear was constructed and modelled with the emphasis on desired silhouette shaping. The presented underwear from a particular historical period is adapted to contemporary models of women's underwear and today's fashion trends. Considering current researches of proportions, respectively shape of the female body, new models of underwear serve for achieving the desired silhouette.*

**Key words:** *underwear, clothing design, clothing modelling, body shape*

### INTRODUCTION

The act of getting dressed for people primarily served for protection from various external influences, and clothing had primarily a functional purpose. However, the culture of clothing developed parallel with civilization, and clothing thereby becomes a mobile assessment of the person's possession wearing the clothes. It becomes a communication tool that primarily gives the meaning of the symbol of social and socioeconomic status, but by it the affiliation to various ethnic, religious or sports groups is expressed, it expresses a certain profession or hierarchical level of power, and gender differentiation. Besides upper clothing, underwear as well has an important role in getting dressed. Underwear functions inside clothing as the most individual segment because it's usually not noticeable. Unlike the upper clothing which we give a meaning with the act of getting dressed, which is available to everyone in consideration, the underwear is protected and covered by the same.

However, the history of clothing and the history of underwear are intertwined and conditioned by each other because the desired upper clothing silhouette is achieved by appropriate construction and shaping of underwear pattern (Kojundžić at al, 2018).

### Historical overview of the underwear development conditioned by fashion trends

Throughout history underwear has mostly followed the shape of the upper clothing, and it takes a more significant role when it begins to shape the body. The beginning of the Italian Renaissance period signifies the period of its more significant influence on changing the body's silhouette (Thomass C. at al, 2011). The elements, with which the desired shape of the hourglass is achieved, are then introduced and the hips are emphasized and are getting wider, and the waist is narrowed. With this the period begins, when women's clothing was explicitly in the function of achieving body shape. In this period, the first variants of the corset and bustles appear, which deny the natural female body shape and create the ideal silhouette of narrow waist and wide hips (Grau F.-M., 2008).

Over the next few centuries, the canon of feminine beauty and desirable silhouette, through changes of cultural influences of ruling powers, does not experience any major changes, except for minor changes in emphasizing the hourglass silhouette (Grau F.-M., 2008). During the French revolution period, a rejection of previous rules occurs, followed by a gradual return of simplicity and lightness in clothing and, consequently, in the underwear (Grau F.-M., 2008).

The greatest changes in corsets shapes, its thickness, way of binding and function, appear in the 19th century. Namely, corsets are improved and made in such a way that with their use the desired silhouette can be achieved, and they support the body by straightening it, thereby forming the S shape. At the turn of the 20<sup>th</sup> century, there is a first significant change in the canon of women's beauty, when the women engaged in sports activities, they begin to reject a firm grip of the corset and adopt more comfortable versions of girdle that enter the fashion. Also complete covering of breasts becomes a trend. The turning point in the underwear history is the first patented bra that belonged to the American Mary Phelps-Jacobs, who merged two silk handkerchiefs into a simple design, with addition of ribbons. The period of World War I brings changes in everyday life for women, who were forced due the high flow of men on the battlefield, to replace them in jobs, they hadn't done until then. Then the complete release of the body from the corset has begun. Within this period, the woman's silhouette and underwear goes beyond the classic feminine figure with attenuated waist, accentuated breasts and hips, onto the girl's/boy's figure with lowered waist and with 'hidden' breasts. In 1926, the production of bras is started in such a way, that with their shape they fully follow the shape of the breasts (Thomass C. at al, 2011). As well than, the first anthropometric researches of the human body appear.

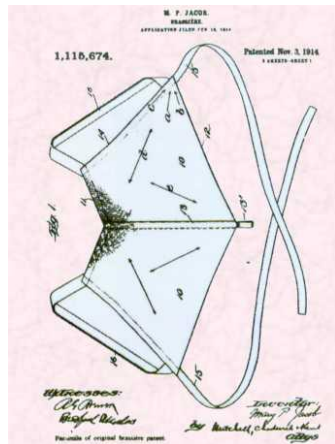

Figure 1: The first patented bra



Figure 2: The example of bra during the World War II

All mentioned contributes to a variety of choice and wider range of underwear, and the period before World War II marks the return of femininity by the invention of latex and the popularization of gaine (a long girdle, made of latex in various forms), and the models of underwear combined with suspenders. Above the girdle, which shapes the body, in this period a lot of attention is given to breasts and bras, as well as to overall aesthetics of underwear. In the 50s of the 20th century, Christian Dior represents his New Look and re-introduces the ideal silhouette of femininity, the hourglass. But the figure of the hourglass in those years with an extremely tightened waist and accentuated hips, even caricaturized lines with the then-popular 'bullet' bra that gives the breasts an excessively triangular shape (Thomass C. at al, 2011). The development of underwear is more significant in the second half of the 20th century as a result of the use of various new materials, but also of the weaving technique that broadens the spectrum of design possibilities. The underwear becomes more sensual and imaginative, and at the same time it is more lasting, lighter and more durable. The sixties of the 20th century were marked by the women's emancipation, by contributing to their ever greater self choice in choosing clothing and individualization.

Women begin to accept the return of natural, the dismissal of restraining clothing, and especially the restraint of bra. This is the time when the influence of high fashion drops, followed by growth of more cost-effective ready-to-wear made clothing (Lehnert G., 2000).

Such progress leads to a shift in researches of underwear, and at the end of the century many variants of push-up bras appear, for women who would like to increase their volume of the bust or embellish and push-up the décolletage (which only at the end of the century is experiencing a full comeback). Towards the end of the 20th century, a sensible social progress is also manifested in the novelty of surgical interventions that women undergo to achieve the desired silhouette, and although such interventions have been known for centuries, they are now becoming more secure and generally more acceptable. The appearance and progress of aesthetic surgery denotes the possibility of individual conditioning of the own body as desired, largely still in order to achieve the 'ideal' hourglass figure. The leading style icons today impose to their followers' monetary-costing trends in fashion, cosmetics, lifestyle and silhouettes, and today's beauty somehow stops being in the eye of the observer, but in the consistency in tracking trends (Thomass C. at al, 2011).

### UNDERWEAR IN FUNCTION OF BODY SHAPING

Wearing underwear greatly contributes to shaping of the body. Considering today it is possible to make underwear that almost fully adapts to the body, knowledge of body measures and its structure is needed. Namely, the design and shape of the underwear then adapts to the body, and it is made in a way, that by wearing it, one can achieve the desired look. Collecting physical dimensions data allows the performance of anthropometric measurements. Therefore, based on the data of anthropometric researches of women in the Republic of Croatia, the dimensions of breasts, waist and hips circumference are determined, Figure 3 (Doležal at al, 2018).

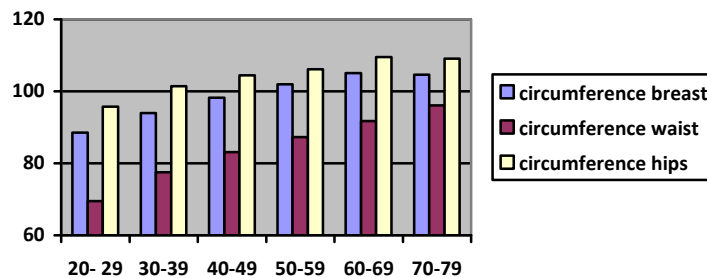

Figure 3: Average breast, waist and hips circumference of women by age group

According to the result, a greater increase of the waist circumference value is noticed, especially with increasing age. From that follows that the most important task of the female underwear is to assure corrections in the waistline area. The mentioned results are extremely significant because they assist underwear manufacturers to adapt their product to actual customers' needs.

### EXPERIMENTAL PART

Based on previously mentioned, and on modelling procedures, underwear models were modelled inspired by the 20<sup>th</sup> century underwear, Figure 4,5,6.



Figure 4: Model 1, bra example from the beginning of the 20<sup>th</sup> Century, 'Brassiere'



Figure 5: Model 2, example from the middle of 20<sup>th</sup> century bra, 'Poirette' [11]



Figure 6: Model 3, example of underwear from the end of 20<sup>th</sup> Century, babydoll-Pinterest [12]

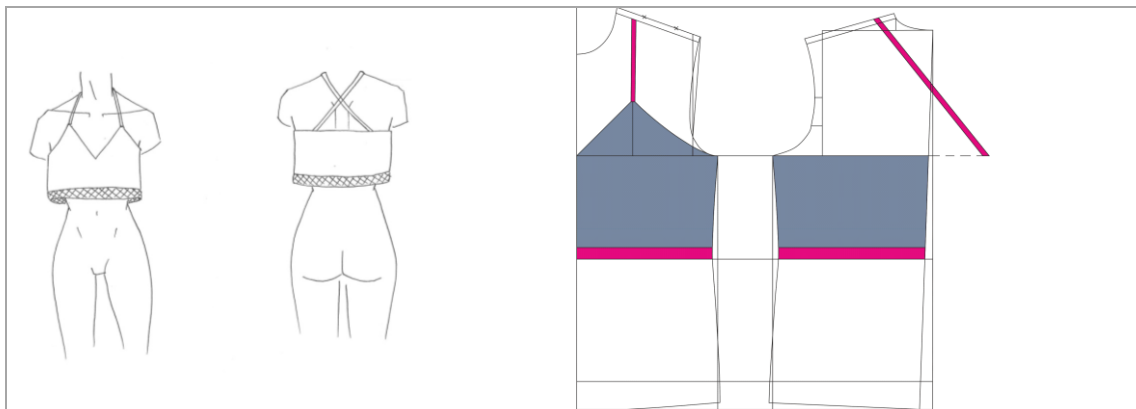

Figure 7: Sketch of a model inspired by model 1

Figure 8: Pattern modelling according to model 1 sketch

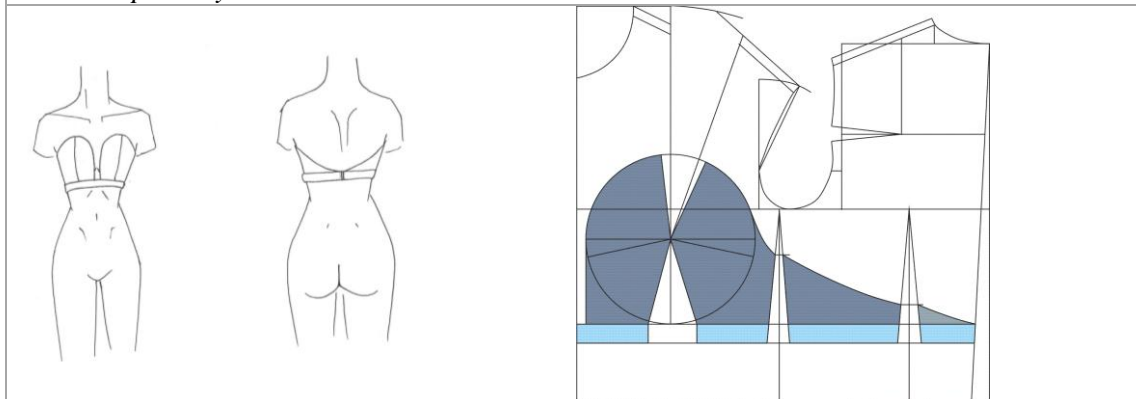
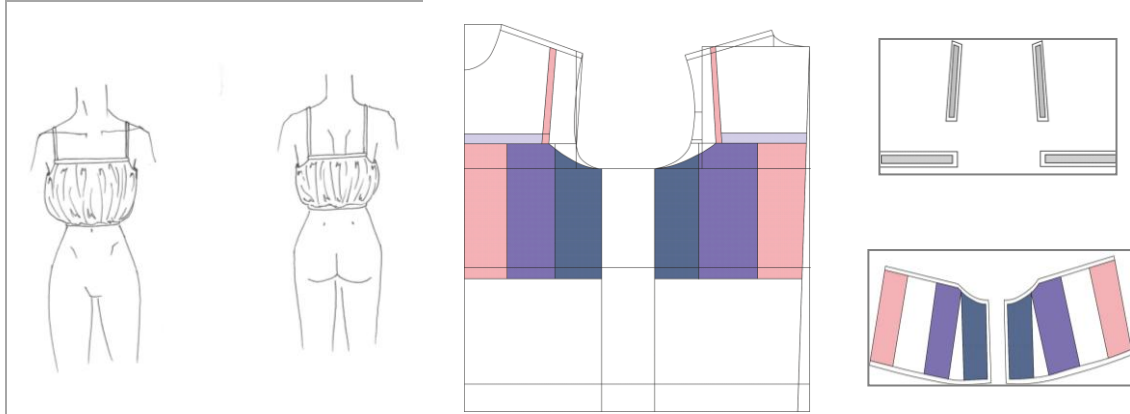

Figure 9: Sketch of a model inspired by model 2

Figure 10: Pattern modelling according to model 2 sketch  
 3



*Figure 11: Sketch of a model inspired by model 3*

*Figure 12: Pattern modelling according to model 3 sketch*

## DISCUSSION

New models of underwear compared to the models from the 20<sup>th</sup> century, which served as inspiration, are slightly different. The reason for this is today's variety of clothing, which covers almost all styles, which can be especially noticed in current women's underwear market offer. Given the knowledge of body dimensions, by wearing the shown models, it is possible to correct the silhouette and approach it to desired hourglass shape.

According to the mentioned research, the first model visually attenuates the waist, and is intended for women with a smaller value difference in circumferences of breasts and waist, as it will further emphasize the breasts because of its broader pattern.

The second model is intended for younger women for the reason the model with its pattern fully follows the body outline and cannot serve as a correction, but can only emphasize its natural shape. The third underwear model is significantly wider; it narrows in the waist area and completely adjusts to its circumference. The underwear of this shape is intended for all age groups, since this shape always narrows the waist and the body visually approaches the appearance the hourglass shape. All three models can also be worn as upper clothing.

## CONCLUSION

If clothing makes a man, underwear is a reflection of human aspirations and tendencies. A human is the only being who covers the body since its origin. Regardless of whether it is the original impulse of shame, cold or aesthetics, a human has long been working on improving and adapting his surroundings through various technological and cultural advances, and a special attention is given to clothing throughout history. Underwear in the 21<sup>st</sup> century can serve to original, exclusively functional purposes for warming up and physical protection, can have an erotic purpose in everyday life or in various fetish cultures, and can serve as upper garment and can be shown publicly and consciously, which also indicates the blurring of shame limits which comes with today's liberal period in which we live. The silhouette that is to be achieved today as well, is the hourglass shape with preferably natural, but also surgically modified and enlarged breasts and behind, and attenuated waist. Today, all kinds of underwear are produced, but the girdles somehow longest remained in use, because women will never be as much satisfied with their appearance, that they will not try to correct it and dress to conceal the imperfections and emphasize the curves by highlighting their breasts and hips, or attenuating their waist.

## REFERENCES

- [1] Doležal K., Hrženjak R., Kojundžić I. (2018). *The impact of underwear on the shape of a woman's body*, VI Scientific-vocational Conference with international participation "Development tendencies in the textile industry – Design, Technology, Management", Savanović Goran (ur.). Beograd, The College of textile design, technology and management, 106-109
- [2] Grau F.-M. (2008). *Povijest odijevanja*, Kulturno informativni centar, Naklada Jesenski i Turk, Zagreb
- [3] Kojundžić I., Grilec A., Doležal K., Šabarić I. (2018) *Launching a New Brand of Women's Underwear*. *Textile & Leather Review* (2623-6257) 1 (2018), 2; 64-71
- [4] Lehnert G. (2000). *A History of Fashion in the 20<sup>th</sup> Century*, Könemann Verlagsgesellschaft, Ed. Delius P., Germany, ISBN 3-8290-2033-3
- [5] Thomass C., Örmén C. (2011). *Povijest donjeg rublja*, Duh vremena, Alfa, Zagreb

### Figure:

- Figure 1: Fashion era: <http://www.fashion-era.com/undergarments.htm>, (Accessed on 20 August 2018)
- Figure 2: Brassiere: <https://www.metmuseum.org/art/collection/search/80095450>, (Accessed on 19 July 2018)
- Figure 4: Brassiere: <https://www.metmuseum.org/art/collection/search/80033016>, (Accessed on 29 August 2018)
- Figure 5: The Guardian: <https://www.theguardian.com/artanddesign/gallery/2014/jun/03/intimate-apparel-a-history-of-lingerie-in-pictures>, (Accessed on 21 May 2018)
- Figure 6: Pinterest: <https://www.pinterest.ie/pin/727894358497029751/>, (Accessed on 18 August 2018)

## TEXTILE MATERIALS IN MEDICINE

**Slavisa Djurdjevic, Nevena Igić, V. Petrovic, A. Milosavljevic, D. Joksimovic**

\*Singidunum Sverige AB - Konultverksamhet inom textil och kläder, Tröllhättanstad, Sverige,

\*Technical Faculty "Mihajlo Pupin", Zrenjanin, - Đure Đakovića bb, 23000 Zrenjanin

\*Faculty of Technology Leskovac, University of Nis - The scholarship holder of the Ministry

e-mail: [nigic92@gmail.com](mailto:nigic92@gmail.com)

### ABSTRACT

*Huge development of science and technology in the past years are enabled to researches development of new ideas and responsibilities in different segments of life, including medicine and medicine textiles. Use of textile materials in medicine is huge, and development of this material is on very high level. E-textiles are in the focus, actually on the sensors that are used in medicine, more effective wound care, medicine implants and uses of intelligent textiles for surgical products.*

**Keywords:** *textiles, medicine, material.*

### 1. INTRODUCTION

Needs of every human is to improve quality of life and life style. Lifespan of human is improved with health development. In the last decade were researched many test in nanotechnology, information technology, electronic devices with goal to improve the lives of people. The world is more attention to smart and intelligent textiles, particularly in medicine.

The use of medicine textile dates back to 5000 years before the Christe, when were used cotton, silk and flax for wound dressing, thread for seams. The more attention physical qualities it's dedicated in the end of XIX and start of XX century, when they make a large number of researches physical, chemical and morphological fiber characteristic. In 1890 is developing fake silk "Rayon" and "Viscose", and mercerization of cotton was discovered. Manual use of pure viscose has led to discovery of the first artificial fibers. With new discovery comes a revolution in textile industry and textile materials tend to be specialized. The use of textiles in medicine is multidisciplinary because of specific characteristics such as flexibility, dimensional variability, low weight, achievement of special properties with surface and structural modifications. This textiles are called smart textiles, and they have the characteristics of conventional textiles and have additional functional values.

Market medical textiles account for 10% of Europe's technical textile market and tend to be 12%. The European market produces 100000 tonnes of fiber per year and this quantity is increased by 3-4% per year. The potential of the market for medical textiles and health care is growing rapidly, and the factors that influence this are shown in Picture 1.



*Figure 1: Factors affecting the healthcare market and medical textile appliances*



## 2. MATERIALS AND METHODS

### 2.1. Smart medical textiles

The term "smart textiles" includes a wide range of products as well as a large number of studies on the increase in the function of conventional textiles. Smart textiles are defined as filaments with knitted, woven or non-woven fabric. All structures are able to feel the environment and stimulation, as well as to respond to them. The answers can be mechanical, chemical, thermal, magnetic, electrical or some other sources. According to the type of reaction, smart textiles are divided into:

1. Passive smart materials
2. Active smart materials
3. Very smart materials

Passive smart materials are materials that feel the environment and stimulants. They are known as "Sensors".

Active smart materials are materials that also feel the environment and stimulants, but also have the ability to react to them. In addition to sensory reactions, they also have activation characters.

Very smart materials are materials that have the ability to feel and respond to environmental conditions and stimulants as well as the ability to adapt them to the prevailing circumstances.

#### PAMETNI MATERIJALI - EFEKTI

- Efekti pokretača (obnuti efekat)

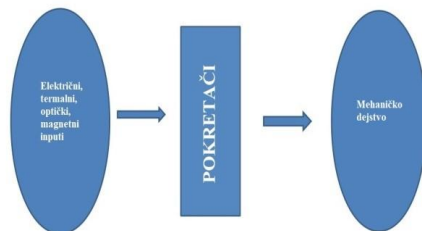

Figure 2: Very smart materials

#### PAMETNI MATERIJALI - EFEKTI

- Efekat senzora (direktan efekat)

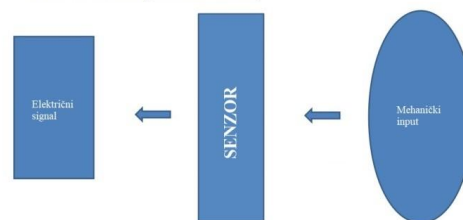

Figure 3: Sensors

The use of textile materials in medicine begins with plain gauze, tissue reconstruction, wrapping materials and various prostheses for permanent body implants, temporary orthoses, and others.

Nano fibers have wide application in tissue kinetics and reincarnation due to their distribution of pore size and large surface area. Nano technology is increasingly used to improve textile characteristics, its durability, airiness, softness, water repellency, anti-microbiological properties.

Knitted and woven materials are used to a great extent for the production of gaiters for hernia and in surgical procedures without blood transfusion.

Hollow fiber membranes are used for heart surgery, while knitted textiles are used for seams and replacement of tendons and ligaments.

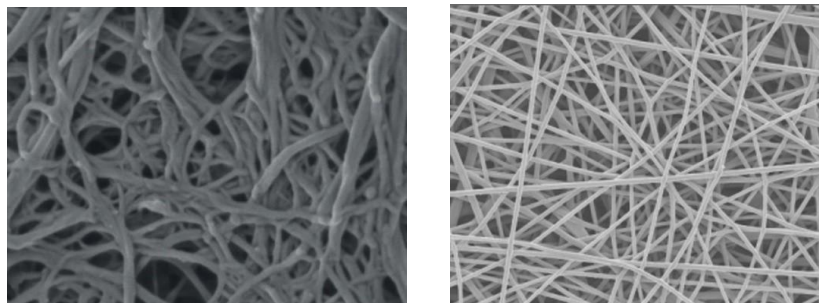

Figure 4, 5: Nano fiber

## 2.2. Textile systems of slow release

Textile slow release systems are used in the image when conventional dosage forms (fats, injections, tablets ..) can not be used. Using this system it is possible to work directly, and consequently the concentration of the drug that acts is higher. This method of administration is also very useful when it comes to a patient who is unconscious when it comes to novice.

These systems are:

- Textiles containing cyclodextrin
- Textiles containing ionizing fibers
- Medicines that are applied to hollow fibers
- Textiles containing fullerene
- Textiles containing aza-crown ethers

When incorporating and using these systems it is important to establish that they do not cause secondary side effects that may affect other vital functions of the patient, otherwise they would not be useful.

In the future, this segment will further develop different systems for embedding smart textiles in order to get different slow-release systems.

### 2.2.1. Textiles containing cyclodextrins

Textile containing cyclohexatriene is a textile material on which the cyclodextrin molecules intertwine. Cyclodextrins can be defined as cyclic alpha-1,4 linked oligosaccharides, formed from numerous D-glucose units. There are alpha-, beta- and gamma-cyclodextrins.

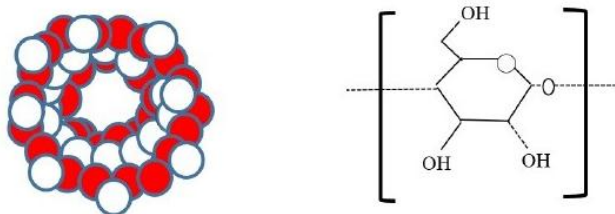

Figure 6: Cyclodextrins structure

They have hydrophilic puffiness and hydrophobic exterior and as such are important in the composition of this type of drug. Its compounds can be reactive, less hydrophilic, more hydrophilic or Ionic origins.

For cyclodextrin in textile it is important that the basic material is biostable and biodegradable - cotton, wool and synthetic materials are biostable. The body can not harm it, but UV radiation, weather conditions and microorganisms are detrimental to this kind of textile.

### 2.2.2. Textiles containing aza-crown ethers

Instead of cyclodextrin, as an alternative, textile materials are added to aza-crown ethers. They can be defined as neutral and microcyclic polyether molecules where oxygen atoms are completely or partially replaced by nitrogen.

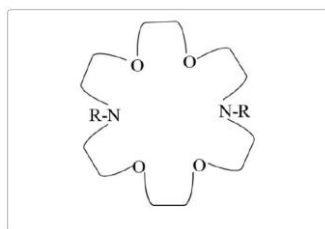
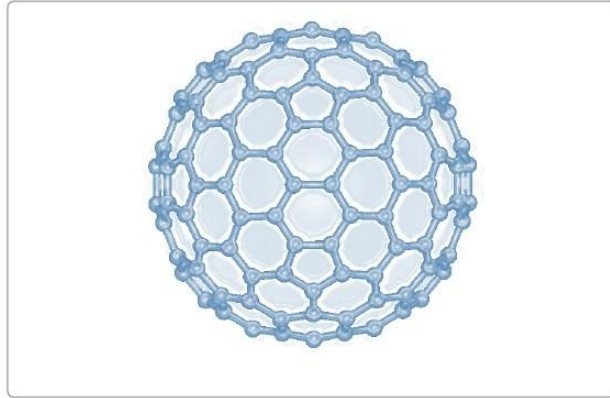

Figure 7: Structural formula azo-crown ether

These textiles are not toxic and carcinogenic, but their biodegradability depends on the basic material.

### 2.2.3. Textiles containing fullerene

Fullerene are allotropic forms of carbon. They are olefinic, electrophilic and participate in several additive reactions. Used on wool, PET and PA 6.6.

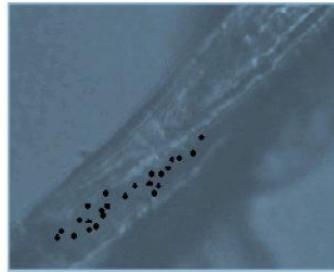

*Figure 8: Fulleren structure*

### 2.2.4. Hollow fibers in which the medicine is found

Hollow fibers are defined as small tubes filled with medication. Charges consist of a solution of the drug or liquid medicines. This system consists of a permeable membrane. The membrane has the role of controlling the release of the medication. Hollow fibers have two advantages:

- The ratio of surface and quantity is high
- Flexibility when charging is high.



*Figure 9: Hollow fibers filled with medication*

An alternative to these fibers are hollow fibers containing ion-exchange resins or crystals dispersed in a polymeric core.

Material used as a matrix is a conventional material that is non-toxic and non-carcinogenic (polyethylene and nylon). A toxic effect can occur due to the high dosage of the drug in hollow fibers. The biodegradability and biostability of hollow fibers depends on the material used to make walls.

### 2.3. E-textile (sensors)

E-textile products are smart health monitoring devices and sensors within the clothes that have the ability to record and feel basic physical functions such as breathing, body temperature, heart function... They perform data transfer with the help of mobile phones, the Internet ... to homes health, hospital, ambulance. This approach reduces costs, but also ensures the safety of the patient's health.

Textile sensors used in therapy and physiological monitoring vary in functions and applications, technological solutions and materials, degree of integration ...

There are four general categories of sensor structure:

1. Fiber-based, when the sensor is one yarn
2. Textile integration, when textile carries the carrier function
3. Textile structure, when all components of the converter are textile material
4. Textile-based, where the textile is a substrate or other insensitive but inseparable compound of the inverter.

The sensor structure is implemented using technologies such as thin films, coating, lithography, indoor printing ...

Optical fiber technology has been widely implemented in smart textiles for the purpose of forming sensors. Fiber optic sensors can be divided into:

1. Internal sensors - optical fibers consist of a sensor element
2. External sensors - optical fibers are used as a means of transporting light

Optical fibers have wide application due to their characteristics - low sensitivity and low zero speed, high bandwidth, good accuracy, immunity to electromagnetic waves .. and because they are cheap, flexible, lightweight, powerful and can measure high stress values without causing damage. The second classification of optical train sensors is based on their working principle:

1. Sensors FBG sensors have a periodic reflectivity index of the reflection together with the length of the fiber core, which is achieved by exposing the core to an intensive optical impedance scheme.
2. Modular Optical Sensors with Intensity - these sensors modulate the intensity of light. This intensity is measured using a secondary element - photodiode.

There are different types of smart textiles:

- **Sensing harness** - sensors that are tactically placed in the sensor network. It is used to measure abdominal and chest disorders due to breathing without mixing and overlapping the signal. They are designed so that they can be worn by both sexes. This network of sensors is similar to the design of the vest. Some parts have been released to facilitate resuscitation in a likeness of need. For the chest, a FBG sensor with high accuracy and low strain is used, while macro bending sensors with lower accuracy are used for the abdomen.

- **Polyurethane sensor** - sensors applied in the form of a paste (polyurethane) on woven textile. A high energy and smooth interconnect layer is created. At the top of the layer, the silver paste is painted to ease the conductive path.

Silver paste can also be applied on non-woven textiles - in this case they are used for health monitoring devices - ECG, breathing, heart rate and temperature.

- **Resistive tensile sensors** - these sensors are also used to monitor body parameters. This type of sensor monitors breathing, movement, blood pressure, heart rate.

- **Temperature sensors** - these sensors have the ability to monitor body temperature on the surface of the skin and in the body's environment. The data provided by these sensors are used to improve patient comfort, physiological assessment, and wound healing monitoring.

- **Breathing sensors** - Optical fibers are used for these sensors. These sensors are used for monitoring during sleep and in chronic respiratory disorders. Often they are incorporated in combat clothes. The knitted device is made of stainless steel yarn. These sensors are worn around the chest.

- **Moisture sensors** - textile materials used for these sensors must be hydroscopic - they must easily absorb vapors in the environment. These sensors have wide application in sweat monitoring, wound healing and ulcers.

- **pH value sensors** - these sensors are an important aspect in controlling sweating and wound healing. phositive textiles are used for the collection and storage of sweat and the monitoring of wound healing. these sensors are used in recovery and emergency cases, intensive care units during anesthesia.

#### 2.4. Smart textile for wound care

Care of the wound is very critical, because irregular care can lead to infections that can be life-threatening for the patient. The wound is defined as tissue breakage due to injury or surgery, while healing of the wound can be defined as the natural process of skin tissue regeneration.

Wound healing has four stages:

- Homeostase
- Inflammation
- Formation of granulation tissue
- Remodeling

These four phases overlap.

In order for the tissue to regenerate smart textiles as soon as possible and in as painless as possible, it should have the following characteristics:

- Should not cause mechanical damage
- It should have medicinal properties
- It should reduce the surface of adhesion
- It should have a stable and spatial structure
- Loose fibers should not be caught in the wound
- Permits painlessly change the cladding
- It is easy to absorb lymphatic fluid
- The progression of wound healing should be continuous
- It should control local temperature and pH
- Stimulate growth factors
- It should be elastic and biocompatible
- To maintain moist surrounding around the wound
- Allows the diffusion of gases
- To have an effective and cosmetic application

The various types of treatments used to treat wounds are:

- Fabrics made of cotton yarn / gauze treated with chitinous polymers
- Wound pads in the form of cytosan prepared by the Elektrospining method
- Cytosan films for wound care applications
- Wound care system, composite wound / non-wound barriers

Smart textiles for wound care function in a wet environment, do not require frequent changes, reduce pain and scars.

## 2.5. Medical textile implantable devices

Implantable medical textile devices are defined as materials used in the internal parts of the body for the treatment or repair of internal wounds such as surgical wound sewing during surgery. Textiles used for these devices should be non-toxic, biocompatible and biodegradable wherever possible. Non-biologically degradable implants such as steel, ceramics, titanium, carbon, silicones are intended to remain in the body for a lifetime.

*Table 1: Some of the main materials used as medical textile implantes*

Application	Materials	Textile structure
Artificial leather	Citin	Non-woven
Eggplant	Collagen	Multifilament
Artificial chain	Polyester kelter / Low-density fiber	Woven Fabric
Thistle and Butt Regeneration	Polypropylene - monofilament	Knitted
Arteria	Polyester teflon / texture	Knitted, woven, non-woven
Heart closures	Polyester multifilament	Knitted, woven - 2D
Vascular grafts	Polyester PTFE - multifilament	Varp knit
Seams	Polyester, nylon, silk, collagen / mono / multifilament	Knitted, woven
Artificial bone	Carbon, polyacetate, polyethylene / multifilament	Knitted, woven
Artificial ligament	Polyester, silk, PTFE, polyethylene / multifilament	Knitted, woven

Materials used for textile medical implants are:

- artificial eye lenses
- ear pipes
- Arterial stents
- Artificial knees
- IUDs
- Breast implants
- a heartbeat poem
- Artificial hips
- implantable cardioverter defibrillator
- artificial heart valves
- artificial vascular grafts
- artificial tendons
- artificial ligaments
- artificial leather
- artificial heart, kidneys, lungs

Textiles used for health protection should be biocompatible, should be airtight, dimensionally stable, resistant to alkalis, acids and microorganisms, good elasticity and absorption. Health care products for textile protection are:

- Surgical dresses made of cotton, polyester and polypropylene
- Surgical masks made of viscose and polyester
- Surgical caps of viscose
- Surgical curtains and polyester and polyethylene garments
- Surgical socks made of cotton and polyamide
- clothes, pillows, uniforms and other protective clothing made of cotton and polyester
- clothes and wipes from viscose and lyocell

In addition to all the aforementioned types of textiles used to protect people's health, there are textiles that are there to help people recover and maintain their physical mobility. These are special corsets / curves and orthoses.



*Figure 10: Orthosis*

**Orthoses** are medical devices used to stabilize, immobilize, guide or correct limbs or hulls. They protect and support the musculoskeletal system. Compared with the turn, they are more stable and have partially incorporated mechanics.

Orthoses can help in a wide range of indications. Usually they are proposed by the doctor together with the orthopedist. They can be used as a fiction to help with treatment when temporary immobilization is indicated. In other forms, orthoses stabilize the joints or lead them physiologically correctly. This can also be used to train relevant muscle groups, and hence strengthen them. In case of chronic or incurable damage, orthosis can relieve stress and support mobility. They can maintain function and prevent or reduce pain. In their corrective function, they are opposed to mistakes in shape, irregular attitudes and inaccurate workload, and in this way prevent physiologically undesirable development.

Whether it's immobilization, mobility, rectification, stabilization or ease of orthoses, they are persuaded by the comfort, the best handling and the attractive design.

**Ties** are elastic fabrics or knitwear that stabilize joints and bones in joint disorders or after sports injuries. The bandages can also be used primarily for prophylaxis in sports. In this function, they protect against excessive use and injuries. Whether the treatment or prophylactic, the shoulder, elbow, arm, palms, forehead and knee shoulder support and relieve pain. Ties promote flexibility, deliver safety and a better feeling. Defined compression reduces swelling and bruising and helps in treating.

Curtains offer high wearing comfort through high-quality, breathable materials that are specially adapted to the application. They absorb moisture and sweat, and special areas in bending and stretching provide a pleasant feeling on the skin. They discreetly promote movement, protection, soot and activate joints and bones.

### 3. CONCLUSION

The study of textile materials, through their properties, structure and characteristics, is now at an enviable level. Textile materials are now an essential part of biological circuits. Medical textile products aim to make life easier for their users. They have enormous potential for innovation and retain a large number of researchers, which tells us that it has not yet been fully detected and guarded.

### 4. LITERATURE

- [1] <https://www.omicsonline.org/open-access/impact-and-scope-of-intelligent-textiles-in-health-care-jbb-1000364-95733.html>
- [2] <https://www.go-textile.de/>
- [3] V. Petrović: (2004), Developmental trends of clothing companies in the function of training for quick responses to the demands of the market of earth-moving consumer clothing, I Scientific-expert meeting of Textile Industry of Western Serbia, Regional Chamber of Commerce Užice, December 2004, Arilje



## RESEARCH REGARDING THE DEVELOPMENT OF FUNCTIONALIZED TEXTILES BY USING PLANT EXTRACTS WITH BIOACTIVE PROPERTIES

Pricop Floarea<sup>1</sup>, Popescu Alina<sup>1</sup>, Chirila Laura<sup>1</sup>, Rascov Marian<sup>1</sup>, Scarlat Razvan<sup>1</sup>,  
Cerempei Angela<sup>2</sup>, Muresan Emil<sup>2</sup>, Moga Corina<sup>3</sup>

<sup>1</sup>The National Research & Development Institute for Textile and Leather, Bucharest, Romania  
e-mail: [certex@ns.certex.ro](mailto:certex@ns.certex.ro)

<sup>2</sup>Gheorghe Asachi” Technical University of Iasi, Faculty of Textiles, Leather and Industrial  
Management, Iasi, Romania

<sup>3</sup>DFR Systems SRL, Drumul Taberei 46, Bucuresti, Romania, [dfr@dfr.ro](mailto:dfr@dfr.ro)

### ABSTRACT

*The research is based on the commercial interest of SME partners in the production and selling of new textiles that are promoting the wellbeing, by immobilizing the biologically active compounds within the textile part which comes in direct contact with the skin. Also, this research aims to develop an ecologically efficient environment and the bioprocesses functionalization for health care and environmental protection.*

*The target applications are textiles used in close contact with human skin with benefits in terms of life quality, being made of natural extracts from plants and through ecological processes.*

*As projects' results in which the experimentations have been performed, the technological knowledge of aromatherapy, the biologically active compounds compatible to the fabrics and the technological way of immobilization will be proved by laboratory simulated industrial process, up to pilot and industrial scale application.*

*The application methods of the polymerbioactive selected by compound systems will be optimized from technological, quality and therapeutically point of view.*

**Keywords:** *aromatherapy, antimicrobial fibres, bioactive textiles, extracts from plants.*

### INTRODUCTION

There is a growing demand on the market for biological and green products and in the textile field the offer is still poor. In addition, the increasing significance of branding makes important the role of the research of aromatic and therapeutic textiles products.

The surveys suggest that the retailers' market share will increase, keeping their leadership in their market niche, if they connect on an emotional and qualitative level to the end consumer.

The expected impact of the research results open the way for design of applicable and affordable techniques by using biologically active compounds from plants. This covers the whole manufacturing chain, starting from different essential oils, bioactive compound systems and new application techniques on functionalized textile materials up to development of aroma therapeutic garments and skin care products.

These applications will allow the companies to find new niche markets and increase their global businesses.

The research allows the supplying of the processes and services to the partner companies that will obtain higher quality so that to increase their revenues and permit the introduction of functionalized products on the new markets.

**MATERIALS AND METHODS**

For this research they were used essential oils extracted from: lavender, rosemary, mint, thyme were studied and selected to be used for the treatment of textile materials by various finishing processes.

The main categories of functional effects considered in the project are: skin hydration and anti-acne, revitalizing and reducing stress, improving of microcirculatory blood flow and cellular metabolism, fragrance and aromatherapy, cellulite reduction (Figure 1).

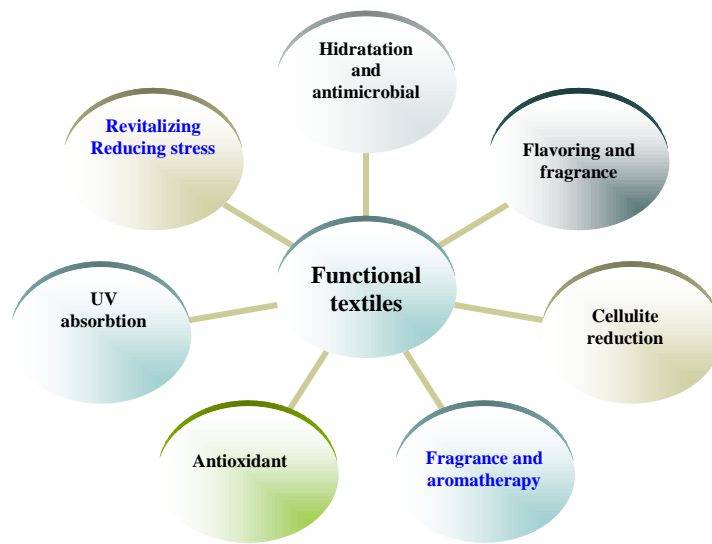

*Figure 1: Functional effects*

The "cosmetic textiles" are created by micro-encapsulation, grafting, nanotechnology and coating techniques by incorporating various body care and health products that are gradually transferred to the skin through movement, pressure, or the effect of natural skin heat (Figure 2).

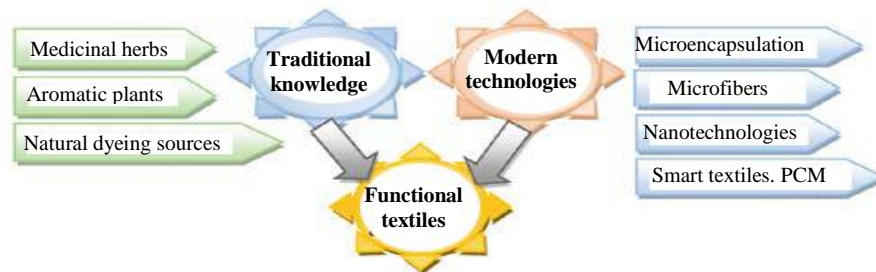

*Figure 2: Accomplishing ways for functional textiles*





Essential oils extracted from herbs: lavender, rosemary, mint, thyme, rose, sage that have been studied and selected to be used for the treatment of textiles through various finishing processes have been used for research essential oils extracted from lavender, rosemary, mint, thyme were studied and selected to be used for obtaining of aroma-therapeutic effects on textiles, as well as other various effects, such as: skin hydration and anti-acne, revitalizing and reducing stress, improving of microcirculatory blood flow and cellular metabolism.

### CHEMICAL COMPOSITION OF THE MAIN ESSENTIAL OILS USED IN THIS RESEARCH

The role of these oils in plants is similar to that of the blood in the body. Fat-soluble structure of essential oils is similar to that of cells and tissues in the human body. This makes them compatible with human proteins and allows them to be easily identified and accepted by the body. Due to the fat-soluble structure and very small-size molecules, essential oils serve as transport agents that easily penetrates the cell membrane.

Only one application of essential oils is sufficient to stimulate and revitalize the entire body. A recent study has shown that essential oils are able to penetrate the barrier blood/ brain due to their small size ( $\leq 500$  amu) (Balabai, 1988).

*Table 1: The chemical composition of the main essential oils to be used in the project*

Essential oil	Chemical type	Main compounds Composition	Composition (%)	References
Peppermint 	Oxygenated compounds	Menthol Menthone Menthyl acetate Eucalyptol Isomenthone Neomenthol	36 21,24 6.92 6.58 4.71 4.06	Duhamela N. et.al. 2016 Skalicka-Wozniak K. et.al.2014 Timung R. et.al. 2016
Lavender 	Monoterpenes Oxygenated monoterpenes Monoterpene	$\alpha$ -Pinene 1,8-cineole Camphor $\alpha$ -Bisabolool $\beta$ -Pinene	3.4% 33.0% 23.1% 14.1% 4.1%	J. González-Rivera et.al. 2016
Rosemary 	Bicyclic Monoterpenes	$\alpha$ -Pinene	28.2%	J. González-Rivera et.al. 2016
Thyme 	Oxygenated compounds Monoterpenes	Oxygenated compounds Thymol Borneol $\gamma$ -Terpinene p-Cymene $\alpha$ -pinene	14.1–77.6 0.5–27.8 0.2–16.3 3.8–6.6 3.5–7.9 1.2–7.8	Jamali CA. et.al. 2013 Kumar A. et.al. 2010

## INFLUENCE OF THE PHYSICAL-CHEMICAL AND MICROBIOLOGICAL PROPERTIES OF ESSENTIAL OILS ON TREATED TEXTILES

The functional textiles treated with essential oils extracted from plants contribute as: antiseptic of the respiratory, analgesic, sedative and balancing of the central and vegetative nervous system (Bouhekrit et al., 2016; Leimann et al., 2009).

Indications: insomnia, neurasthenia, and in cases of palpitations of nervous origin of the heart, in general, in all cases of psychosomatic diseases. Due to its sedative effect it is recommended in migraines and other headaches.

Applied externally it is very effective to calm rheumatic pains, whether of joint or muscular origin. Useful in dislocations, sprains, contusions and muscular strains. As an antiseptic and healing agent it is used to wash ulcers and infected wounds, as well as in minor burns. Physicochemical properties and microbiological properties are presented in tables 2 and 3 (Cerempei, 2017; Zarrad et al., 2015; Al-Jabri and Hossain, 2016).

*Table 2: Physico-chemical properties*

Relative density	0.9400 – 1.0950
Density of alcohol	0 – 10 G.L.
Relative pH	4.50 – 8.00

*Table 3: Microbiological properties*

Determination	Limit (UFC/mL)	Method used
Aerobic mesophilics	105	NOM-092-SSA1-1994
Mushrooms and yeast	103	NOM-111-SSA1-1994
Escherichia coli	10	NOM-113-SSA1-1994

## STUDIES ON THE FUNCTIONALIZATION OF TEXTILES WITH PLANT EXTRACTS AND APPLICATIONS IN MEDICINE

Due to essential oils that can act both at local level and through odor, they have great important applications in many fields such as food, cosmetics, medicine, tobacco, textile, leather, papermaking, pharmaceutical and perfume industries (Hu et al., 2001).

Essential oils add much value to the textile materials. The most commonly used essential oil in aroma finishing is lavender essential oil due to its properties: anti-acne, antibacterial, calming, anti-inflammatory, treatment of eczema and dermatitis. The introduction of the concept of aromatherapy for textiles has brought increasing demands for consumers in terms of quality, comfort and functionality of textile products. There was a shift in their values.

Aroma finish is a process by which the textile materials are treated with bioactive systems (e.g., chitosan/ essential oil, alginate/ essential oil systems) and finally get the multifunctional properties such as therapeutic effects and a feeling of well-being and freshness in the wearer.

Aromatherapy textiles are used in medicine and alternative healing, home textiles, body-care textiles, household cleaning and cosmetic products.

The aromatherapy materials that first appeared on the market were socks for women who like fragrances. Hosiery and intimate apparel have been the more widely explored product categories to apply aroma finishing. In recent years, a number of companies around the world turned their attention to aromatherapy textiles. Woolmark™ is applying aroma technology to hosiery, lingerie, socks, outdoor clothing, underwear, carpeting and other interior textiles.

## THE BENEFITS OF COSMETOTEXTILES AND AROMATHERAPY

### The efficacy of the cosmetotextiles

The efficacy of the cosmetic textiles should be tested using the same testing tools & testing conditions as for cosmetics. The Group WG-25 agreed to set some guidelines to solve the complexity of this problem. The ISO/DIS 11930 test may be successful in testing the efficacy of cosmetic textiles, although this test is designed for cosmetic.

### Durability

The Group WG25 formed a separate subgroup to emphasize the durability aspect of cosmetic textiles. For fastness to washing, a lot of testing methodologies are recommended by this subgroup. The efficiency of a binder to bind microcapsules on a textile surface depends on the compatibility of the different interfaces of the products involved in the finishing process. The choice of binder adapted to fix the microcapsules can be finalized by making a comparison of the surface energy components induced by various components in terms of the contact angle. Generally, the adhesion of microcapsules is closely dependent on the chemical nature and structure of the textile substrates (Ghosha and Chipot, 2015).

### Perfume performance analysis

This analysis is required to test the performance of various perfumed textiles. Headspace gas chromatography/ mass spectrometry (Headspace GC/MS) is a specific technique used to analyze volatile compounds. A specimen is placed in an airtight closed sampling vessel and then subjected to a temperature with a known temperature profile. The vapors in the vessels are sampled to analyze the odor issues, for identification of polymer additives and for residual solvent analysis according to various ASTM standards like ASTM - D3362, D3452, D4128 (Salaün et al. 2009).

### The benefits of aromatherapy

- It's the fastest way to raise your personal vibration;
- Helps a lot of healing processes;
- Increases the power of medication assimilation;
- Maintains a reference standard in thinking, feelings and human experiences;
- It gives great chances to special cases, prevents various aspects of bacterial and fungal diseases;
- It's a system for treating the environment in which people work;
- Creates a pathogen-damaging environment (viruses, bacteria etc.).

## CONCLUSIONS

The correlation of the bioactive extracts properties with the raw material type, fabrics and application technologies will contribute to the accomplishing of a large variety of functionalised textiles.

Antimicrobial fibres and yarns with encapsulated antimicrobial agents that prevent bacterial growth and keep the body in hygienic conditions for longer time, eliminate the possibility of creating unpleasant odours, refresh and facilitate breathing. Antibacterial microcapsules migrate continuously to the outside of the fibres until exhausted, creating a surface protection area. The clothing products made of this type of yarns maintain its antimicrobial effect after numerous washings (50-200).

The optimization of the quantity of cosmetic ingredients and enhancing the durability of cosmetic effect are the 2 real challenges in this field. Cosmetic textiles have to be designed so that the blend of the fabric, cosmetic finishes technologies and fashion to work together, in order to obtain an optimum cosmetic effect.

The research for the functionalized textiles are in progress and contribute to:

- increase the capacity of the companies to develop innovative products that meet the technical and functional performance level imposed by the effective international norms in the priority field "Health" and in the field of intelligent specialization "Eco-nanotechnologies";
- increase the added value for textiles by applying natural biologically active compounds with cosmetic and sanogenic function, contributing to increase the quality of life;
- diversification of the textile products for the companies.

## ACKNOWLEDGMENT

This work was supported through a grant of the Romanian National Authority for Scientific Research and Innovation, CCCDI – UEFISCDI, project number 29/2018 COFUND-MANUNET III-AromaTex, project title “Manufacturing of value-added textiles for aromatherapy and skin care benefits“, within PNCDI III and through the Nucleu Programme, with the support of MCI, project no. 16N/16.03.2018, PN 18 23 02 01, project title: “Sustainable solutions for obtaining functional textiles by applying biologically active compounds”.



## REFERENCES

- [1] Balabai, I., V. (1988), Rastenia, coterie nas leceat/ I.V. Balabai, A.C. Nistean, Chisinau, 351.
- [2] Boucekrit, M., Laouer, H., Hajji, M., Nasri, M., Haroutounian, S., A., Akkal, S. (2016), “Essential oils from *Elaeoselinum asclepium*: chemical composition, antimicrobial and antioxidant properties”, *Asian Pacific Journal of Tropical Biomedicine*, Vol. 6 (10), 851:857, DOI: <http://dx.doi.org/10.1016/j.apjtb.2016.07.014>.
- [3] Leimann, F., V., Gonçalves, O., H., Machado, R., A., F. (2009), “Antimicrobial activity of microencapsulated lemongrass essential oil and the effect of experimental parameters on microcapsules size and morphology”, *Materials Science and Engineering: C.*, Vol. 29 (2), 430:436.
- [4] Cerempei, A. (2017), “Aromatherapeutic Textiles”, *Active Ingredients from Aromatic and Medicinal Plants*, Hany El-Shemy, IntechOpen, DOI: <http://dx.doi.org/10.5772/66510>.
- [5] AL-Jabri, N., N., Hossain, M., A. (2018), “Chemical composition and antimicrobial potency of locally grown lemon essential oil against selected bacterial strains”, *Journal of King Saud University – Science*, Vol. 30 (1), 14:20. DOI: <http://dx.doi.org/10.1016/j.jksus.2016.08.008>.
- [6] Hu, J., Xiao, Z., Zhou, R., Ma, S., Wang, M. and Li, Z. (2001), “Properties of aroma sustained-release cotton fabric with rose fragrance nanocapsule”, *Chinese Journal of Chemical Engineering*, Vol. 19 (3), 523:528.
- [7] Ghosha, S., Chipot, N. (2015), “Embedding aromatherapy essential oils into textile fabric using  $\beta$ -cyclodextrin inclusion compound”, *Indian Journal of Fibre & Textile Research*, Vol. 40, 140:143.
- [8] Duhamela N, Martin D, Larcher R, Fedrizzia B, Barker D. Convenient synthesis of deuterium labelled sesquiterpenes. *Tetrahedron Letters*. 2016;57(40):4496–4499. 100 Active Ingredients from Aromatic and Medicinal Plants
- [9] Skalicka-Wozniak K, Walasek M. Preparative separation of menthol and pulegone from peppermint oil (*Mentha piperita* L.) by high-performance counter-current chromatography. *Phytochemistry Letters*. 2014;10:xciv–xcviii.

- 
- [10] Timung R, Barik CR, Purohit S, Goud VV. Composition and anti-bacterial activity analysis of citronella oil obtained by hydrodistillation: process optimization study. *Industrial Crops and Products*. 2016;94:178–188.
- [11] Jamali CA, Kasrati A, Bekkouche K, Hassani L, Wohlmuth H, Leach D, Abbad A. Phenological changes to the chemical composition and biological activity of the essential oil from Moroccan endemic thyme (*Thymus maroccanus* Ball). *Industrial Crops and Products*. 2013;49:366–372.
- [12] Kumar A, Shukla R, Singh P, Dubey NK. Chemical composition, antifungal and antiaflatoxic activities of *Ocimum sanctum* L. essential oil and its safety assessment as plant based antimicrobial. *Food and Chemical Toxicology*. 2010;48(2):539–543.
- [13] J. González-Rivera, C. Duce, D. Falconieri, C. Ferrari, L. Ghezzi, A. Piras, M.R. Tine. Coaxial microwave assisted hydrodistillation of essential oils from five different herbs (lavender, rosemary, sage, fennel seeds and clove buds): chemical composition and thermal analysis. *Innovative Food Science & Emerging Technologies*. 2016;33:308–318.

## PROTECTIVE CLOTHING

Martina Novak, J. Djukic, D. Joksimovic, A. Milosavljevic, M. Pešić

\*Czech Republic

\*Technical Faculty "Mihajlo Pupin", Zrenjanin - Đure Đakovića bb, 23000 Zrenjanin

\*Faculty of Technology Leskovac, University of Nis - The scholarship holder of the Ministry

e-mail: [jelenadjukic09@gmail.com](mailto:jelenadjukic09@gmail.com)

### ABSTRACT

*During the working process, protective clothing users are usually exposed to elevated temperatures, the action of toxic chemicals and gases. Suitable protective clothing is required for safe operation in such situations. The choice of protective clothing should be in accordance with the requirements of the work process, or risk assessment. In addition to functionality, protective clothing should be comfortable to wear, physically and physically acceptable, and made of suitable and high quality materials. The paper presents the types of protective clothing and the manner of their application. Protective clothing is a measure of the quality of life of an industrial society.*

**KeyWords:** *protective body, protective clothing*

### 1. INTRODUCTION

When performing various tasks, workers must wear suitable protective equipment. Workplace protective equipment can not completely protect against injuries, but can greatly reduce the consequences of various accidents on workers' health.

Various works can produce hazards such as sparks, sprays, radiation (infrared, ultraviolet, and blue light), metal heat, gas evaporation, and even electric shock. Since these hazards can cause burns, injuries or deaths, it is important that workers wear adequate protective equipment at all times. Generally, personal protective equipment must protect the worker from danger.

Workers wear eye protection and face protection, head protection, body protection, hand protection, hearing protection, foot protection.

### 2. PROTECTIVE CLOTHING ACCORDING TO PROTECTIVE PROPERTIES

Protective clothing protects workers from workplace hazards that can involve life-threatening situations. Clothing must meet the highest security standards and be in accordance with the requirements of the operating environment in which it is used. Typically, protective clothing has several protective functions, but the basic division relates to the main properties that fulfill the body protection.



Protective clothing according to the protective properties can be divided into:

1. protective clothing for protection against mechanical hazards
2. protective clothing for protection against heat and flame
3. protective clothing for welding protection and similar processes
4. protective clothing for static electricity protection
5. protective clothing for protection against rain and cold
6. protective clothing for reduced visibility
7. protective clothing for protection against chemical damage and danger

### 2.1. Zaštitna odeća za zaštitu od mehaničkih opasnosti

Clothing that provides protection against mechanical hazards protects the body from possible clogging caused by the embroidering of a piece of clothing by moving parts of machines, mechanical hazards that can arise from cuts and wounds caused by sharp and pointed objects as well as the splitting of parts and particles in the process of operation.

When there is a risk of engaging work clothing by elites that are mobile in the process of operation and can't be physically separated by protective means, it is necessary to ensure the use of protective clothing.

Requirements to be met by protective clothing:

- full coverage of other clothing
- adhering to the body
- smooth outer surface of clothing without prominent folds, pockets and outer seams

Forms of protective clothing:

- one-piece suit (overalls)
- two-piece suit (jacket and trousers)



*Figure 1. Examples of a clothing protection model for machines*

The clothes must be appropriate to the proportions of the body of the wearer, must cover the whole body surface, where the ends of the sleeves and socks must be attached to the body of the worker.

Two-piece sets must be worn together, and the size must be in accordance with the body structure so that during the performance of the operations, the separation between the jacket and the trousers should not occur.

The outer surface of the garment must be smooth, with no scratched elements, all the seams of the connected parts must be inside.

The labeling of the clothing must comply with the requirements of the standard, where the associated labels and pictograms must be affixed in such a way as not to endanger the worker's life.



Figure 2. a) A pictogram of clothing suitable for protection against movable parts of machines; (b) An example of unsuitable protective clothing

In manufacturing processes where there is an increased risk of injuries caused by stabbing and cuts due to the use of knives and sharp objects, the best way of protection is provided by protective aprons. Protective anchors must provide resistance to impacts on the entire surface of the protected area. The important factors that need to be considered in order to properly select adequate apertures are the type and quality of the knives with which the workers work, as well as the direction of knife movement. Apron is a garment which, depending on the model, must fulfill its protective properties, where ergonomic properties must also be met.



Figure 3. Types of protective quilt

Workers who handle the motor tester in their work are at increased risk of possible cuts and leg and arm injuries. In order to reduce this risk, protective clothing is needed.

Protective clothing for protection from cuts is divided into:

- lower body protectors (usually in the form of pants)
- upper body protectors (usually in the form of a jacket)

Materials from which these clothes are made often contain 7-9 layers of protective fabric made of long fibers of highly resistant material. Also, protective clothing must be as easy as possible taking into account comfort and minimal mechanical properties to ensure the robustness of clothing and resistance to the passage of matter beyond the protected surface.



Figure 4. Protective clothing for workers handling the motor tester

Clothes manufactured in accordance with the requirements of the cut-off safety standard with the motor tester must be marked, that is, in a visible place, a pictogram shall be placed beside which the class of protection of the appropriate garment item is indicated.



*Figure 5. A pictogram of clothing that protects the chainsaw*

2.2. Protective clothing for heat and flame protection

Clothes for protection against heat and flame are applied in conditions when the worker is exposed to elevated temperatures or direct flames in the performance of work tasks, which can endanger the health or life of workers.

Clothing intended for protection against heat and flame should completely cover the body, neck, legs and arms of the worker.

Thermal protective clothing depends on the type and properties of the material itself, as well as the way it is exposed, and hence it can be made as single-layer or multilayer. Multilayer protection ensures a higher level of security, but by its own production, garments become thicker and more difficult, and depending on the work of the clothing, they can be burdensome to the worker's body. The outer layer is made of materials that have resistance to high temperatures, and the inner layer must provide good thermal insulation and acceptable wearing comfort. Clothes must be suitable for the construction of the worker's body so as to allow for comfortable movement, as well as aerial insulation between the skin and the inner layer of the garment.

Labels or other details attached to protective clothing that protect against heat and flame should be avoided. Only elements made of non-flammable materials are used, so that the protective performance of the material is not reduced.

Clothing that meets the requirements with regard to the danger of high temperature and open flame is indicated by a pictogram indicating the level of protection level of clothing.

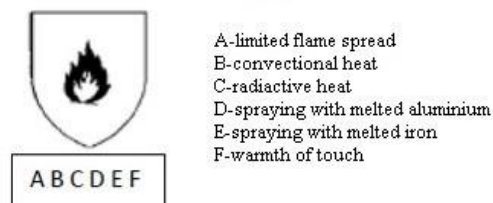

*Figure 6. Pictogram of protective clothing for protection against heat and flame*



*Figure 7. Protective clothing for firefighters*

### 2.3. Protective clothing for welding protection and similar processes

Protective clothing designed for welding processes is very similar to heat and flame protection, so design requirements are almost identical. The outer surface of the clothing must be smooth and completely closed so that the hot particles do not come into contact with the skin, or that they do not go through the clothes.

Design requirements:

- clothes are made as one-piece (overalls) or two-piece (jacket and trousers)
- the role of protective clothing is to completely cover the body, neck, legs and arms of the worker
- with a two-piece suit, changing the jacket and trousers should not be less than 20 cm in each expected position of the worker
- the outer pockets must be made of fireproof material, the covers must be at least 20 mm wider than the pockets
- clothing garments on the outside of the garment must have a protective shift
- the maximum permeation between the button must be 150 mm
- the door opening must be capable of closing
- socks must not have a prominent outer cuff

Clothes designed to protect workers during welding and similar processes provide protection from:

- convection heat
- radiation heat
- splitting of disassembled aluminum
- splashed iron spraying
- touch heat
- electric shock caused by short-term accidental contact with electrical conductors under voltage

Welding clothing that meets the prescribed requirements is marked with a pictogram with a mark



*Figure 8. Pictogram for protective clothing for welding*



*Figure 9. Protective clothing for welding*

## 2.4. Protective clothing for static electricity protection

Static electricity on clothes can cause such clothing to be uncomfortable to wear, and in an explosive atmosphere, there may be a potential danger to life. Therefore, antistatic clothing must be used which has the ability to conduct static electricity.

Electrostatic resistance of clothing is necessary when workers work in an area where sparks can cause explosion or fire (gas stations, flour mills). Clothing must be made of a material containing antistatic fibers and subject to anti-static pre-treatment.

Working protective clothing worn in zones where there is a likelihood of accumulation of static voltages has to have antistatic properties in its entirety. Such protection can be achieved by means of fabrics containing conductive metal fibers integrated into the fabric of which the garment is made. Protected clothing that meets anti-static properties must be in accordance with other protective clothing (socks, shoes), because electrostatic electricity is applied to the ground and shoes are the main connection in the conduct of electricity if there is no ground.



Figure 10. Protective clothing for static electricity protection with pictogram

## 2.5. Protective clothing for rain and cold protection

Protective clothing for protection against adverse weather conditions protects the body from rain, wind, fog, and the like. Depending on the level of protection and working conditions, the garment consists of several layers.

Rainproof clothing does not take into account UV radiation whose influence can cause aging of the material in the shoulder area and limit its anticipated lifespan. The use of rainproof clothing with an internal waterproof layer when selecting protective clothing should take into account the risk assessment of the workplace and on the basis of risk select the most appropriate protective clothing.

Requirements for rain protection clothing include:

- waterproofing
- water vapor resistance



Figure 11. Pictogram of protective clothing for rain protection

X - resistance to waterproofing  
 Y - the ability to leak body moisture



*Figure 12. Protective clothing for rain protection*

Protective clothing for protection against cold protects the body from a cold environment characterized by wind and moisture per temperatures below  $-5^{\circ}\text{C}$ . Clothes can be made as a one-piece overalls that cover the entire body or complete with a jacket and pants as a two-piece suit.

Requirements for clothing for protection against cold include:

- thermal insulation
- the ability to leak air
- the ability to leak moisture

When prolonged exposure to cold, the appearance of sweating should be avoided, since absorbed moisture gradually reduces the insulating properties of the garment. It is therefore important to choose the appropriate type of clothing depending on the working conditions that will be able to eliminate moisture and heat inside the garment.



*Figure 13. A pictogram of protective clothing for protection against cold*



*Figure 14. Protective clothing for protection against cold*

## **2.6. Protective clothing for reduced visibility**

Each class of protective clothing with reduced visibility requires a minimum of basic material as well as reflective material.

Clothing of high visibility can be a suit, coat, jacket, shirt, vest, trousers, shoulder straps.

Specific requirements for clothing design of high visibility:

- background material should include waist, as well as sleeves and socks where possible
- the reflective material strips must not be narrower than 50 mm (the exception is straps with ss 30 mm)
- the overalls must have two horizontal strips of reflective material that include waist at least 50 mm apart and inclined not more than 20 °
- sleeves and socks must include two strips of retro reflective material at least 50 mm apart
- the lower band of jackets, sleeves or socks must be at least 50 mm above the lower edge of that part of the garment



*Figure 15. Protective clothing of high visibility*

Background material colors and combined material properties can be:

- fluorescent yellow
- fluorescent orange-red
- fluorescent red

Reflective materials are classified two levels:

Level 1 - lower level of retro-reflexivity

Level 2 - a higher level of retro-reflexivity



*Figure 16. An example of a lower and higher level of material visibility*

Considering the importance of color for high visibility clothing, specific requirements for color durability to rubbing, washing, dry cleaning, bleaching and ironing must be respected.

## **2.7. Protective clothing for chemicals**

Clothes used in chemical hazards are produced in the form of protection against harmful chemicals in gaseous, liquid and solid state. Depending on the purpose and environment in which it is used, protective clothing must be made of high quality materials that will fully ensure the worker's work. Polyamide and polyester, as well as other materials that have a high resistance to the performance of chemicals, are used today to make these garments.

The task of protective clothing is to completely seal the body and isolate it from external harmful effects.

According to the durability of use, chemical protective clothing is divided into:

- continuous use clothing
- wear limited use
- disposable clothing

Protective clothing for permanent use is made of mechanical resistant materials that allow for frequent cleaning and maintenance, where the composition of the material and the impermeability must remain unchanged.

Protective clothing for limited use is made of materials that are mechanically quicker to wear out of permanent ones, and the lifetime is limited in terms of maintenance.

Protective disposable clothing is made of one-layer materials that have the protection properties in certain work operations after which the clothes are no longer for use. This type of clothing is most commonly used in the food, pharmaceutical and chemical industries where clothing satisfies a sufficiently high level of protection for certain work, which is why it is not profitable to clean the clothes and to examine the impermeability of the material, but the clothes are destroyed.



*Figure 17. Protective clothing for chemical protection*

**a - suit for protection against chemicals in the liquid state**

b - suit for protection against solid chemical particles

c - spray protection suit

## 7. CONCLUSION

The protection of workers at the workplace is carried out by legal, administrative, organizational, technical, personal and medical measures. The obligation of employers to the legal regulation of insurance of workers is to provide workers with protective equipment. Also, the worker is obliged to use the prescribed protective equipment. Any protective suit that has been delivered and received must be proof that the product has been tested, that it meets the relevant regulations and standards. All protective clothing for permanent use should be regularly cleaned in accordance with the manufacturer's instructions and recommendations, as well as dispose of clothing in the appropriate place. If it is a disposable clothing, after use it is necessary to remove it appropriately. Protective clothing with its specific properties protects the body from possible injuries, combining active and passive safety features.



## 8. LITERATURE

- [1] [https://hr.wikipedia.org/wiki/Osobna\\_zastitna\\_sredstva#Zastitna\\_oprema](https://hr.wikipedia.org/wiki/Osobna_zastitna_sredstva#Zastitna_oprema)
- [2] <http://www.segedinac.vtsns.edu.rs/vt1.pdf>
- [3] [http://www.inex-zastita.co.rs/download/katalozi/zastita od visokih temperatura inex-zastita\\_1535\\_2326.pdf](http://www.inex-zastita.co.rs/download/katalozi/zastita_od_visokih_temperatura_inex-zastita_1535_2326.pdf)
- [4] [https://www.paragraf.rs/propisi\\_download/pravilnik\\_o\\_preventivnim\\_merama\\_za\\_bezbedan\\_i\\_zdrav\\_rad\\_pri\\_koriscenju\\_sredstava\\_i\\_opreme\\_za\\_licnu\\_zastitu\\_na\\_radu.pdf](https://www.paragraf.rs/propisi_download/pravilnik_o_preventivnim_merama_za_bezbedan_i_zdrav_rad_pri_koriscenju_sredstava_i_opreme_za_licnu_zastitu_na_radu.pdf)
- [5] [http://www.airpoint.rs/pdf/kcp\\_oprema\\_za\\_licnu\\_zastitu.pdf](http://www.airpoint.rs/pdf/kcp_oprema_za_licnu_zastitu.pdf)
- [6] [https://www.researchgate.net/publication/278814097\\_A\\_Technical\\_Overview\\_on\\_Protective\\_Clothing\\_against\\_Chemical\\_Hazards](https://www.researchgate.net/publication/278814097_A_Technical_Overview_on_Protective_Clothing_against_Chemical_Hazards)
- [7] <https://www.labour.gov.hk/eng/public/os/D/PPE.pdf>

## IMPACT OF BODY PROPORTIONS AND GARMENT SIZING SYSTEM ON THE MANUFACTURE OF FASHION WEAR

**Darko Ujević, Blaženka Brlobašić Šajatović, Ksenija Doležal**  
University of Zagreb Faculty of Textile Technology  
[darko.ujevic@ttf.hr](mailto:darko.ujevic@ttf.hr), [blazenka.brlobasic@ttf.hr](mailto:blazenka.brlobasic@ttf.hr), [ksenija.dolezal@ttf.hr](mailto:ksenija.dolezal@ttf.hr)

### ABSTRACT

*Since people differ in height and body development, there is a need for its comprehensive research. To make garment patterns, it is necessary to examine a large number of proportions of the human body and to establish a clothing sizing system. The paper emphasizes the importance of developing and improving the clothing sizing system and the results of a comprehensive anthropometric research conducted in the Republic of Croatia.*

**Keywords:** *clothing sizes, anthropometry, clothing manufacture, body dimensions*

### 1. INTRODUCTION

Confident and conscious consumers encourage the supply and manufacture of textiles and clothing by their choice and demand. Designers are the ones on whom garment fit depends, and constructors and modelers of clothing need to harmonize their work on designing a collection that is based on fashion trends and adapted to body constitutions and statures in accordance with garment sizes. However, many questions are raised: Does the garment fit the customer's body, his/her measurements, above all the body circumference in relation to body height? Does the customer feel comfortable in the offered and selected garment? The designers and constructors of clothing should answer these questions, and if possible it is necessary to carry out a comprehensive research of the population for who such products are meant.

### 2. PROPORTIONS AND PHYSIQUE

Determination of body proportion is carried out largely on the basis of anatomy, the branch of science concerned with the shape and arrangement of individual parts of the human body, and body proportions depend on the relation between the skeleton and muscles. In order to classify various garment sizes more easily, they should be divided according to human stature and physique (constitution). The human body should be observed on the basis of the simplest division, namely body height and transverse plane. Human growth is an increase in body mass in height and width, which is conditioned by physiological and psychological factors. The height of the human body is determined by the skeleton, which in some people is more developed, and in others it is less developed, so some people are taller and others are shorter. Because of different statures – different heights – according to the measurement system of the human body people can be classified into two basic groups: people of short and people of normal stature. Normal stature is subdivided into persons of short, medium and tall stature.

Apart from short, normal and tall stature, there is a small group of people with extremely tall stature, Fig. 1. [1].



*Figure 1 Comparison of the body composition between man and woman of tall, normal and short stature [1]*

The appearance of the human body changes over time, starting with infants, adolescents, middle-aged and old aged people, whereby body proportions, appearance and posture also change. Many scientists claim that it happens because of diet and way of life which constantly change. Children's proportions differ from the proportions of adults. In infants, the head occupies  $\frac{1}{4}$  of body length. Head circumference is larger than chest circumference. The arms and legs are very short. The width of the shoulders is equal to the length of the face, the distance between the shoulders and the elbows, when the arm is stretched, is equal to the distance of the long finger of the hand and bent elbow, the distance between the pubis and the knee center, the distance between the knee joints and the joints of the foot. By three years of age a child reaches twice the body height compared to the time of birth, amounting to about 90 cm. At the age of about of 12 a child grows up to  $\frac{3}{4}$  of the height of an adult man. Width relationships (chest, waist and hip girths) show certain deviations. Chest circumference in childhood is slightly narrower in comparison to waist circumference, which changes by growing over the years. Until the age of 20 years man is fully grown up, and the head is attributable to  $\frac{1}{8}$  of body height. By reaching the final human height, each of these distances doubles its length, except for the length of the face [2].

Over time, the shape of the human body has changed significantly. Author Workman argues that aging contributes to perceived changes in body shape and size more than any other single factor, such as improved diet and longer life expectancy.

Interest in garment sizing will increase because it is expected that the number of older customers will be doubled by 2030. This represents a market challenge for the clothing industry because poor garment sizing is the main reason for return of products and lowering prices, resulting in significant losses.

Over the years in different parts of the world clothing sizing systems have been created, which in most cases vary with respect to the parameters on which they are based, the intervals of component sizes and perhaps especially in labelling techniques. They can vary considerably from one garment type to another one, but also within the same type of clothing; not just from country to country, but within the same country and even within the same store. Many examples of discrepancies can be identified in garment sizing and varieties, but they can also be encountered by personal random visits to stores.

Articles of clothing that originate from different countries, or from different manufacturers in the same country, can be found hanging next to each other on hangers and have different shapes of size labels.

Those with insignificant (for the public) code numbers can be criticized as such, but the others, who at first glance have significant numbers, e.g. „size 100” , leave a potential buyer (and often a seller) in doubt to which dimension it applies [3].

Labels are changed very much; they can be totally or partially encoded, they can refer to garment size without denoting anything about the body size for size 10 or which size is involved. In the case of women’s outerwear, the size may be related to hip size if produced in the UK or to bust size if produced in France or Germany.

The clothing sizing systems mentioned above and for a number of reasons must therefore be updated from time to time to ensure the correct fit of ready-to-wear clothing and footwear.

In recent years, many countries have started using surveys for the purpose of clothing sizing. Table 1 shows the most important size designations [4,5].

Table 1. Overview of standards for size designation in different countries of Europe and the world

Country	Last updating	National standard	Body measurements			
			Men	Women	Children	Infants
Australia	1997	AS 1182		√		√
Canada	1992	CGSB 49.5-M85-CAN/CGSB			√	√
China	1997	CSIC GB/T 1335.1-97	√	√		√
France	1987	NF G03-008	√	√		√
Germany	2002	DIN EN 13402		√		
Hungary	1986	MSZ 6100/1	√	√		
Japan	2001	JIS L4001 to 4005	√	√		√
Korea	1990	KS K0050 to 0052	√	√		√
New Zealand	1973	NZS 8774.5	√	√		
Philippines	1988	BPS 114		√	√	√
Singapore	1982	PSB SS262 part 1-6	√	√	√	√
Slovakia	1981	SUTN STN 80 5023	√	√	√	
South Africa	1982	SABS 039	√			√
Spain	1974	UNE-40229 to 31	√	√		√
Great Britain	1989	BSI BS 3666	√	√		√
USA	2001	ASTM D 4910	√	√		√
ISO	1991	ISO/TR 10652	√	√		√

### 3. STANDARDIZATION OF SIZING SYSTEMS AND ISO STANDARDS

Since sizing practices vary from country to country, in 1968 the first official approach to the International Organization for Standardization (ISO) for the purpose of clothing sizing was originated as it was in the interest of the professional and other public to create an international system. Sweden suggested a discussion on the terminology and definitions, dimensions and tolerances and selection of sizes at the international level.

The ISO then set up a new Technical Committee TC 133 entitled 'Sizing Systems and Designations for Clothes'. It consisted of member countries that actively participated in the work, and the committee held its first formal meeting in 1970.

After lengthy discussions and plenty of suggestions, the term 'Mondoform' was agreed on as a suitable title to cover size designation implementation work.

To label clothing sizes, a pictogram with indicated body measurements representing garment size is used. At the completion of the 5th meeting in 1979 members submitted documents relating to secondary body dimensions, their definitions and measurement methods.

This eventually resulted in the publication of ISO 8559 'Garment Construction and Anthropometric Surveys - Body Dimension' which is used as an international standard for all types of size survey.

The ISO system suggested describing garment sizes in a "pictogram" in which an illustration of key dimensions is shown.

These size-labelling systems let consumers select their garment sizes by comparing their measured body size with that labeled on the garment. It is expected that consumers will be able to find their correct garment size easily without trying on too many garments. It is also expected that the system will reduce the costs of manufacturers and retailers which are associated with the frequent returns of ordered garments and damaged garments. ISO clothing designation systems are based on body measurements, not on garment measurements. The selection of garment measurements is entrusted to the designer, constructor and manufacturer who deal with styles, patterns and other fashion elements [6].

Garment size designation shall contain the marked body measurements of the person for whom the garment is intended. Size designation according to the ISO systems or the Mondoform system includes 1 to 3 marked body measurements that are indicated on the pictogram, or the designation is indicated by the numerical values of the marked body measurements together with the description, e.g.: 'Chest Size 96', 'Body Height 176' etc.

The pictogram symbolically represents the silhouette of a human body where the positions and values of the marked body measurements can be displayed. To display these measurements, the standard pictogram is applied, Figures 3 and 4. [7-10].

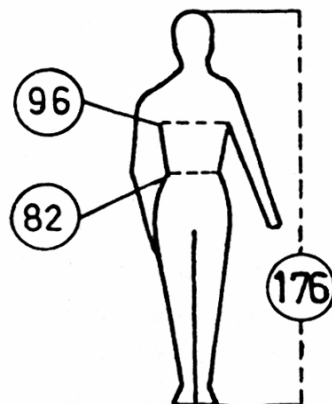

Figure 3 ISO garment size designation of men's jacket

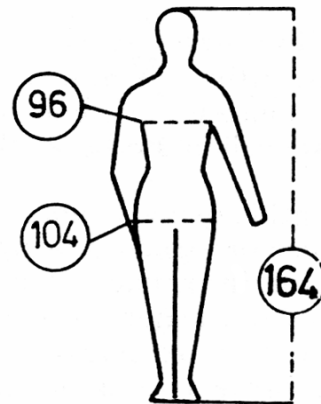

Figure 4 ISO garment size designation of women's dress

### **3.1. Standards and fashion wear**

The development objective of textile technology is to cut high manufacturing costs, to reduce environmental pollution, energy and water consumption and to maintain high creativity and production flexibility. The next important conditions are to ensure delivery times and high product quality required by high standard of living today.

The market has a major impact on the development of the textile and garment industry, with demands on quality and fashion trends in terms of wear comfort, as well as an increase in living standards and high population growth.

Also, the widespread use of textiles and artificial leather causes a rapid increase in demand for textiles. By wearing versatile clothing consumers want to emphasize their identity. The supply, therefore, must be tailored to the desires of individual consumer groups, which is a complex process that can be successfully implemented through marketing.

The production of textiles, especially of technical textiles, is constantly growing, but quality requirements too. This results in the general progress of the textile industry to which new products, new technological processes, innovations in the construction of textile facilities and increase in operating speeds of machines, requiring the application of electronic or computer-aided process control, make an enormous contribution. This reduces the number and extent of errors, increases the working speed and production safety. The application of computer technology can improve grading, making patterns and optimize inventory stock. This ensures a high degree of automation and obtaining a uniform and high quality product. Science becomes one of the main pillars of progress; without scientific research, we cannot imagine modern industrial progress.

Apart from scientific research to improve technology, market research and monitoring of requirements on product quality are necessary. It is required that quality is defined and the way of its evaluation and presentation is determined. International quality standards are established to be met if success on the international market is strived for. Also, manufacturers whose products will meet certain conditions shall have the right to label their products with a unique European mark of conformity CE, which will surely provide better placement on the market. It is necessary to ensure the monitoring of professional and patent literature, the monitoring of new regulations and the introduction of new regulations, procedures and testing, as well as the adoption of new quality regulations. Research has shown that the need for qualified staff will grow, so education should be given full attention, both of mid-level staff and of graduate engineers and future scientists. With constant changes in technology advancements, amendments and supplements in quality regulations are necessary, which is the reason why much attention needs to be paid to continuing further professional staff training [11].

### **3.2. Proposal of the new Croatian garment sizing system and size designation – Croatian Technical Report**

Croatian Technical Report HRI 1148:2012 refers to anthropometric measurements and sizes used in the industry of different types of clothing and footwear.

The purpose of this report is:

1. to provide a thorough understanding of the classification of clothing according to size in order to improve the suitability and fit in the Republic of Croatia,
2. to optimize the number of garment and footwear sizes especially designed for the Croatian population,
3. to facilitate the technical cooperation between manufacturers, sellers and customers as end consumers.

As the basic starting point for a new method of designating clothing and footwear size in the Republic of Croatia the system and method of designation specified in European standards 13402-1, 13402-2 and 13402-3 have been accepted.

According to EN there are eight male body types that are based on the difference between chest girth and waist girth.

Based on the measurements carried out within the framework of the Croatian Anthropometric System project, it has been established that there is a part of the male population in the Republic of Croatia whose waist girth in relation to chest girth is greater than the greatest one defined according to EN 14302-3. Therefore, a new ninth male body type was proposed within the new Croatian standards for clothing and footwear, Table 2. [12].

Table 2: Male body types

	<b>Body type</b>	<b>Type definition</b>	<b>Waist girth – Chest girth</b>
1	Type A – very slim	Difference -20	From -22 to -18
2	Type B – slim	Difference -16	From -18 to -14
3	Type C – normal	Difference -12	From -14 to -10
4	Type D – sturdy	Difference -8	From -10 to -6
5	Type E – sturdier	Difference -4	From -6 to -2
6	Type F - corpulent	Difference -0	From -2 to +2
7	Type G – paunchy	Difference +4	From +2 to +6
8	Type H – markedly paunchy	Difference +8	From +6 to +10
9	Type I – very paunchy	Difference +12	From+ 10 to + 14

By analyzing the data of anthropometric measurements within STIRP (compound technological research project) under HAS (Croatian Anthropometric System) it was found that a part of the female population of the Republic of Croatia has a larger or smaller hip girth than defined by EN 14302-3. This is the reason why two new female body types are proposed (**a0** and **e0**).

According to the difference in bust girth and hip girth seven female body types were determined:

1. Type **a0** – markedly narrow hips
2. Type A – very narrow hips
3. Type B – narrow hips
4. Type C – normal hips
5. Type D – wide hips
6. Type E – very wide hips and
7. Type **e0** – markedly wide hips

Table 3: Measurements of hip girths in cm according to standard for women

Hips type <b>A0</b> (markedly narrow hips)														
<b>Ob</b>	72	76	80	84	88	92	96	100	104	108	112	112	117	122
Hips type <b>A</b> (very narrow hips )														
<b>Ob</b>	68	72	76	80	84	88	92	96	100	104	110	116	122	128
Hips type <b>B</b> (narrow hips)														
<b>Ob</b>	72	76	80	84	88	92	96	100	104	108	114	120	126	132
Hips type <b>C</b> (normal hips)														
<b>Ob</b>	76	80	84	88	92	96	100	104	108	112	118	124	130	136
Hips type <b>D</b> (wide hips)														
<b>Ob</b>	80	84	88	92	96	100	104	108	112	116	122	128	134	140
Hips type <b>E</b> (very wide hips)														
<b>Ob</b>	84	88	92	96	100	104	108	112	116	120	128	132	138	144
Hips type <b>E0</b> (markedly wide hips)														
<b>Ob</b>	88	92	96	100	104	108	112	116	120	124	130	136	142	148

#### 4. CREATION OF COLLECTION OF FASHION WEAR

Fashion clothing is made for the spring-summer or fall-winter collection and is presented at trade fairs, shows and other events where sales contracts are concluded for the next season. For each model the number of pieces, garment sizes, designs, prices and delivery times are determined. Based on the collection sold in such a way, all the activities related to the production process are planned for the next season.

Designing the collection involves performing all the activities of construction preparation, collecting ideas, creating and designing garments, crown construction, model description, standardizing new chopper parts, making crowns and determining consumables.

Creation of collections involves carrying out all the activities related to construction preparation: collection of ideas, creating and designing garments, construction of patterns, model description, and standardization of new cutting parts, marker making and determining the material consumption.

The order of the activities in creating a collection related to the work of designers and modelers in the construction preparation are:

- defining the collection structure
- making garment patterns and samples for model prototypes
- making garment patterns and samples for all models and
- creation of supporting documentation.

Based on the research of market needs, it is necessary to determine the collection structure according to model types and their associated materials. It is necessary to take account of the production program of the company. Afterwards material samples are obtained, so-called coupons, which are necessary for creating a collection and garment pattern making. Patterns are usually made only for some characteristic models, which will afterwards serve as a basis for making patterns of similar garments.



The patterns made in such a way are used to develop model prototypes, the purpose of which is to check the pattern and to identify possible shortcomings of models. If necessary, some models can be recreated after appropriate modifications. Models are made in the manner and on the machines that match the future serial production, regardless of the fact that every sample is usually made by one person or a smaller group. After the patterns have been verified in such a way, all other models foreseen for this collection are made. The next step is to analyze all the models and, if necessary, to make any possible changes. At the same time, material components with appropriate consumption, measurement rules, manufacturing time, and all other data necessary to determine the selling price of the model are determined. Depending on the organization of the company, the manner and the number of presentations of the collection, it is necessary to make a number of samples of identical models.

The fashion industry employs a large number of employees and absorbs approximately 1/16 of the total consumption in the world. However, regardless of the tremendously rapid development of techniques and technologies, people still relatively do a lot of work in fashion. Fashion as a factor has a strong impact on overall business results, while manufacturing and turnover of fashion products are a big business, with marketing being crucial in achieving these goals. To make changes that are necessary in fashion, the industry must continually create new products. Used in another sense, the term fashion means to construct, create or make. Fashion, therefore, also implies a strong creative and designer component. Design skills are necessary, and they are observable on all products from a made-to-measure suit to a complex detail on knitwear. According to some authors, fashion clothing design can be seen as art for itself, though such an attitude is most common in France and Italy.

Most of the sold items do not fall into that category, but the inspiration for the design of many fashion products often comes from art. A new technology is widely introduced in all industrial areas in order to improve the quality of life and to increase the speed and quality of production. In the field of fashion and clothing, there have been many inventions. Some of them had only modest effects on the market, while others were revolutionary. Technological changes affect both manufacturing methods and consumer choice. CAD / CAM systems (computer construction and garment manufacturing systems) also had a tremendous impact on the manufacturing sector, while the EPOS system (Electronic Point of Sale – it processes calculations included in sales) changed the manner of control over activities for retailers. On the one hand, technology brings many benefits to manufacturers, but on the other hand, it is a constant problem for marketing management to keep pace with changes. Technological changes have affected the everyday life of consumers. The use of audio-visual technologies has led to the development of the so-called TV fashion magazines, such as the CLOTHES SHOW, resulting in the fact that videos of fashion shows are now regular items. In this way consumers are better than ever informed about fashion trends.

Textile care technology – linen washing, drying and ironing machines – facilitates textile care and enables the expansion of fabric selection, etc. Technology development also means an even stronger international competition.

Markers can be sent directly (forwarded to manufacturers) in the Far East, where they can be made for much less money than in Europe and samples can be returned in almost the same time period that shipment needs to arrive from one end to the other end of a country [ 13,14].

## 5. CONCLUSION

Within a certain period of time, a different value or approach is attached to fashion.

Fashion has been the benchmark for determining psychological, psychoanalytical and economic motivation of humanity and has always represented one of the important social and economic phenomena in the contemporary world.

The relationship between the body and the garment is a very significant and valuable indicator for reading all the multi-layered factors that manage the changes in dressing but at the same time the relationship between an individual and his social environment. In production as well as in use anthropometry plays an important role in determining measurements, proportions, statures, or real body shapes that form the basis to be followed by all fashion innovations.

This paper was produced in the framework of the Project entitled Anthropometric Measurements for Woven and Nonwoven Clothing - Croatian-Chinese bilateral project under the leadership of the Croatian project leader Prof. Darko Ujević, PhD, for the period 2017 - 2019.

## REFERENCES

- [1] Vinković M., Šabarić I.: Razvoj potrošačke svijesti i utjecaj na istraživanje veličina u tehnologiji i dizajnu odjeće, D. Ujević (Ur.), Hrvatski antropometrijski sustav – Podloga za nove Hrvatske norme za veličiu odjeće i obuće, Tekstilno –tehnološki fakultet Sveučilište u Zagrebu, Zagreb, 2006.
- [2] Ujević, D., Rogale, D., Hrastinski, M.: Tehnike konstruiranja i modeliranja odjeće, Treće dopunjeno i prošireno izdanje, Tekstilno-tehnološki fakultet Sveučilišta u Zagrebu, Zrinski d.d. Čakovec, 2010.
- [3] Ujević D. i sur.: Osnove antropometrije ljudskog tijela i osvrt na razvoj sustava određivanja veličina za odjeću, D.Ujević (Ur.), Hrvatski antropometrijski sustav – Podloga za nove Hrvatske norme za veličiu odjeće i obuće, Tekstilno –tehnološki fakultet Sveučilište u Zagrebu, Zagreb, 2006.
- [4] French, G. E.: International sizing, Clothing Inst. Journal, 1975,23, 155 – 162
- [5] Kemsley, R.: Women's Measurements and Size - A Study Sponsored by the Joint Clothing Council Limited, London, HMSO, 1957.
- [6] Kouchi, M., Mochimaru, M.: Japanese Body Dimensions Data 1997-1998, English version, Digital Human Laboratory, National Institute of Advanced Industrial Science and Technology, 2002.
- [7] Desnartean, K.: „Let the fit revolution begin”, URL:www.findarticles.com,2000.
- [8] Ujević, D., Szivovicza, L., Dimec, M.: Prikaz istraživanja i usporedbe sustava odjevnih veličina, Tekstil 52 (2003.) 12, 611–620
- [9] Fan, J., Yu, W., Hunter, L.: Clothing appearance and fit: Science and Tehnology, The Textile Institute, 2004., England
- [10] French, G. E.: International sizing, Clothing Institute Journal, 1975, 23, 155-162
- [11] Lazibat T.: Općenito o normama i normizaciji, D.Ujević (Ur.), Hrvatski antropometrijski sustav – stanje, realizacija, primjena - Podloga za nove hrvatske norme za veličinu odjeće i obuće, Tekstilno–tehnološki fakultet Sveučilišta u Zagrebu, Zagreb, 2006.,str. 183-197.
- [12] D. Ujević i sur.: Antropometrijski sustav – Mjerenje tijela i označavanje veličina odjeće i obuće, Anthropometric System – Measuring and Size Designation of Clothes and Footwear, Hrvatski tehnički izvještaj, HRI 1148:2012, HZN, veljača 2012., ICS 01.040.61:61.020
- [13] Ujević, D., Szivovicza L., Dimec M.: Prikaz istraživanja i usporedbe sustava odjevnih veličina, Tekstil 52 (2003.) 12, str. 611-620.
- [14] Ujević D., Brlobašić Šajatović B., T.Lazibat: Konstrukcija, modeliranje i modno odijevanje, Konstrukcija i modno odijevanje s osvrtom na suvremenu maloprodaju, Tekstilno – tehnološki fakultet Sveučilišta u Zagrebu, Ekonomski fakultet Sveučilišta u Zagrebu, Zagreb, 2018. , ISBN 978-953-7105-68-6

## ANALYSIS OF THE TECHNOLOGICAL PROCESS OF THE PRODUCTION OF WOMEN'S UPPER CLOTHES ON THE EXAMPLE OF GERMAN COMPANY "PIRIN TEX"

**Boryana Vatova, M. Pavlovic, A. Milosavljevic ,D. Joksimovic, V. Petrovic**  
 New Bulgarian University - "Montevideo" 21, 1618 g.k. Ovcha kupel 2, Sofia, Bulgaria  
 Technical Faculty "Mihajlo Pupin", Zrenjanin,  
 Đure Đakovića bb, 23000 Zrenjanin  
 e-mail: [marica.pavlovic4@gmail.com](mailto:marica.pavlovic4@gmail.com)

### ABSTRACT

*In this paper you will see a brief overview of their region, their company, production program and activities, from its creation, 25 years ago, to the present. This picturesque city, located in the valley of the Mesta River, is surrounded by the mountains of Pirin, from the west, and by Rhodope from the east. Today, the population of the town of Goce Delchev is about 25,000, and together with the population of surrounding villages the region reaches about 73,000 inhabitants.*

**Keywords:** Germany, company, women, clothes, Bulgaria, Pirin- Tex

### 1. INTRODUCTION

The owner and founder of Pirin Tex is Mr. Bertram Rollman. He is the Managin Director and head of clothing production. His responsibilities do not stop there; he is also responsible for purchasing, quality assurance, cost management, CSR and environmental purchasing, energy efficiency and product development. Mayor of Goce Delčev urged to launch a pilot production project together with the state. Pirelli AD is a joint venture partner. The first shareholder is the German company "Rollmann & Partner, Fashion Management" GmbH. It is a company which is 50% owned by the Rollman family, which has been actively involved in the fashion industry for 70 years.

As a result of the successful implementation of the pilot project, Mr. Rolman has initiated the shareholders to invest in the company's advancement. With the rapid growth processes of the company, he continued his job in Goce Delchev in an attempt to make the highest quality clothing item with the latest machines and sewing machines and to face the competition of Romania, Serbia, Ukraine and China.

#### 1.1 Clothing Assortment



Figure 1. Assortment of women's wardrobe

In the range of products women's clothes include:

- Women's jackets
- Women's coats
- Women's blazers
- Women's waistcoat
- Women's shirts
- Women's skirt suits
- Women's skirts
- Women's pants
- Women's tracksuits



Figure 2. Assortment of man's wardrobe

The range of men's clothing products includes:

- Men's suits
- Men's coats
- Men's vests
- Men's shirts
- Men's blazers
- Men's jackets
- Men's trousers
- Men's trousers
- Men's shorts

## 1.2. About the company

The company is organized through the following working units:

- Management
- Purchasing department
- Warehouse material
- Production preparation
- Sewing samples
- 6 dressmakers with about 180 executives
- 12 production lines with about 1500 workers
- Product quality control department
- Warehouse of finished goods
- Logistics and transport services
- Maintenance service

### 1.2.1. Daily production capacity:

Men's clothing:

- Clothes - 4 lines - 1200 pieces
- Trousers - 3 lines - 1200 pieces
- Vests - 1 line - 100 pieces

Women's clothing:

- Clothes - 2 lines - 70 pieces
- Pants - 1 line - 250 pieces
- Blouses - 1 line - 600 piece

When it comes to the development of activities in Pirin Tex, the design patterns are based on sketches of stylists, prototypes and commercial samples. Technical readiness for serial production is at a high level, rapid development of technical specifications for products is carried out.

There is a good adjustment of the price to the rate of costs, material and workforce calculation, confection-production of finished products, work in semi-fashion and fashion. For the classification and optimization of cuts, there is the support of the production process by "Lektre" and ASIST system.

Company "Pirin Tex" has its own washing of the final products (enamel clothes washing), as well as its own laboratory within the company for the development of coloring lines and dyeing machines for final products (dyeing of clothing items). They also have their own labels printing office, maintenance labels and other production labels.

Furthermore, we can say that within the production equipment they owe specialized production equipment and vehicles for the fashion industry. Trading with semi-machines and semi-equipment as well as recycling is a way to save money, and a positive thinking about preserving the environment. All unused material finishes is sold as the textile waste. [26]

### 1.3. Quality Management (GIQ)

The uncompromised quality of Pirin Tex production is done through constant control-documentation processes in an optimal way, with the results of quality control and their analysis. This is why the company has made its own IT sector, with six developers, who have developed systems for quality management "GIQ", for all companies involved in the production of clothing.



*Figure 3. IT expert's*

The history of production and quality of each product of Pirin Tex is 100% documented through the tracking of the unique bar codes for all processes and controls as part of the working cycle. Normalized workplace and ergonomically optimized controller for documented control, provide 100% quality of each piece. The workplace includes:

- Hanging transport with special lighting and rotary hangers.
- A touchscreen with a barcode scanner

A great potential is provided by the bar code scanner and bar codes attached to each clothing item. In fact, the system of the card is very simple. After each operation, the bar code is loaded, so that the each piece is very well located. It is known where exactly and to which part of the operation a clothing item has come. The duration of an operation is also measured, and the worker's norm itself is calculated in this manner. Another advantage of bar codes is the separation from further production of any type of defective products. The system uses a touch screen, which is linked to the product control. During control, a list of registered damaged products is obtained.

## 2. EXPERIMENTAL PART

In the company "PIRINTEX" from the production program, the following models were selected for analysis:

- Model 01 - women's trench coat
- Model 02 - female jacket

Each process sheet contains all one-phase processes described in the technological order. In addition to the name of the process, the sheet also contains data on the time of production and the means of operation.

Each process sheet consists of complex plans and is divided according to the phases of manufacturing, to the process sheet for:

- Spreading and Cutting Department
- Sewing department
- Finishing

## 2.1. Women's trench coat manufacturing



Figure 4. Women's trench coat



Figure 5. Technical sketch of women's trench coat

### 2.1.1. Description and sketch of the model 01 – women's trench coat

Description of the design of the cut of the women's trench coat:

The coat consists of seven parts (front, back, sleeves and collar). The front part consists of two parts, it has 3 buttons for claspings, and on the front there are two storm pockets. On the side part there are two eyelets, through which a 5 cm wide band is passed. There are no facings on the back.

The collar is with a stand-two-piece collar. Around the collar from the inside was a PSEC?. The coat is with the lining. The sleeve is a raglan sleeve, and it consists of the upper and lower sleeves. The trench coat is 120cm long.

## 2.2. Women's jacket manufacturing



Figure 6. Women's jacket

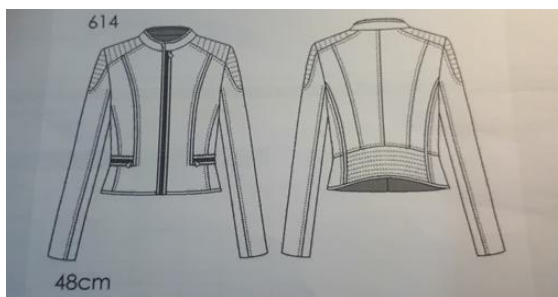











Figure 7. Technical sketch of women's jacket

### 2.2.1. Description of the women's jacket model

The front part consists of 10 parts. On one side there is cutting in the shoulder part made of the leather material, on the side part, on the upper part above the pocket and the lower part that is connected with the strip for the zipper, the pocket has two patches and a zipper closure. The back part consists of 11 parts, the cutting is in the middle, as well as the princess cut divided into two parts and one part at the bottom of the back where the material is leather and shoulders seam, which is also made of leather. Below the shoulder seam there is another cutting down. Sleeve has 4 parts, one is a leather part, which enters the upper sleeve. Collar is Mandarin collar. The edges are reinforced with a decorative band.

### 2.3. Technical Details

Technical details		
Item: Women's coat		Model: m – 01
Type of material	Sample	Raw material composition:
Basic material		50% wool 50% acrylic fiber
Lining		100% vikoza
Sewing thread	Grey 635 	100%polyester
Button		black button
		Sewing label

<b>Item: Women's jacket's</b>		<b>Model: m – 02</b>
<b>Type of material</b>	<b>Sample</b>	<b>Raw material composition:</b>
<b>Basic material</b>		<b>100% Acetat</b>
<b>Lining</b>		<b>100% viskoza</b>
<b>Sewing thread</b>	<b>Black 9833</b> 	<b>100% poyester</b>
<b>Patent</b>		<b>Black patent</b>
<b>Label</b>		<b>Sewing label</b>

**2.4 Total time for the design production – 01 trench coat in seconds**

Spreading and Cutting department	1006s
Spreading and Cutting Department II	257s
Sewing Department	3098s
Finishing	241s
Total:	4541

**2.5. Graphic representation of the production time of the women's trench coat - model 01**

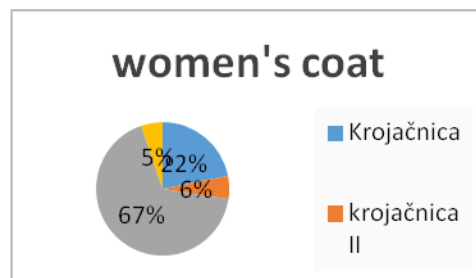

Figure 10. Graphic representation of the production time of the women's trench coat - model 01



## 2.6. Graphic representation of the production time of the women's jacket

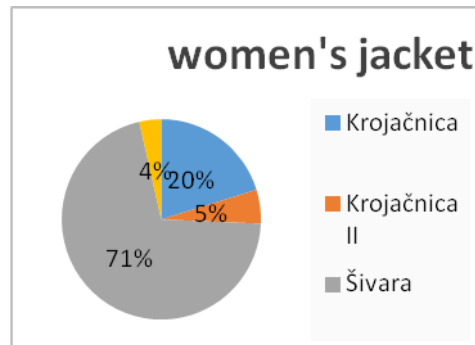

Figure 11. Graphic representation of the production time of the women's trench coat - model 02

<b>Spreading and Cutting Department</b>	<b>187s + 690s</b>
<b>Sewing Department</b>	<b>2420s</b>
<b>Finishing</b>	<b>121s</b>
<b>Total :</b>	<b>3409s</b>

## 3. CONCLUSION

Upoređivanje vremena izrade odabranih modela je sledeća:

MODEL 1: 4541seconds.

MODEL 2: 3409 seconds.

## 4. COMPARISON OF TIME

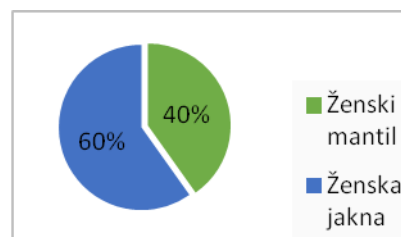

Figure 12. Graphic representation of the compared production time of the selected models

In the analysis of the women's coat on the example of "Pirin-tex" company, the paper emphasizes the work of the original models and models in our direction. This picture represents an example where the original trench coat and the trench coat that I have sewed are clearly compared.



*Figure 13. Compared trench coats*

In the analysis of the women's jacket on the example of "Pirin-tex" company, the paper focuses on the original model.



*Figure 14. Manufactured model*

## 5. CONCLUSION

The history of production and quality of each product of Pirin Tex is 100% documented through the tracking of the unique bar codes for all processes and controls as part of the working cycle. Normalized workplace and ergonomically optimized controller for documented control, provide 100% quality of each piece.

## 6. REFERENCES

- [1] <https://www.pirintex.com/>
- [2] <https://www.rollmannfashion.com/>
- [3] <https://brand.laurel.de/en/>
- [4] 4. Ko, F.K., Nanofiber Technology: Bridging the Gap between Nano and Macro World”, in NATO ASI on Nanoengineered Nanofibrous Materials, 2003, Anatalia, Turkey, Kluwer Academic Publishers

## GEOMETRICAL MODELLING OF PLAIN WEFT KNITTED FABRICS

Vojislav Gligorijevic<sup>1</sup>, Goran Demboski<sup>2</sup>, Radica Nicic<sup>1</sup>, Jovan Stepanovic<sup>1</sup>, Nenad Cirkovic<sup>1</sup>

<sup>1</sup>University of Nis, Faculty of Technology, Leskovac, Serbia

<sup>2</sup>Ss. Cyril and Methodius University in Skopje, Faculty of Technology and Metallurgy,  
Skopje, Macedonia  
e-mail: vojatrik@yahoo.com

### ABSTRACT

*The model of the relationship between the loop, the order of the loop length and the length of the loop in the loop was developed. The coordinate values of the points illustrated were calculated which define the central axis of yarn using the spline curves in Abaqus/CAE. Abaqus/CAE calculates the shape of the curve using a cubic spline fit between all points along the spline; In addition, the first and second derivatives of the spline are continuous. The 3D models of plain weft knit fabrics can be generated by sweeping the circular cross section of the yarn along the central axis of the yarn. Yarns were assumed to be incompressible in nature.*

*Knitted fabrics have a good stretch property that offer better conformability and avoid excessive pressure between the garment and body. Many researchers have analyzed the geometrical pattern of knitted fabrics. In 1926 Chamberlain presented a two dimensional loop structure of plain knitted fabric. He proposed that the theoretically correct fabric, in which GH represent the distance between the centers of two loops, GKH represent the equilateral triangle and KJ bisect the equilateral triangle. In Chamberlain's model there is no consideration of loop in third dimension in order to produce the fabric with maximum cover factor, but it is only possible when GH is the distance between the loops in horizontal direction and KJ is the correct length between the loops in longitudinal direction. so the length of loop can not be predicted with high accuracy. In 1947 Peirce developed a geometric model of plain weft knit fabric on the assumption that the loop formed from the circular arc and straight line and the yarn central axis follows a path on the surface of cylinder following the direction of a course. In order to develop the relationship of stitch length in terms of yarn diameter, wales and course spacing.*

**Key words:** loop, loop length in loop, loop geometry, geometric loop model

### 1. INTRODUCTION

Knitted fabrics have a good stretch property which offer better conformability and avoid excessive pressure between the garment and body [1]. Many researchers analysed the geometrical model of knitted fabrics. In 1926 Chamberlain [2] presented a two dimensional loop structure of plain knitted fabric. He proposed that the theoretically correct fabric as shown in Figure 1, in which GH represent the distance between the centres of two loops, GKH represent the equilateral triangle and KJ bisect the equilateral triangle. In order to produce the fabric with maximum cover factor with minimum weight it's only possible when GH is the distance between the loops in horizontal direction and KJ is the correct length between the loops in longitudinal direction.

The minimum area of intersection obtained when:

$$JK = \frac{\sqrt{3}}{2} \cdot GH$$

1

The relationship between course and wale in the fabric is expressed:

$$\frac{\text{Course}}{\text{Wales}} = \frac{2}{\sqrt{3}} \quad 2$$

Diameter and stitch length of the yarn can be calculated by the following equations [2].

$$\text{Diameter of yarn } (d) = \frac{\text{Width of wale}}{4} \quad 3$$

$$\text{stitch length of yarn } (l) = \pi \cdot \text{mean diameter of loop circle} \\ \text{and combined length of side loop } (R \text{ and } T) \quad 4$$

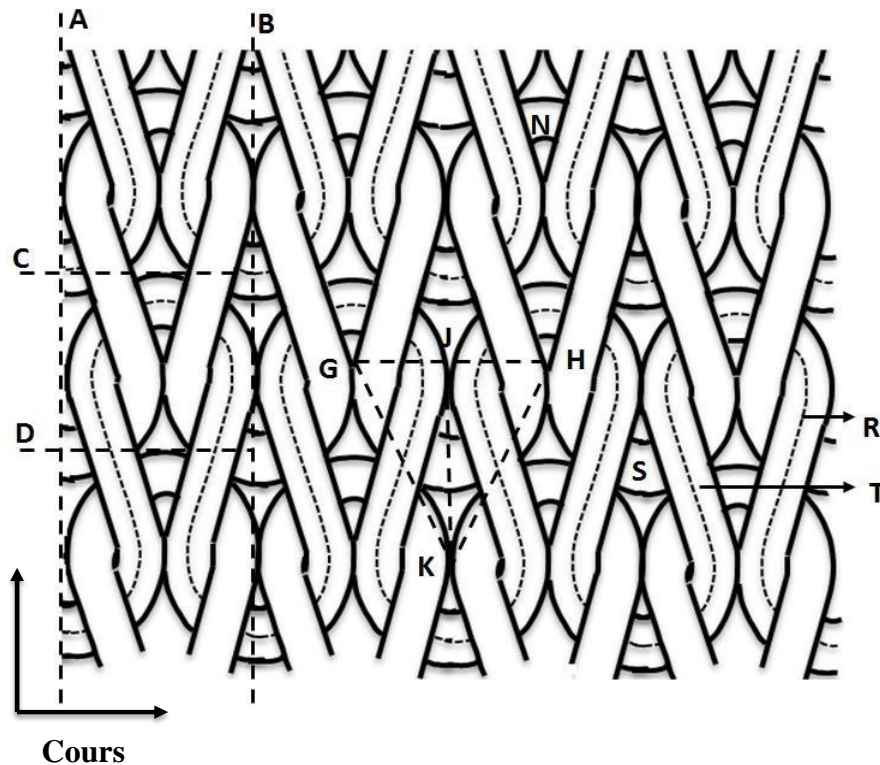

Figure 1: Chamberlain's jammed plain knitted loop

$$\text{stitch length of yarn } (l) = \frac{3 \cdot \pi \cdot w}{4} + 2 \sqrt{\left(\frac{w}{4}\right)^2 + \left(\frac{w \cdot \sqrt{3}}{2}\right)^2} \quad 5$$

$$\text{stitch length of yarn } (l) = \frac{3 \cdot \pi \cdot w}{4} + \frac{w \cdot \sqrt{13}}{2} \quad 6$$

$$\text{stitch length of yarn } (l) = \frac{w \cdot (3 \cdot \pi \cdot 2 \cdot \sqrt{13})}{4} \quad 7$$

where  $w$  is the wale spacing.

In Chamberlain's model there was no consideration of loop in third dimension so the length of loop cannot be predicted with high accuracy. In 1947 Peirce [3] developed geometrical model of plain weft knitted fabric on the assumption that the loop composed of circular arc and straight line and the yarn central axis follows a path on the surface of cylinder following the direction of a course.

In order to develop the relationship of stitch length in terms of yarn diameter, wales and course spacing he considered the flat structure of plain weft knitted fabric as shown in Figure 2. In his compact planned structure the course ( $p'$ ) and wales ( $w$ ) spacing can be calculated by Equation 8 & 9 respectively,

$$p' = \sqrt{(4 \cdot d)^2 - (2 \cdot d)^2} = 3.4643 \cdot d \quad 8$$

$$w = 4 \cdot d \quad 9$$

Stitch length of loop can be calculated by the following equations.

$$\frac{l}{4} = 3 \cdot d \cdot (\pi - \theta) + 2 \cdot d \cdot \sin(\theta - \psi) \quad 10$$

$\theta$  and  $\psi$  as shown in Figure 2 can be calculated by the following expressions:

$$\psi = \sin^{-1} \frac{1}{2} = 30^\circ = 0.5236 \text{ radian}$$

$$\theta - \psi = \sin^{-1} \frac{1.5}{2} = 41^\circ 24.58' = 0.7228 \text{ radian}$$

$$\theta = 1.2464 = 71^\circ 24.6'$$

Hence stitch length become:  $\frac{l}{4} = 2.8428 \cdot d + 1.3229 \cdot d = 4.1657 \cdot r$ , stitch length  $l = 16.6628 \cdot d$ .

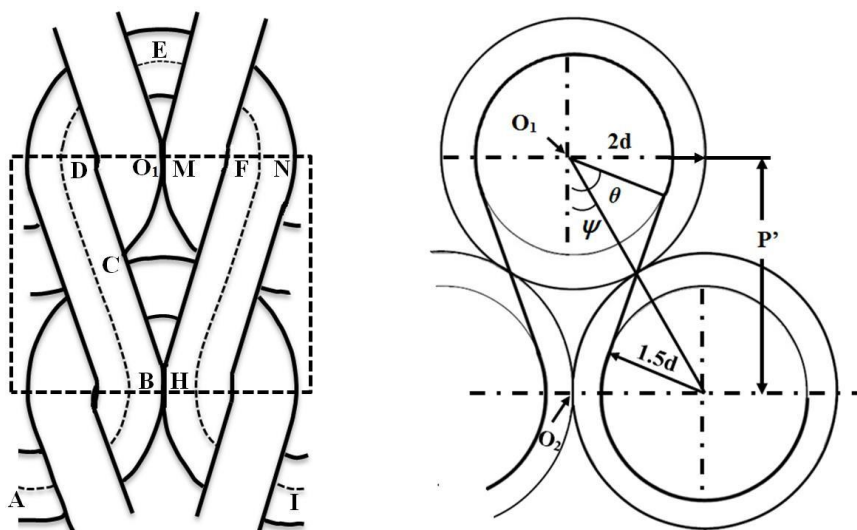

Figure 2: Planed structure of Peirce's loop

In all the above equations there was no consideration of the bending effect of yarn. In order to include this effect he assumed that these loops laid on the cylinder which gives three dimensional effects to the knitted loop. He found that radius of curvature  $R$  was only satisfied in order to provide space for interlocking when it equals to 4.172 times the diameter of yarn as shown in Figure 3.

The wales spacing is not effected in three dimensional loop structure but course spacing as it was observed by him in plane of the cloth is:

$$p = 3.364 \cdot d \quad 11$$

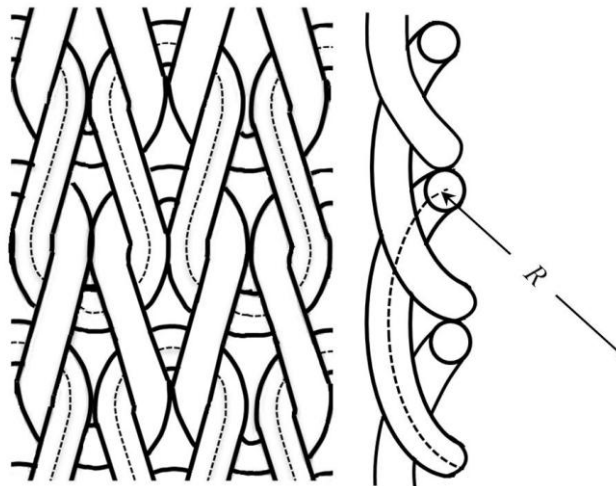

Figure 3: 3D dimensional Peirce's loop structure of plain weft knitted fabric

He also developed a relationship of wales spacing, course spacing and stitch length for open structure plain weft knitted fabric as shown in Equation 12, 13 and 14 respectively.

Peirce suggested that more open structures than the one he consider could be examined by inserting a straight yarn with the length of  $\varepsilon d$  in the crown of loop, and a length structure by inserting a space  $\varepsilon d$  along the wale line  $O_1O_2$  and by inserting a straight line parallel to the course line. Similarly a straight length  $\xi d$  was inserted in the centre of each loop. The increase in course spacing was virtually equal to the added length of yarn.

$$\frac{W}{d} = 4 + 2 \cdot \varepsilon \quad 12$$

$$\frac{p}{d} = 3.364 \cdot \xi \quad 13$$

$$l = 2 \cdot p + W + 5.94 \cdot d \quad 14$$

Shinn [4] also analysed the two dimensional geometrical model of plain weft knitted fabric based on by Peirce's model [3]. He compared the experimental results with the theoretical results obtained from expression generated from the Peirce two dimensional geometrical models. He also modified the Tompkins's formula [4] by which weight per square yard was predicted by using relations of stitch length, courses and wales spacing developed by Peirce.

In 1955 Leaf and Glaskin [5] pointed out that the stable knitted fabric loop structure could not be produced by the model proposed by the Peirce [3]. They showed that the Peirce considered the radius of curvature  $R = 4.172 \cdot d$  for all types of loop which gavethe discontinuity in the torsion of yarn and eventually affected the shape of loops. They proposed a geometrical model of plain weft knitted fabric in which central axis of yarn passes over a series of circular cylinder and their model composed of circular arcs as shown in Figure 4.

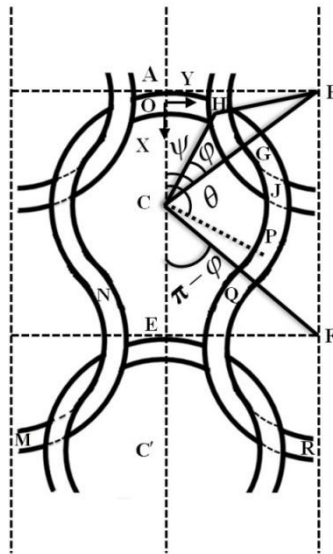

Figure 4: Leaf and Glaskin's model of plain weft knitted fabric

$$\varphi = \pi + \sin^{-1} \left( \frac{c^2 \cdot d}{[c^3 + W^2 \cdot (1 - c^2 \cdot d^2)]^{1/2}} \right) - \tan^{-1} \frac{c}{W \cdot (1 - c^2 \cdot d^2)} \quad 15$$

$$\alpha = \frac{1}{4} \cdot W \cdot d \cdot \sin \varphi \quad 16$$

$$l = 4 \cdot \left[ \frac{1}{4 \cdot W \cdot d \cdot \sin \varphi} \right] \left[ \pi + \sin^{-1} \left( \frac{c^2 \cdot d}{[c^3 + W^2 \cdot (1 - c^2 \cdot d^2)]^{1/2}} \right) - \tan^{-1} \frac{c}{W \cdot (1 - c^2 \cdot d^2)} \right] \cdot d \quad 17$$

where  $d$  is the diameter of yarn,  $W$  and  $C$  are the courses and wales spacing respectively.

In 1959 Munden [6-126] developed the relationships between stitch length and wale and course spacing. He proved that the ratios between course and wale spacing per stitch length were independent of fabric cover factor. The developed relationships are as follows:

$$\text{stitch density } (N) = Cpi \cdot Wpi = \frac{K_1}{l^2} \quad 18$$

$$Cpi = \frac{K_2}{l} \quad 19$$

$$Wpi = \frac{K_3}{l} \quad 20$$

$$K_2 \cdot K_3 = K_1 \quad 21$$

$$\frac{Cpi}{Wpi} = \frac{K_2}{K_3} = K_4 \quad 22$$

where  $K_1$ ,  $K_2$ ,  $K_3$  and  $K_4$  are constant values which can be determined experimentally on the basis of actual configuration (wet or dry relax state) of knitted loop.

Hurd and Doyle [8], Postle [9] and Kurbak [10] also studied the geometry of plain weft knitted fabrics. Furthermore, Demiroz and Dias [11] developed a mathematical model to generate 3D images of plain weft knitted fabric. They developed a stitch model by using cubic-spline as the central axis.

The software relating to their developed model required input parameters such as: yarn diameter, stitch length, course and wales spacing and other fabric parameters were calculated by a software program developed using C programming language.

Choi and Lo [12] developed a model of plain weft knitted fabric to describe the mechanical properties and dimensional change in a fabric through energy approach. Their model is also capable of predicting biaxial tensile property of knitted fabrics.

Kyosev et al. [13] developed two models of plain weft knitted fabrics. Their first model is pure geometrical model based on research work done by Choi and Lo [12] taking into consideration of the yarn cross-section as elliptical. Their second model was made in considering discretization of yarn into small element and mechanical interaction between the yarns.

Ying-lin, L., et al., [14] developed geometrical models of weft knitted fancy structures on the basis of Non-uniform Rational B-splines (NURBS) curve. They generated the yarn central axis by using a set of points at intermeshing position of yarn adopting NURBS method and created the solid shape of knit loop by sweeping the sphere along the yarn. They developed a program to generate 3D surface loop model by using Visual C++ programming language and Open GL.

Plain weft knitted fabrics were used in this study. Plain weft knitted structure is normally used for single jersey fabrics for sportswear. Different types of yarns were used to develop weft knitted fabrics to evaluate the effectiveness of the developed method.

The fabric specifications are shown in Table 1 and their surface macrostructures are illustrated in Figure 5.

*Table 1: Specifications of plain weft knitted fabrics*

Fabric code	Fibre type	Yarn count (tex)	wpc	cpc	SL (mm)	t (mm)	Surface mass (g/m <sup>2</sup> )
F1	Polyester (MF)	27.0	3.2	5.6	8.22	0.49	40.4
F2	Polyester (MF)	20.0	6.4	9.6	4.93	0.47	61.0
F3	Polyester (MF)	27.0	7.4	9.0	5.02	0.49	92.0
F4	Cotton (SF)	40.0	6.0	7.5	5.91	0.8	104.62
F5	Viscose (MFF)	33.5	6.0	9.6	5.083	0.648	102.3

MF: Monofilament; MFF: Multifilament; SF: Staple fibre; SL: Stitch length; wpc: Wales per cm; cpc: Course per cm; and t: thickness

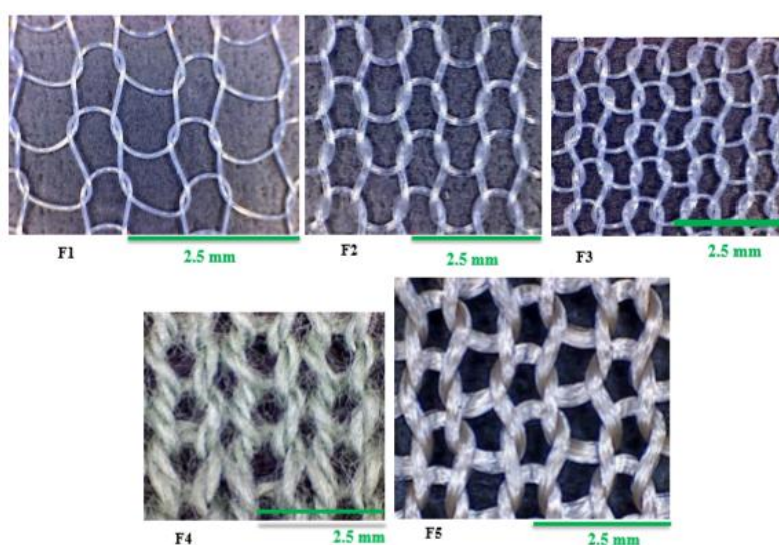

*Figure 5: Macrostructures of plain weft knitted fabrics*



## 2. FINITE ELEMENT MODEL

The parametric model of plain weft knitted fabric created by using the central axis of yarn is defined by the path shown in Figure 6a but the actual parameters of the fabric such as, courses and wales per centimetre were used. Parameter  $e$  can be determined by the average loop height  $H$  through image analysis using the following equation:

$$H = C + 2e \quad 23$$

The coordinate values of the points illustrated in Figure 6 (a) were calculated which define the central axis of yarn using spline curve in Abaqus/CAE. Abaqus/CAE calculates the shape of the curve using a cubic spline fit between all points along the spline; in addition, the first and second derivatives of the spline are continuous. The 3D models of plain weft knitted fabrics can be generated by sweeping the circular cross-section of the yarn along the central axis of the yarn. Yarns were assumed to be incompressible in nature.

A polyester plain weft knitted fabric F3 model generated by the plug-in is shown in Figure 7.

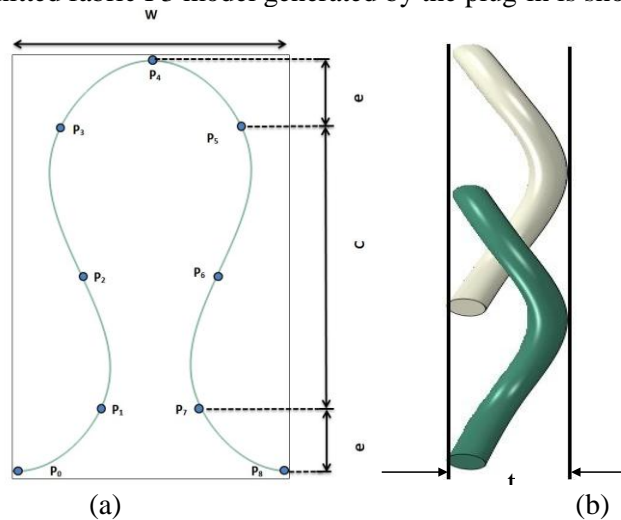

Figure 6: Geometrical parameter (a) Yarn central axis; and (b) Thickness of fabric

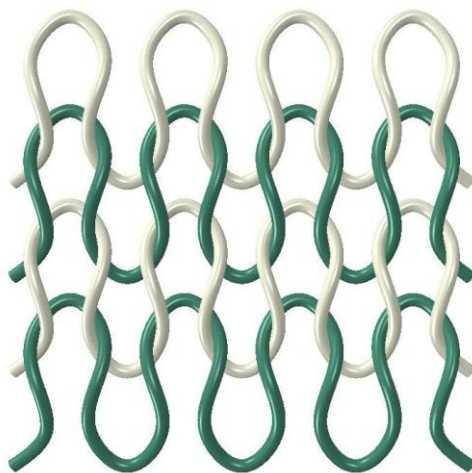

Figure 7: Geometrical model of fabric F3

## REFERENCE

- [1]. COOKE, B., (2011), *The physical properties of weft knitted structures*, in *Advances in knitting technology*, Au, K.F., Editor., Woodhead Publishing 34-47
- [2]. Chamberlain, J., (1926), *Hosiery yarns and fabrics : prepared for the textile trades advisory committee of the city of Leicester colleges of technology and art.*: Leicester : J. W. Hemmings & Capey
- [3]. Peirce, F.T., (1947), *Geometrical principles applicable to the design of functional fabrics*. Textile Research Journal, 17(3) 123-147.
- [4]. Shinn, W.E., (1955), *An engineering approach to jersey fabric construction*. Textile Research Journal, 25(3) 270-277.
- [5]. Tompkins, E., (1914), *The science of knitting.*, New York: Wiley. 330
- [6]. Leaf, G.A.V. and Glaskin, A., (1955), *The geometry of a plain knitted loop*. Journal of the Textile Institute Transactions, 46(9) T587-T605
- [7]. Munden, D.L., (1959), *The geometry and dimensional properties of plain-knit fabrics*. Journal of the Textile Institute Transactions, 50(7) T448-T471
- [8]. Hurd, J.C.H. and Doyle, P.J., (1953), *Fundamental aspects of the design of knitted fabrics*. Journal of the Textile Institute Proceedings, 44(8) 561-578
- [9]. Postle, R., (1968), *Dimensional stability of plain-knitted fabrics*. The Journal of The Textile Institute, 59(2) 65-77.
- [10]. Kurbak, A., (1998), *Plain knitted fabric dimensions (Part II)*. Textile Asia, 29(4) 36-44.
- [11]. Demiroz, A. and Dias, T., (2000), *A study of the graphical representation of plain- knitted structures part I: stitch model for the graphical representation of plain- knitted structures*. The Journal of The Textile Institute, 91(4) 463-480
- [12]. Choi, K.F. and Lo, T.Y., (2003), *An energy model of plain knitted fabric*. Textile Research Journal, 73(8) 739-748
- [13]. Kyosev, Y., Angelova, Y., and Kovar, R., (2005), *3D modelling of plain weft knitted structures of compressible yarn*. Research Journal of Textile and Apparel 9(1) 88
- [14]. Ying-lin, L., et al., (2012), *3D modelling and simulation of fancy fabrics in weft knitting* Journal of Donghua University (English Edition), 29(4) 351-358

## LEAN MANUFACTURING PRINCIPLES FOR IMPROVING PRODUCTIVITY IN THE TEXTILE INDUSTRY

Mihalj Bakator<sup>1</sup>, Dragan Čočkalo<sup>1</sup>, Miloš Vorkapić<sup>2</sup>

<sup>1</sup> University of Novi Sad, Technical faculty “Mihajlo Pupin”, Zrenjanin, Serbia

<sup>2</sup> University of Belgrade, ICTM - CMT, Belgrade, Serbia

### ABSTRACT

*In this paper the application of lean manufacturing principles, tools, and techniques are analyzed in the context of productivity increase in the textile industry. The main idea was to thoroughly analyze literature in the domain of lean manufacturing and garment manufacturing and to develop a generic, theoretical model that depicts the possibility of increasing productivity. The model depicts a generic manufacturing framework that further includes the possible approaches to productivity increase through various lean manufacturing tools. Lean manufacturing approach focuses on reducing and removing various forms of waste. Certainly, productivity, and other performance metrics in the garment manufacturing process can be improved. In this case, the improvement is based on information feedback throughout the production line. Data is gathered from the feedback loop and after analysis it is used to determine what modifications should be conducted in order to improve productivity and overall business performance.*

**Key words:** textile industry, garment manufacturing, productivity, lean manufacturing

### INTRODUCITON

Lean manufacturing can be defined as a dynamic process and as a production model that applies and combines tools, methods and various strategies with the goal to drastically reduce or to eliminate all types of waste and to reduce costs and increase productivity (Bhamu, J., and Singh Sangwan, K., 2014). The textile industry holds a large potential when it comes to increasing productivity through implementing lean manufacturing (Adikorley, R. D., Rothenberg, L., and Guillory, A., 2017). Lean manufacturing has different effects on different industries. As textile markets are volatile, and the products' lifecycles are short, it is extremely risky to accumulate volumes of storage/stock products. Based on this, textile manufacturers have to move fast, to develop products fast, and to sell them as fast as possible. Failing to do so would drastically increase production costs (Bruce, M., Daly, L., and Towers, N., 2004). Lean manufacturing implementation often relies on the readiness of employees. If the employees are not willing to participate in the lean manufacturing implementation process the possibility of failure is increasingly higher (Zhou, B., 2016). Therefore, when it comes to the textile industry, empowering employees is crucial for a successful lean manufacturing system implementation. This includes the adoption and use of tools and techniques of lean management in accordance with the company's objectives and overall business strategy goals (Wickramasinghe, G. L. D., 2011). The lean methodology originates from the Toyota Production System. The focus was to reduce all activities that don't create value for the company or for the consumer (Maia, L. C., Alves, A. C., and Leão, C. P., 2012).

In this paper lean manufacturing and productivity in the textile industry are addressed. A thorough literature review is conducted in the lean manufacturing and textile industry domain. The main idea of this paper is to analyze literature in order to determine:

1. Is lean manufacturing a viable solution for increasing productivity in an apparel production line?
2. Should the lean approach be the first option when it comes to increasing productivity in the textile industry?

Furthermore, a generic lean manufacturing model for a garment production line is developed. This way a concise overview of the reviewed literature is provided. The whole review paper consists of two main sections. The first section reviews the literature in the domain of lean manufacturing.

The second section includes the model and analyzes the positive impact of lean manufacturing on productivity in textile manufacturing companies. Afterwards, conclusions are drawn, and future research is suggested.

## **A THEORETICAL BACKGROUND OF LEAN MANUFACTURING TOOLS**

### **Just-in-time**

Just-in-time (JIT) manufacturing can be defined as reducing inventory and maintaining production systems where every module is used only when needed. This way the JIT could reduce production costs, improve product quality, increase productivity, increase management efficiency, shorter lead times etc. (Taylor, S. Y., 2008). It is important to consider the dynamic nature of textile markets. The rapid change of styles and trends put a big strain on garment manufacturers. JIT can be integrated as a production and maintenance approach with continuous smoothing of the production process (Yavuz, M., and Akçali, E., 2007). With this approach, the main idea is to reduce variability of sub-assembly tasks, and to continuously distribute the product to the end consumer (Yavuz, M., and Akçali, E., 2007). JIT manufacturing can be viewed as a flexible production strategy that focuses on decreasing the distance (physical and from the aspect of time) between different manufacturing processes. Therefore, JIT manufacturing is bias towards local outsourcing in order to manage reliable and frequent deliveries (Holl, A., Pardo, R., and Rama, R., 2010). Overall, JIT is considered to have a positive influence on several performance metrics, such as cost reduction, reduced delivery times and cycle times (Mackelprang, A. W., and Nair, A., 2010).

### **Kaizen**

Kaizen can be viewed as a continuous improvement and a systematic approach of managers and employees (Dobi, S., 2007). Some of the main tools and techniques of Kaizen include the PDCA cycle, standardization, eliminating or reducing Muda (waste), generating discipline, employee training, 5S principle, total flow management, observation and experimentation, and other problem-solving methodologies (Suárez-Barraza, M. F., Ramis-Pujol, J., and Kerbache, L., 2011). In a case study conducted in Nigerian small and medium-sized enterprises (SMEs), it was noted that the Kaizen approach has the potential to reduce production costs thus improving business survivability and business profitability (Olabisi, J., Sokefun, A. O., and Oginni, B. O., 2012). In order to effectively implement the Kaizen concept it is necessary to address the contributing factors and the challenges in the implementation process. Some of the contributing factors include top management communication with employees; top management commitment and integration of various strategies, procedures, policies and goals; the presence of a “Kaizen champion”, a person that has extensive knowledge about Kaizen implementation and it is committed to its successful implementation; horizontal organizational structure; and employee empowerment (Maarof, M. G., and Mahmud, F., 2016).

Some of the challenges of Kaizen implementation are lack of employee motivation; mature employee confusion about continuous improvement; most importantly companies often lack the continuous improvement factor which further includes lack of employee focus, and lack of understanding between top management and employees at the lower level (Maarof, M. G., and Mahmud, F., 2016).

### **Kanban**

Kanban can be defined as a system and as a tool of lean manufacturing which is used at production times with the goal to reduce inventory or to minimize inventory at any time in the production process (Rahman, N. A. A., Sharif, S. M., and Esa, M. M., 2013). In the kanban system, kanban cards are used to limit the manufacturing batches and simultaneous operations.

Batch sizes are calculated in way to ensure a constant production flow. The kanban system is one of the crucial parts of JIT (Kouri, I. A., Salmimaa, T. J., and Vilpola, I. H., 2008).

Kanban is used and established on the production floor, where the goal is to remove or drastically reduce all sources and types of waste (this includes waste in transportation, excess of motion, excess of process, employee waiting, inventory, over production and defect) (Naufal, A., Jaffar, A., Yusoff, N., and Hayati, N., 2012).

It is important to note that the kanban system has many variations. These variations emerge from the need for customization in order to be appropriate for a specific manufacturing system.

### **Total quality management (TQM)**

Total quality management (TQM) can be defined as monitoring, controlling and improving business processes with the end goal of customer satisfaction (Anvari, A., Ismail, Y., and Hojjati, S. M. H., 2011). TQM can be viewed as a set of procedures and guidelines but also as a philosophy (Anvari, A., Ismail, Y., and Hojjati, S. M. H., 2011). When it comes to TQM, there is a large set of tools and techniques that can be used to improve product or service quality. These tools and techniques are cause and effect diagram; histograms; control charts; graphs; Pareto diagram; Scatter diagram; questionnaires; flow charts; benchmarking; quality costing; quality improvement teams; statistical process control; sampling; failure mode and effects analysis (FMEA); force field analysis; brainstorming; control plans and other (José Tari, J., 2005). Furthermore, it was noted that TQM can positively influences supply chain management (Vanichchinchai, A., and Igel, B., 2011). Similarly, TQM has a positive influence on innovation of products and services (Thai Hoang, D., Igel, B., and Laosirihongthong, T., 2006). However, this is still debatable as there is a large set of factors that may affect innovation performance in the company. Taken into consideration the textile industry, it is safe to assume that TQM can achieve and it can contribute to productivity.

### **PDCA cycle**

The plan-do-check-act (PDCA) cycle can be defined as model for continuous improvement of various processes in the company. This includes recognizing external and internal opportunities for change and planning (plan) the change; testing the change (do); reviewing the conducted tests and analyzing the obtained results (check); and incorporating the acquired knowledge from the tests (act) and/or repeat the results if they are not adequate (Johnson, C. N., 2002). Now, the PDCA cycle is mainly focused on improving quality, however it can find its application for other processes. Whatever the case, the PDCA has eight steps to complete a full cycle. These steps are current condition analysis and problem detection; identification of causes; identifying the major influential factors for every cause; define an improvement plan; carry out the plan; evaluating the carried out plan and the pre-determined requirements defined in the plan; summarizing the achieved results and experiences; address unresolved problems or start new cycle. Furthermore, the PDCA cycle is a great tool to add value for customers. There are several functions that add value. These are design, innovation, quality control, logistics, manufacturing, standardization, and marketing (Gidey, E., Jilcha, K., Beshah, B., and Kitaw, D., 2014).

### **Principle 5S**

The 5S principle can be defined as a tool that is used to improve the lean manufacturing process, with the goal to achieve highly efficient and effective work environments through visual control of the workplace (Falkowski, P., and Kitowski, P., 2013). The 5S stands for Seiri (eng. Selection), Seiso (eng. Cleaning), Seiton (eng. Systematization), Shitsuke (eng. Self-discipline), and Seiketsu (eng. Standardization) (Falkowski, P., and Kitowski, P., 2013; Vorkapić, M., Čoćkalo, D., Đorđević, D., and Bešić, C., 2017). The 5S methodology/tool can be used to increase engagement of workers to continuously improve the work environment.

This includes organizing and putting things in order in the workplace; to have the necessary tools at the right place and avoid wasting time for searching; cleaning and improving the workplace; continuously evaluate and maintain the thus far achieved results; nourish the ability to do what has to be and supposed to be done (Jaca, C., Viles, E., Paipa-Galeano, L., Santos, J., and Mateo, R., 2014). Furthermore, the 5S approach improves overall organizational performance and process performance as well.

It was noted that the 5S tool has the potential to increase production efficiency (productivity) from 67% to 88%. In addition, this increase was achieved within a few weeks (Randhawa, J. S., and Ahuja, I. S., 2017). The same research argued that the 5S approach can significantly improve quality, work culture and productivity in SMEs.

### A MODEL FOR IMPROVING PRODUCTIVITY

This theoretical model for improving productivity aims at providing a more precise overview of lean manufacturing implementation possibilities and the use of its tools in the textile industry. The model is based on literature in the domain of lean manufacturing in the textile industry, lean management theory and lean manufacturing tools (Manfredsson, P., 2016; Karthi, S., Devadasan, S. R., Selvaraju, K., Sivaram, N. M., and Sreenivasa, C. G., 2013; Ajmera, R., Umarani, P., and Valase, K. G., 2017; Maia, L. C., Alves, A. C., and Leão, C. P., 2013) The model is depicted on Figure 1.

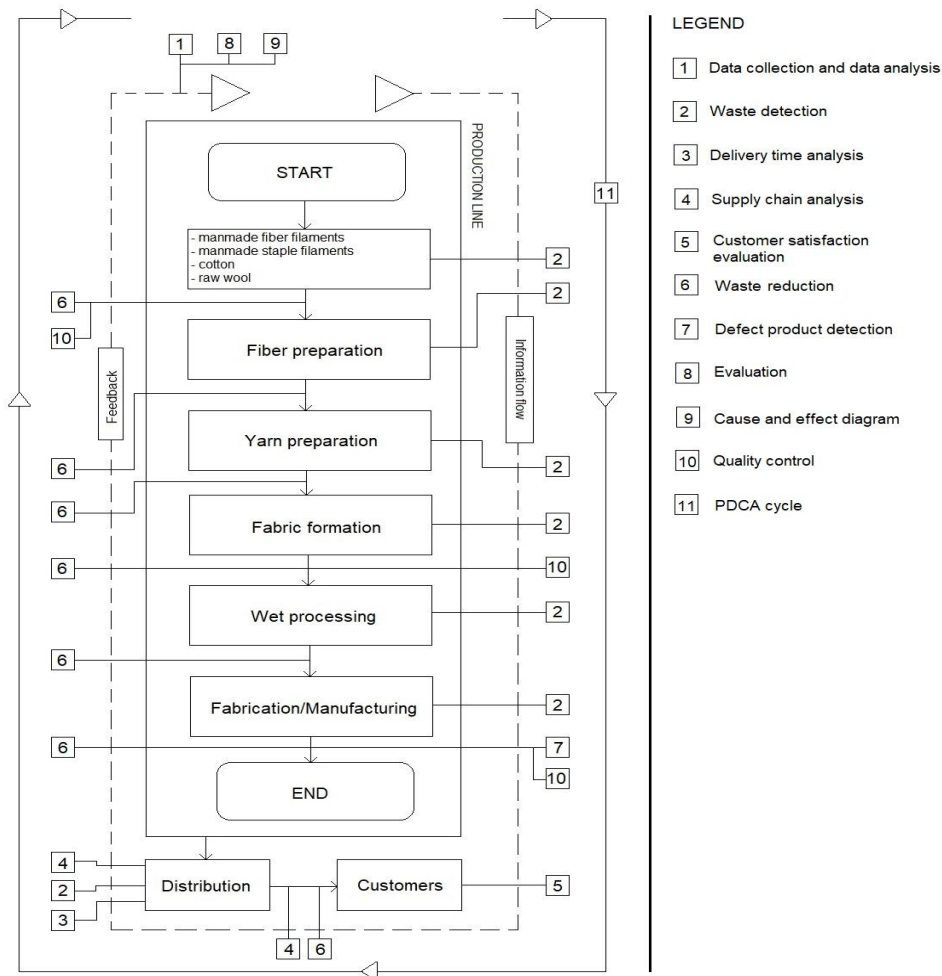

Figure 1: A theoretical model for productivity increase

The model depicted on Figure 1 includes several lean manufacturing tools with the goal to increase overall productivity. The main tool is waste detection and waste reduction. Furthermore, information flow and data obtained from the feedback loop is crucial for production line improvement. The overall data analysis and evaluation from the feedback loop can be used for the PDCA cycle. Detecting and defining problems in the production line are used to plan possible changes and improvements. Next, these changes are implemented and evaluated.

Finally, if there are still problems (overproducing, time wasting, large inventory, delay in the supply chain etc.) these are addressed and corrected or the cycle is repeated.

## **CONCLUSION**

This paper briefly analyzed and described several lean manufacturing tools. Additionally, the use of these tools in the textile industry (garment manufacturing) is examined.

After a thorough analysis of credible literature in this domain, a theoretical model was developed. This model depicts a production line in the textile industry. The distribution module and the customers as a module are also presented. The whole production process includes several modules. The goal was to present the possible application of lean manufacturing tools/techniques/actions in a generic production line. However, there is a large set of factors that can affect productivity. Based on the reviewed literature, through lean manufacturing tools and techniques, productivity can be increased in the textile industry. It is necessary to address the importance of employee satisfaction and overall organization culture. The lean manufacturing approach measures, and analyses various performance metrics. Lean manufacturing is primarily focused on removing waste from the manufacturing process. Furthermore, implementing the Kaizen approach can positively influence productivity. It can be concluded that the textile industry (garment manufacturing) is similar to other manufacturing companies. There are factors that can severely affect the business performance of garment manufacturing, such seasonal trends and low distribution efficiency. Now, the two research questions mentioned in the "Introduction" section of this paper are addressed:

1. Is lean manufacturing a viable solution for increasing productivity in an apparel production line?

After a thorough analysis of literature in this domain, it can be safely assumed that lean manufacturing is an adequate approach for increasing productivity.

2. Should the lean approach be the first option when it comes to increasing productivity in the textile industry?

It is necessary to address several issues before definite actions are taken. Low productivity can be caused by a large set of factors. If employees are unsatisfied, implementing lean manufacturing wouldn't make a big difference in productivity.

The main limitation of this paper is the generic model that presents the production line. However, given the concise nature of the paper, this limitation is not severe. For future research, the lean manufacturing tools and techniques should be addressed in more detail. Additionally, a meta-analysis of productivity increase possibilities in the textile industry should be conducted. This way a more broad view can be achieved on this subject.

## **ACKNOWLEDGEMENT**

This work is a result of the project financed by the Ministry of Education, Science and Technological Development of the Republic of Serbia, Grant TR 35017 and Grant TR32008.

## REFERENCES

- [1] Adikorley, R. D., Rothenberg, L., & Guillory, A. (2017). Lean Six Sigma applications in the textile industry: a case study. *International Journal of Lean Six Sigma*, 8(2), 210-224.
- [2] Ajmera, R., Umarani, P., & Valase, K. G. (2017). Lean Six Sigma Implementation in Textile Industry. *International Research Journal of Engineering and Technology*, 4(04), 1670.
- [3] Anvari, A., Ismail, Y., & Hojjati, S. M. H. (2011). A study on total quality management and lean manufacturing: through lean thinking approach. *World applied sciences journal*, 12(9), 1585-1596.
- [4] Bhamu, J., & Singh Sangwan, K. (2014). Lean manufacturing: literature review and research issues. *International Journal of Operations & Production Management*, 34(7), 876-940.
- [5] Bruce, M., Daly, L., & Towers, N. (2004). Lean or agile: a solution for supply chain management in the textiles and clothing industry?. *International journal of operations & production management*, 24(2), 151-170.
- [6] Dobi, S. (2007, June). The Kaizen and the productivity. In *5th international conference on Management, Enterprises and Benchmarking*. Budapest, Hungary.
- [7] Falkowski, P., & Kitowski, P. (2013). The 5S methodology as a tool for improving organization of production. *PhD Interdisciplinary Journal*, 4(1), 127-133.
- [8] Gidey, E., Jilcha, K., Beshah, B., & Kitaw, D. (2014). The plan-do-check-act cycle of value addition. *Industrial Engineering & Management*, 3(124), 2169-0316.
- [9] Holl, A., Pardo, R., & Rama, R. (2010). Just-in-time manufacturing systems, subcontracting and geographic proximity. *Regional Studies*, 44(5), 519-533.
- [10] Jaca, C., Viles, E., Paipa-Galeano, L., Santos, J., & Mateo, R. (2014). Learning 5S principles from Japanese best practitioners: case studies of five manufacturing companies. *International Journal of Production Research*, 52(15), 4574-4586.
- [11] Johnson, C. N. (2002). The benefits fo PDCA. *Quality Progress*, 35(5), 120.
- [12] José Tarí, J. (2005). Components of successful total quality management. *The TQM magazine*, 17(2), 182-194.
- [13] Karthi, S., Devadasan, S. R., Selvaraju, K., Sivaram, N. M., & Sreenivasa, C. G. (2013). Implementation of Lean Six Sigma through ISO 9001: 2008 based QMS: a case study in a textile mill. *Journal of the Textile Institute*, 104(10), 1089-1100.
- [14] Kouri, I. A., Salmimaa, T. J., & Vilpola, I. H. (2008). The principles and planning process of an electronic kanban system. In *Novel algorithms and techniques in telecommunications, automation and industrial electronics* (pp. 99-104). Springer, Dordrecht.
- [15] Maarof, M. G., & Mahmud, F. (2016). A review of contributing factors and challenges in implementing Kaizen in small and medium enterprises. *Procedia Economics and Finance*, 35, 522-531.
- [16] Mackelprang, A. W., & Nair, A. (2010). Relationship between just-in-time manufacturing practices and performance: A meta-analytic investigation. *Journal of Operations Management*, 28(4), 283-302.
- [17] Maia, L. C., Alves, A. C., & Leão, C. P. (2012, November). Design of a Lean Methodology for an ergonomic and sustainable work environment in Textile and Garment Industry. In *ASME 2012 International Mechanical Engineering Congress and Exposition* (pp. 1843-1852). American Society of Mechanical Engineers.
- [18] Maia, L. C., Alves, A. C., & Leão, C. P. (2013). Sustainable work environment with lean production in textile and clothing industry. *International Journal of Industrial Engineering and Management*, 4(3), 183-190.
- [19] Manfredsson, P. (2016). Textile management enabled by lean thinking: a case study of textile SMEs. *Production Planning & Control*, 27(7-8), 541-549.
- [20] Naufal, A., Jaffar, A., Yusoff, N., & Hayati, N. (2012). Development of Kanban system at local manufacturing company in Malaysia—case study. *Procedia Engineering*, 41, 1721-1726.
- [21] Olabisi, J., Sokefun, A. O., & Oginni, B. O. (2012). Kaizen Cost Management Technique and Profitability of Small and Medium Scale Enterprises (SMEs) in Ogun State, Nigeria. *survival*, 3(5).



- [22] Rahman, N. A. A., Sharif, S. M., & Esa, M. M. (2013). Lean manufacturing case study with Kanban system implementation. *Procedia Economics and Finance*, 7, 174-180.
- [23] Randhawa, J. S., & Ahuja, I. S. (2017). 5S implementation methodologies: literature review and directions. *International Journal of Productivity and Quality Management*, 20(1), 48-74.
- [24] Suárez-Barraza, M. F., Ramis-Pujol, J., & Kerbache, L. (2011). Thoughts on kaizen and its evolution: Three different perspectives and guiding principles. *International Journal of Lean Six Sigma*, 2(4), 288-308.
- [25] Taylor, S. Y. (2008). Just-in-time. In *Handbook of Logistics and Supply-chain Management* (pp. 213-224). Emerald Group Publishing Limited.
- [26] Thai Hoang, D., Igel, B., & Laosirihongthong, T. (2006). The impact of total quality management on innovation: Findings from a developing country. *International journal of quality & reliability management*, 23(9), 1092-1117.
- [27] Vanichchinchai, A., & Igel, B. (2011). The impact of total quality management on supply chain management and firm's supply performance. *International Journal of Production Research*, 49(11), 3405-3424.
- [28] Vorkapić, M., Čočkalović, D., Đorđević, D., & Bešić, C. (2017). Implementation of 5S tools as a starting point in business process reengineering. *Journal of Engineering Management and Competitiveness (JEMC)*, 7(1), 44-54.
- [29] Wickramasinghe, G. L. D. (2011). *Analysis of the effect of duration of lean implementation on work performance in the textile and apparel companies in Sri Lanka*. Annual Academic Sessions, Open University of Sri Lanka.
- [30] Yavuz, M., & Akçali, E. (2007). Production smoothing in just-in-time manufacturing systems: a review of the models and solution approaches. *International Journal of Production Research*, 45(16), 3579-3597.
- [31] Zhou, B. (2016). Lean principles, practices, and impacts: a study on small and medium-sized enterprises (SMEs). *Annals of Operations Research*, 241(1-2), 457-474.

## A RESEARCH OF COMFORT PROPERTIES OF 1x1 RIB KNITTED FABRIC

**Marija Pešić, Vasilije Petrović, Danka Joksimović, Anita Milosavljević**

Technical faculty "Mihajlo Pupin", Zrenjanin

e-mail: marija.stankovic.986@gmail.com

### APSTRACT

*In this paper it is presented the impact of the yarn counts of the 1: 1 RIB cotton, bleached knitted material on the air permeability and relative humidity. Knitwear that are used for examination are commercially used for the production of clothes of next-to-skin-wear. The eight samples of RIB knitted material were analyzed, and they are made from 100% cotton yarn with different linear densities and with 96% cotton yarn and 4% of Lycra (44dtex). Used cotton yarn for samples are with linear density of 19, 17, 15 and 13 tex. From the obtained results we can see that in the cold wetter conditions, the knitwear sample (BL1) made from 96% cotton and 4% lycra (yarn count 19tex) are most suitable for wearing next to the skin.*

**Key words:** air permeability, relative humidity of the knitwear, yarn count

### INTRODUCTION

Clothing comfort is very important feature of clothes which should satisfy modern fashion products through the coldness/warmth feeling i.e. comfort. The comfort is considered as a result of balanced process of heat exchange between the human body, clothing and environment. The garments can be seen as a heat exchange layer between the body and its environment, and contemporary requirements regarding clothing comfort are much higher than in the past. Comfort is also an important factor in business garments, since they are intended to be worn throughout the whole day in different environmental conditions [1].

The air permeability of knitted materials is one of the most important characteristics. From the results of air permeability certain conclusions can be made about the porosity of the knitwear, as well as the isolation capabilities of certain products [2].

When it comes to air permeability, it refers to the wind, which is most often defined with two basic parameters: speed and direction [2]. The wind hinders the movement, going through the clothes and thereby carries a certain amount of heat, which means that we have to use more energy than in a calm atmosphere. In a cold atmosphere, the wind causes an increase in the amount of heat that passes through clothing in the environment and in certain circumstances accelerates the cooling of the human organism [3].

The main aim of this paper is to compare air permeability and relative humidity of knitwear made from cotton/lycra. All the samples are made from different yarn counts with RIB structure. Thus, this could allow the manufacturers to manufacture cost-efficient knitwear with optimum properties. In this way the consumers would have the opportunity to buy products with required properties, for a better price.

## MATERIAL AND METHODS

Experimental part of this paper was carried out using the knitwear that are commercially used for the production of clothes of next-to-skin-wear. This kind of clothes are worn either as one-layer summer wear or as the first layer that is in contact with human skin in cooler season of the year. The knitwear samples are produced with 1x1 RIB structure. Samples are made of 100% CO yarns and CO yarns in combination with Lycra (96% CO / 4 % LY).

Linear density of Lycra which was used is 44dtex. CO yarn was used in four linear densities : 19, 17, 15 and 13 tex. Samples were in bleached state. The characteristic of the knitwear samples are shown in the table 1.

Knitwear are made on a circular knitting machine type Fv 2.0 of company Mayer & Cie. Characteristics of the machine are as follows: cylinder diameter 19 "(inch), the gauge is E18 and with 40 feeders, the knitting speed is 1.7 m / s. All of the samples are knitted under the same conditions on the same machine.

*Table 1. Basic characteristics of analyzed knitwear's samples*

Samples	BP1	BP2	BP3	BP4	BL1	BL2	BL3	BL4
BL3SBstructure	1x1RIB	1x1RIB	1x1 RIB	1x1RIB	1x1 RIB	1x1 RIB	1x1 RIB	1x1 RIB
Fiber composition	100% CO	100% CO	100% CO	100% CO	96% CO / 4% LY	96% CO / 4% LY	96% CO / 4% LY	96% CO / 4% LY
Linear density (tex/dtex)	19	17	15	13	19/44	17/44	15/44	13/44
Twists (m-1)	565	627	655	693	565/-	627/-	655/-	693/-
Mass per unit area (g m <sup>-2</sup> )	190.83	178.55	146.42	122.32	285.44	254.33	219.2	181.23
Finishing	bleached	bleached	bleached	bleached	bleached	bleached	bleached	bleached

All fabric samples were conditioned by being kept under the atmosphere conditions ( $20 \pm 2^{\circ}\text{C}$  temperature and  $\% 65 \pm$  relative humidity) for at least 24 hours before the experimental studies.

### Determining the moisture content of the material (or determining the relative humidity of the material)

A device HB 43 (Mettler Toledo) was used to determine the moisture content of knitted fabrics. This device allows simultaneous measurement and drying the sample in a closed container until the balance is reached between the weight of the sample and time. The moisture content is expressed in percentages of wet weight, i.e. initial mass WW. The moisture content is indicated on a device with "% MC" (Moisture content) and can be defined by formula:

$$MC [0 \dots + 100\%] = \frac{WW - DW}{WW} \cdot 100$$

where is:

MC - moisture content, %,  
WW, mass of the wet sample, g,  
DW, mass of the dry sample, g.



Figure 1. A device HB 43 (Mettler Toledo) for determination the moisture content of knitted fabrics

### Determination of air permeability

Air permeability is defined as the air flow velocity that passes vertically through the defined surface, at a given pressure difference between the two surfaces of the material [2].

Tests are carried out in accordance with ISO 9237 using the TexTest FX3300 tester for air permeability (Figure 1). The given pressure difference between the two surfaces is 100Pa.

The air permeability is one of the most important features and can be defined as the velocity of the air flow that passes vertically through the defined surface at a given pressure difference between the two surfaces of the material. [2]:

$$v = 1,33 \cdot h^{0,5}$$

where is :

v – wind speed [m/s]

h – pressure [Pa]

1,33 and 0,5 are empirical constants of certain dimensions

Depending on the results of air permeability, we can make certain conclusions about the porosity of the structure of knitwear as well as the isolation capabilities.

The standard for conducting air permeability testing is ISO 9237: 1995. Measuring device on which the knitwear samples were tested was TexTest FX3300. The air flow passes vertically through the given area of the material under the precise conditions of the examined area, and the pressure and time are observed. The test was carried out on a measuring surface of 20 cm<sup>2</sup>. Testing apparatus comprising means for clamping, in order to ensure a sample of curling. During the test, it was considered that the air did not pass on the side of the tested sample. In each sample, 20 measurements were made in different places.

### RESULTS AND DISCUSSION

The mean values, standard deviations and measurement units of air permeability and moisture humidity in the knitwear which were obtained from the standard measurements conducted on the knitwear are shown in table 2. The significance value within the study was acknowledged as (p) 0,05. If significance value (p) of parameter was greater than 0,05 (p>0,005), it was interpreted that the parameter did not make a statistically significant difference.

One Way Analysis of Variance (ANOVA) was conducted on the independent samples in order to determine if yarn counts of the fabrics showed statistically significant differences on the air permeability and relative humidity of knitwear.

*Table 2 : A results of standards measurements of the knitwear samples*

Sample	Air permeability (l/m <sup>2</sup> /sec)			Relative humidity of the knitwear (%)		
	Number of measurements	Mean	Standard deviation	Number of measurements	Mean	Standard deviation
BP1	10	462	12.29273	10	6.772	0.1277
BP2	10	508	15.49193	10	6.401	0.10577
BP3	10	900	94.2809	10	6.112	0.01033
BP4	10	1440	51.63978	10	5.941	0.12306
BL1	10	51	6.14636	10	6.979	0.28486
BL2	10	116	15.77621	10	6.505	0.09265
BL3	10	142	15.49193	10	6.236	0.17532
BL4	10	426	41.41927	10	5.782	0.27571

There are two hypotheses of ANOVA analysis that are conducted for each property. Null Hypothesis: The means of all levels are equal. Alternative Hypothesis: The means of one or more levels are different. At the 0,05 level, the population means are significantly different.

Levene test was conducted before the ANOVA analysis. Levene test was done for variance homogeneity. It was seen that variances were homogeneous. In order to define the relationship between the fabrics, Tukey HSD multiple comparison test was conducted.

**Relative humidity of the knitwear**

According to the results of Levene test,  $F=16.96955$  and significance level was  $p=4.87716^{-13}$ . In this case it was observed that distribution variances were homogeneous. According to the ANOVA results  $F=55.38073$  and  $p=1.80766^{-26}$ . Therefore Alternative hypothesis was accepted. That mean that there is statistically significant difference between the relative humidity of the knitwear values o the fabric. According to Tukey Hsd multiple comparison test we can see that there is mostly significant difference between samples, except between samples BL4 and BP4, BL3 and BP3, B13 and BP2, BL2 and BP2, BP4 and BP3 (figure 2)

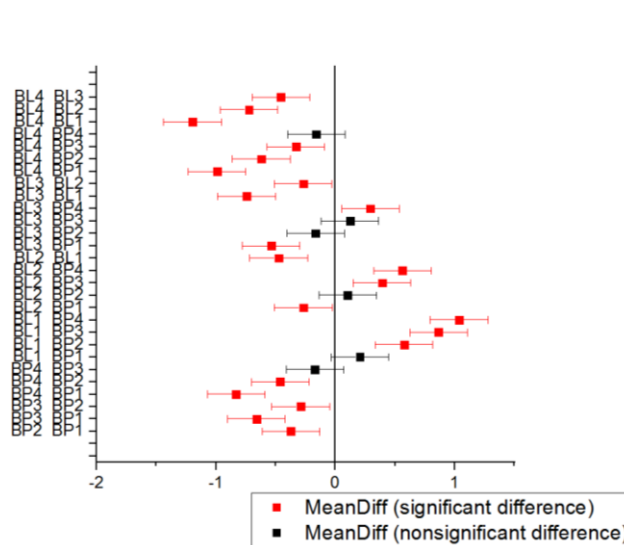

*Figure2: Tukey HSD multiple comparison test for relative humidity of knitwear  
Air permeability*

According to the results of Levene test,  $F=20.3425$  and significance level was  $p=8.534^{-15}$ . In this case it was observed that distribution variances were homogenous. According to the ANOVA results  $F=1230.38075$  and  $p=3.02423^{-72}$ . Therefore Alternative hypothesis was accepted. That mean that there is statistically significant difference between the air permeability values o the fabric. According to Tukey Hsd multiple comparison test (Figure 3) we can see that only differences between samples BL4 and BP1 , B13 and BL2 and BP2 and BP1 did not showed significant difference.

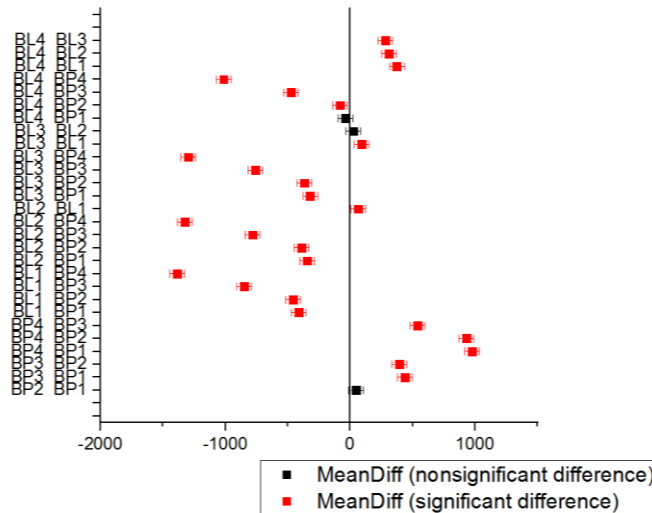

Figure 3: Tukey HSD multiple comparison test for air permeability

## CONCLUSIONS

RIB knitwear have often been used in next to skin clothes in colder weather or like single garment in summer season. Heat and moisture transfer properties should be good so that they can have optimum properties.

From the obtained results we can see that in the cold wetter conditions, the knitwear sample (BL1) made form 96% cotton and 4%lycra (yarn count 19tex) are most suitable for wearing next to the skin. Air permeability of this sample is  $51(l/m^2/sec)$ . Also for the summer period the sample maid from 100% cotton with yarn count 13tex are most suitable for next to skin wear because its porous structure gives the cooler feeling.

regarding the relative humidity of the knitwear we can see from the obtained results that the most suitable knitwear are from 96%cotton and 4% lycra and it was maid from cotton yarn count of 19tex.

## REFERENCES

- [1] D. Celcar, J. Geršak, H. Meinander, THE INFLUENCE OF ENVIRONMENTAL CONDITIONS ON THERMO PHYSIOLOGICAL WEAR COMFORT OF BUSINESS CLOTHING, 5th International conference Innovation and Modelling of Clothing Engineering Processes - IMCEP 10-12, 2017 (141-149)
- [2] Dragana Grujić – Uticaj fizičko-mehaničkih osobina poliestarskih tkanina i konstrukcije krojeva na termofiziološka svojstva odeće – Magistarski rad, Leskovac, 2003;
- [3]E. Utkun, A research in various comfort properties of interlock knitted fabric, Industria textila, vol 66 (2015) 23-33

- [4]Gözde ERTEKİN\*, Arzu MARMARALI – Heat, Air and Water Vapor Transfer Properties of Circular Knitted Spacer Fabrics, 2011;
- [5] Naray Ucar, Turgut Zilmaz – Thermal properties of 1x1, 2x2, 3x3 Rib Knit Fabrics – Fibers and Textiles in Eastern Europe
- [6] V. Petrović, M.Savić, D.Trajković, M. Reljić: The analysis of the knitted fabrics' characteristics substantial for the thermophysical comfort of clothes, Menadžment, Inovacije, Razvoj, Volume 5, No.16, str. 3 - 10, (2010).
- [7]S.Stojiljković, V. Petrović, J. Stepanović, M. Reljić, S.Sinđelić: Analiza uticaja tekstilnih i ostalih materijala na udobnost spavanja, međunarodni naučno-stručni skup »ENERGETSKA TEHNOLOGIJE – 2010. – sa tematskom konferencijom: MENADŽMENT, INOVACIJE, RAZVOJ«, SRBIJA SOLAR, 21 maj 2010., Vrnjačka Banja, (rad štampan u Zborniku radova u elektronskoj formi)

## PROPERTIES OF GEOTEXTICAL MATERIAL AND THEIR APPLICATION

Anita Milosavljević, V. Petrović, D. Joksimović, S. Sindelić, N. Petrović  
\*Faculty of Technology Leskovac, University of Nis - The scholarship holder of the Ministry

\*Technical Faculty "Mihajlo Pupin", Zrenjanin,  
Đure Đakovića bb, 23000 Zrenjanin  
mail: [anita.milosavljevic@hotmail.com](mailto:anita.milosavljevic@hotmail.com)

### ABSTRACT

*In this paper we describe the characteristics of geotextile materials and its use, because demand and interest for it are constantly increasing, geosynthetics allows us to provide an appropriate solution for all possible construction problems, on the very ground where textiles are more and more represented, and in this way it also affects the quality of construction. The most widely used geosynthetics is geotextile, and it meets most of the requirements for the formation of materials on the ground, and today it is impossible to imagine a quality and safe construction without a well-insured and well-equipped base, which incorporates geotextiles.*

**Key words:** Geotextiles, geoweb, geosynthetics.

### 1. INTRODUCTION

The textile industry is one of the most modern and most capable economic sectors in the country and the world. Textiles and textile composites can be found in airplanes, automobiles, ships, in the construction and setup of roadways, roads, in air engineering, without textiles these areas are no longer competitive today.

Massive weight savings and a much higher load limit make up an integral part of the fiber and cause them to become everywhere unavoidable. As an example, we can take the airplane industry, today's modern planes are mainly made of fiber from plastic materials. Textile components are essential in energetic and ecological engineering. In civil engineering, textile insulating material makes a significant contribution, reduces energy consumption and thus reduces CO<sub>2</sub>. Textile concrete plays an increasingly important role in road construction, the construction of bridges, the use of waiting times in medicine, the production of an implant to the wound dressing product, and the replacement of organs. While it was once attributed mainly to the fashion industry, today it has become an integral part of everywhere around us and leads us to devote special attention to the study of such textile materials.

This paper will describe the characteristics of geotextile materials and its application, as demand and interest for it are constantly increasing, geosynthetics enables us to provide an appropriate solution for all possible construction problems, on the very ground where the textile is more and more represented. The way it affects the quality of construction. The most widely used geosynthetics is geotextile, and it satisfies most of the requirements for the formation of materials on the ground, and today it is impossible to imagine quality and safe construction without a well-insured and well-arranged base in which geotextiles are incorporated.



The high strength and quality of the geotextile results in high quality when in use, keeps the ground fixed, at the same time it passes a liquid that could find the bases and splits two different floors from mixing, where it is extremely important that one of the characteristics of the material is not disturbed by the other. They represent ideal materials for infrastructure works such as roads, ports and many others, based on which they will have a bright future in use.

## 2. Characteristics and application of geotextiles

Geotextile is a polymeric - synthetic or natural textile material. It can be nonwoven, knitted or woven, used in contact with soil and /or other materials in geotechnical and other construction activities, embankment reinforcement or construction work. Woven fabrics in geotextiles are permeable fabrics and are used in countries that have the ability to separate, filter, protect or remove. The application includes construction, land and road construction, dam engineering, soil sealing and drainage systems. The fabric used must have good strength, durability, low absorption of moisture and thickness. It mainly uses non-woven and woven materials.

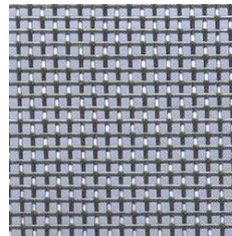
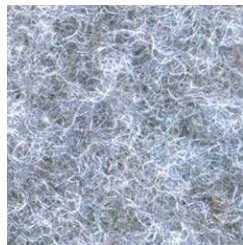
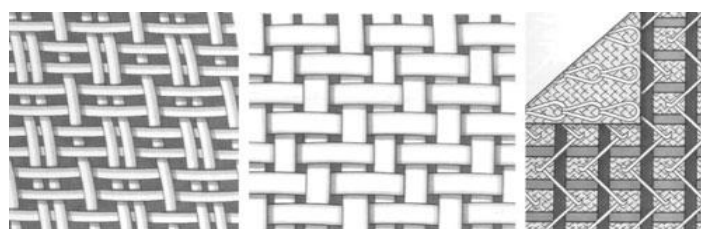

*Photo 1. Display of non-woven textile      Photo 2. Display of woven textile*

**Non-woven geotextile (GTnw)** is made of synthetic fibers that are processed and mechanically or thermally bound

**Woven geotextile (GTw)** is produced by weaving two or more synthetic fibers:

- parallel with the direction of weaving
- vertically in relation to weaving



*Photo 3. Display of woven geotextile, produced from two or more synthetic fibers*

**Geogrids - geogrids (GG)** can be: extruded, knitted and bound. Their main purpose is to strengthen and improve the structure of the land.

**Extruded geogrids** - products are most commonly of high density polyethylene or polypropylene extruded, and then drawn in one direction

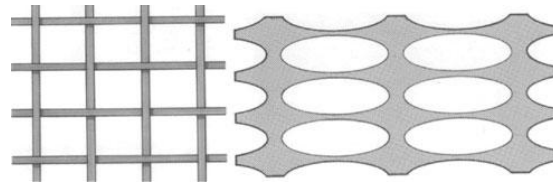

*Photo 4. Display of extruded geogrid*

**Knit geogrids** - products are most commonly made of *high modulus* of polyester synthetic fibers, coated with synthetic material, which provides resistance to joints.

**Linked geogrids** - they are made of two or more fibers by bonding. These grids are usually a composite consisting of a central core made of polyester fibers of high strength and durability and a protective layer i.e. polyethylene lining. In addition, there are also products in combination with geotextile.

**Biotextile and Biomat (BT)** - biotextile is produced from natural fibers (jute, coconut fibers, etc.) assembled into a composite that is a flexible form of soil to which it is laid. These products are used as a temporary solution to protect against soil erosion, especially slopes, until vegetation grows and takes on this role.

**Biomat** is produced in combination of natural fibers (straw, coconut fibers, agave fibers, etc.) inserted between grids made of synthetic materials (polypropylene or polyamide) or natural materials (jute). His main purpose is as the same as bioetextile's.

**Geomats (GA)** - geomat is made of synthetic materials (high density polyethylene, polyamide, polypropylene and others) intricated in a deformable form 10-20 mm thick..Used on slopes to improve resistance to erosion caused by rain and water.

**Geocell (GL)** - consists of cells arranged together with strips of extruded synthetic materials in the form of honeycomb. Geocell's main function is to keep the ground or other loose material in place to prevent sliding down the slope.

**Geonet (GN)** - a web made of two folded series of fibers that are crossed at a constant angle (between 60 ° and 90 °) forming constant and regular openings.

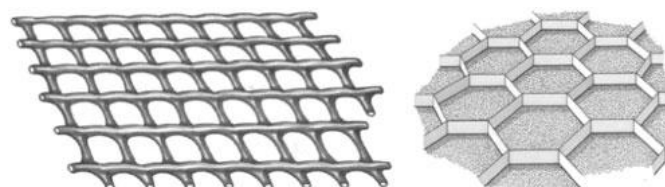
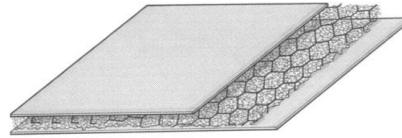

*Photo 5. Geonet web made of two folded series of fibers*

These nets are manufactured from extruded thermoplastic polymers. Geonet in combination with geotextile (it has a filter function) and /or geomembrane (it has a barrier function) can be used for drainage.

**Drain Geosynthetics (GCD)** - can be made both homogeneous and composite material.

Composite materials are also called a geocomposite for drainage. They are composed of geonets or geomat layers inserted between two layers of geotextile



*Photo 6. . Composite material or geosynthetics for drainage*

**Glineni geosintetički materijali (GCL)** -Ovo su proizvodi napravljeni od bentonita i geosintetike: tanak sloj gline koja nabubri umetnuta između dva sloja geotekstila ili zalepljena za sintetičku membranu.

**Geosynthetic Clay Materials (GCL)** -These products are made of bentonite and geosynthetics: a thin layer of clay inserted between two layers of geotextile or glued to the synthetic membrane.

We share them in three types:

- **The first type** - a bentonite layer fixed between two layers of geotextile sewn up one after the other
- **The second type** - made of sodium bentonite mixed with soluble adhesive and placed between two layers of geotextile
- **The third type** - consists of bentonite with adhesive which connects it with geomembrane (HDPE). As with the other type and this is self-sealing

**Synthetic geomembranes (GMS)** - can be homogeneous and reinforced. They can also be plastic and elastomeric.

**Plastomeric geomembranes** - strips of thickness 0.5-2.5mm and with low coefficient of permeability. They are made with a mixture of thermoplastic polymers (LDPE, HDPE, PVC, PP) and several different additives melted and reduced to the required thickness.

**Elastomeric membranes** - are strips of thickness of 0.5-2.0mm, with a small coefficient of permeability. They are produced in two phases. In the first stage, a homogenized mixture consisting of an unvulcanized polymer and several different additives is produced. In the second phase, the homogeneous mixture is passed through the heated rollers and in this way leads to the required thickness, while vulcanising at the same time to obtain a straight tape.

**Bitumen geomembranes (GMB)** - 3-6mm thickness tapes. They are made by making a moulded mixture consisting of bitumen, plastic and elastomeric polymers and mineral fillers. The reinforcing layer can be: woven or non-woven polyester felt or glass fleece. These membranes are used for waterproofing roofs and for geotechnical and hydro projects: channels, dams, reservoirs ... Synthetic fibers such as glass, polypropylene and acrylic fibers are used to prevent the cracking of concrete, plastic and other building materials. Polypropylene and polyester are used in geotherapy and dry / liquid filtration, due to their compatibility



*Photo 7. Geo-tekstile*

The complex three-dimensional structure of geotextile, formed by random layout of fibers, and the material itself can be a permeable and compressive material. They belong to groups that support geoscientists, geologists, geomembranes and geocomposites.

Geotextile is defined as any textile material, that is, a missed geosynthetics oriented from textile materials, used for filtering, drainage, separation, strengthening and stabilization as an integral to building structures from earth, walls and other building materials.

For different geosynthetic products, geotextiles are materials that can be used for the widest range of applications for different purposes. Plastic mass is a group of organic materials, consisting of connective polymeric components and various additives, such as: hardeners, plasticizers, stabilizers, pigments ... For the strength and resistance of polymers, fatty cellulose is the most important, with the increase in molecular weight, hardness, has a greater clamping ability, shock resistance, heat resistance, resistance to release.

### **3. Performance of geotextile materials**

Performance and their parameters include:

- 1) **Permeability:** the ease of air flow or liquid through the fabric. The permeability of the fabric is greater when the porosity of the fabric is high. The bulk or fraction, porosity and fibers (1-porosity) refer to packaging efficiency, which is influenced by fiber diameter and cross-section geometry, and this is a powerful function of the fiber diameter or yarn for a particular fiber structure (fiber orientation).
- 2) **Complexity:** The ability of the fabric to counterbalance the transverse fabric (through thickness) by compression. The large fabric has a tendency to be more compressive. On the other hand, the compressibility of the stiffness of fibers and yarns, which is significantly influenced by fibers, is increasing, increasing. As the fiber diameter, stiffness, resistance and longitudinal strength of the fiber pressure increase, the magnification occurs geometrically.
- 3) **Fabric Distribution:** Measures of the fabric's ability to stretch and match. The distribution of the fabric affects the geometry of the fabric and the uniform elongation of the bending of fibers. The fine fiber yarn tends to have a greater potential for expanding the fabric.
- 4) **Toughness of the fabric:** The durability of the fabric. As reflected in areas under the stress-straining of the fabric, high-strength high-tensile fabric on breaks usually produces high toughness. Woven fabrics that have high conformity and expandability are usually harder.

Summary of geometric and performance characteristics, structure of yarns and materials, as well as structure of fibers to fabric in the form of performance map.

These performance maps show that geometric parameters play an important role in the structural and physical properties of fabrics. Fine fiber components include a geometric factor.

High elongation usually produces high toughness. Woven fabrics that have high conformity and expandability are usually harder. Summary of the geometric and performance characteristics of the structure of yarns and materials and the structure of fibers to the fabric in the form of a performance map.

These performance maps show that geometric parameters play an important role in the structural and physical properties of fabrics, the fineness of the fiber component is a key geometric factor.

#### 4. The most common areas of application of geotextile and advantages of use

Geotextile as building material is the most commonly used in the construction and maintenance of roads, because it has different application functions.

First of all, the filter used in geotechnical engineering must have its own holes, small enough to hold the ground, and at the same time it must be permeable enough to allow the water to pass as easily as possible, which makes it its main advantage in comparison with other similar materials which are used for the same or similar purposes.

Geotextiles with a primary filtering function easily restricts the flushing of small material in the passage of water from the soil layer, fine granulation to a layer of larger granulation. As a geotextile filter, it contains component parts of the soil or other particles, and in this way simultaneously allows the flow of liquid normally to a flat filter.

In this process, the mechanical stability of the filter (soil retention ability) and the hydraulic efficiency of the filter with the aim of discharging water with minimal pressure losses should be distinguished.

Geotextiles with filter function have an additional function of separation of two layers of soil, while limiting the intermingling of two layers of soil with different physical properties of the soil (granulometric composition, consistency, shrinkage). They prevent the flushing of fine particles and their penetration into coarse-grained material.

In hydrotechnical structures, this type of geotextile is applied in the protection of the coast and the bottom of the erosion watercourse and for the regulation of the watercourse. It is also used underneath the rock embankment along the shorelines to prevent soil erosion.

The filtration efficiency includes the passage of water through the material itself, while retaining the soil particles on the side from which water flows towards the geotextile. The conditions for the geotextile filter are that they must guarantee long-term protection against erosion of the banks of the channel and troughs, while at the same time preserving the mechanical and hydraulic efficiency of the filter. The only separation is in fact the introduction of a flexible porous material placed between different materials, so that the integrity and functionality of both meters remain intact or improved, and, to put it better, it can separate or implement flexible synthetic barriers between two materials whose properties are significantly different, in order to preserved the integrity and convenience of both materials. The separation function is particularly important in climatic conditions that pass through consecutive periods of freezing and thawing, where it is also one of the purpose of separation and an attempt to prevent the base material of the path to penetrate the soft subsoil of the path, which aims to maintain the projected carriageway thickness.

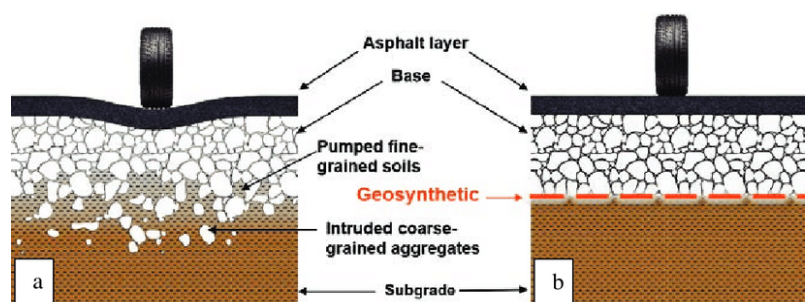

*Photo 8. Display of base material by road - a) without geotextile (with damage at a certain load) b) with geotextile (without damage at the same load)*

It can be explained in the way that when using geotextiles, the soil is separated from the first layer of embankments and from the lower carrier layer of the pavement structure (tampons), as well as to the separation of two types of soil in the embankment (for example, sand clay).

The choice of the appropriate geotextile depends on the type and granulometric composition in the base layer and the expected load on the layer in exploration, as well as the loads during installation

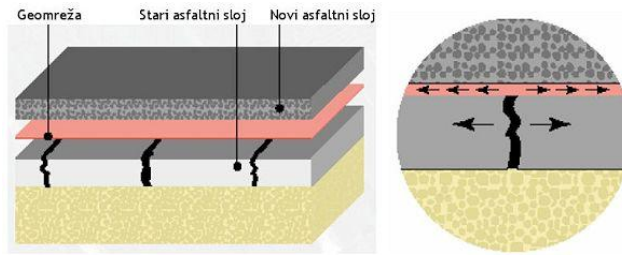

*Photo 9. Asphalt reinforcement showing by geogrid*

Areas for the use of geotextiles for the separation of layers are: construction of roads and road infrastructure, construction of hydrotechnical structures, construction of railroads and earth embankments.

## 5. GEOCOMPOSITES FOR STABILIZATION OF SKEW

Flexible geosynthetics made of a net for control of erosion connected with polypropylene geomembrane with high tensile strength and low deformability.

The spatial structure of the geoweb keeps the soil layer increasing the friction angle between the top layer of the material and is characterized by high tensile strength and a slight creep of the geogrid.

Use:

- control of erosion at slopes of great inclination and length
- protection of marginal areas
- when closing the landfill
- with new waste dumps
- for vegetation growth above geomembrane



*Photo 10. Application to new waste dumps*

## 6. Geotextile materials for the construction of roads and embankments

When embankment construction is concerned, the basic application of geotextile is to take over a part or total tensile force in the construction, such as armature for strengthening embankment, armatures in complete construction from armature soil or concrete as well as some armature in road construction..

The strengthened ground is like a wall or support slope system in which the strengthening element is built into the structure itself to improve its mechanical properties.

As the availability of suitable construction sites decreases, there is a growing need to utilize poor land for the foundation, earthworks, and construction.

The thickness of the polyester geotextile is reduced when compared to the dry state. The percentage of wet geotextile thickness reduction is higher when set as a strengthener compared to those who are not. It primarily serves as a reinforcing layer in soil that improves the strength of the soil as well as to form a fortified land wall, in order to create the conditions for the construction of dikes and through a soft and poorly supported substrate, or to build the slope of the embankment at a steep angle that could not be done in the case of uninhabited soils that could easily get to the landslide.

Collecting and disposing of atmospheric, underground and other forms of water outside the area of the facility for drainage, the basic functional characteristic of drainage geosynthetics is the ability to conduct water under static or hydraulic loads.

The application of geotextile research confirms the improvement of the quality of the roadway due to the installation of geosynthetics. When building roads on the ground of low load capacity without geotextile, at smaller loads the layer of granular stone material is lost and damaged, so the load from the vehicle is spreading to the surface of the ground larger than the imprints of the wheel. Stone grain material cannot bear the pulling strain and starts to shoot from the lower surface of the layer.

The ground enters the cracks and cavities, and the contact between the stone grains, which then "swims" in the soft material, reduces the strength of the layer and causes the deformation and collapse of the carriage.



*Photo 11. Geotextile display in road construction*

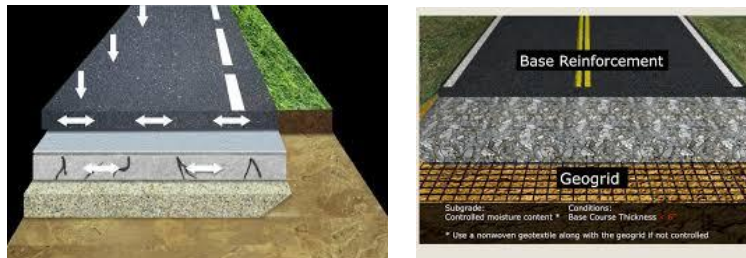

*Photo 12. Geotextile display on layers during road construction*

The greatest mechanical damage to which geotextile is exposed to is when installing or building a construction. The degree of possible damage to the geotextile depends on the size and shape of the aggregate in contact with the geotextile as well as the pressure of the mechanization in the construction on the substrate in which the geotextile is laid. That is why it is necessary to consider this kind of damage and take care of them when designing the works. Mechanical damage that can occur on a geotextile, which is caused by direct contact of the soil and geotextiles under pressure, is the breaking through and splitting of the geotextile contact with the sharp edges of the used raw materials for construction.

Some researchers report that it is better to use stronger reinforcements at longer distances than weaker reinforcement on shorter distances, due to interference between reinforcement when placed too close to one another. The shear strength and ground-geotextile depends on the length of the geotextile, with adequate length and the use of geotextile there are no such problems.

When installing geotextile under the asphalt for the purpose of sealing, geotextile absorbs asphalt and becomes a waterproofing membrane that reduces the vertical flow of water into the pavement structure.

Geocomposites represent a combination of the best features of different materials in such a way that specific applications are solved in an optimal way and with minimal costs. Geocomposites usually consist of at least two geosynthetic materials.

There are five basic functions that can be predicted with a geocomposite: separation, strengthening, filtering, draining and retention.

Types of geocomposites:

- Geosynthetics and Geotextiles: When the geotextile is used on one or both sides of the geogrid, the separation and filtration functions are always satisfied, but the drainage feature greatly improves in comparison with the geotextile.
- Geotextile and geomembrane: geotextile can be on one or both sides of the geomembrane for many purposes. Geotextiles provide more resistance to slip, leakage and friction-related slipping, as well as providing high strength.

Geotextile is profitable because of its quality, durability, longevity, or the lifetime of any construction with it, and therefore it is constantly working on its improvement and new and better geotextile materials and nets.

## 7. High quality and modern geo-technical materials and geogrid

### 7.1. Geotextile



**Photo 13.** *Geotextile* - high quality geotextile, made with modern technology. and perforated cut fiber made of 100% synthetic fibers. Its three-dimensional fiber structure creates numerous holes similar to the maze - pores that resemble the structure of the earth and its hydraulic characteristics.

Versatile material used for numerous functions: single- or multi-layer filters made of geotextile, tiny sandblasted compositions, containers or small-sized pipes and as protection against drainage. Geotextiles non-woven textiles and fine-sanded composites act as separators and filters in hydromechanics, for example, for building embankments, protecting and removing the canal channels and coastal works.

Geotextile pipes are used as protection in port bays; Geotextile containers are successfully used as protection of river and sea slopes. Geotextile has high water permeability, keeps the soil and allows root growth so that the protective structures of the slopes unevenly associate with the natural environment. Geotextile provides protection from demolition of protective walls at waterways, around pillars and longitudinal and transverse hydraulic structures.



## 7.2. Geoweb

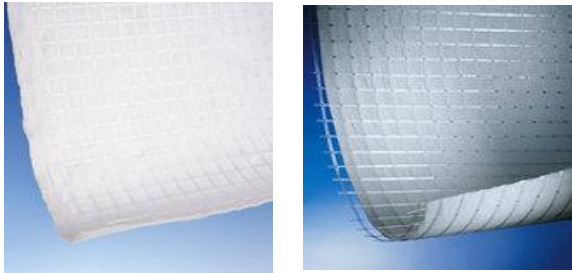

**Photo 14.** *Geoweb*- is a straight-line geometry of the product type Q or R. Its connections are firmly connected, and Geotextile's non-woven component for reinforcing, disassembling and filtering is incorporated. Geoweb combines all the requirements for different features in one single product. For this reason, the main area of use of Geoweb on the weak layers of the earth is just below the surface where besides the strengthening the dismantling properties are necessary also.

This means that the value of breakthrough damage (CBR) is less than 3%. Thus, Geoweb is used to strengthen the basic roads, foundations, access roads, pipes for pipes and in the entire road construction area. The range of available products combines different degrees of tensile strength and non-woven components and covers numerous uses. Thus Geoweb is a multipurpose product for universal use.

## 7.3. HDPE Geomembrane

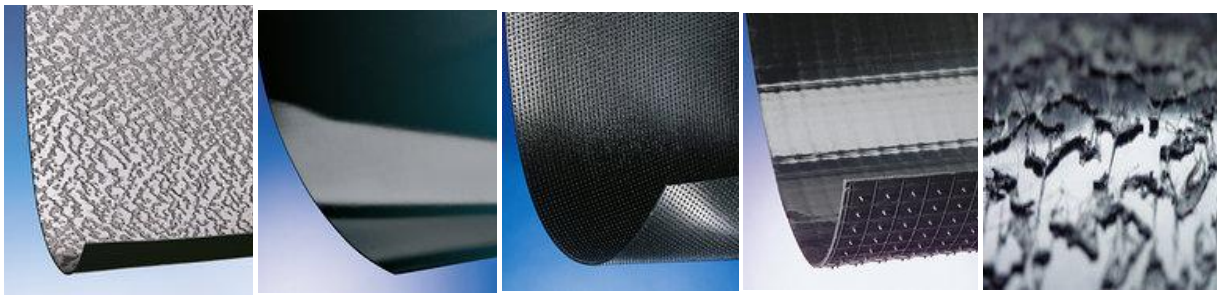

**Photo 15.** *Geomembranes* - made using high density polyethylene (HDPE). HDPE Geomembranes are made in different thicknesses with smooth or structured surfaces..

## 7.4. Geoweb

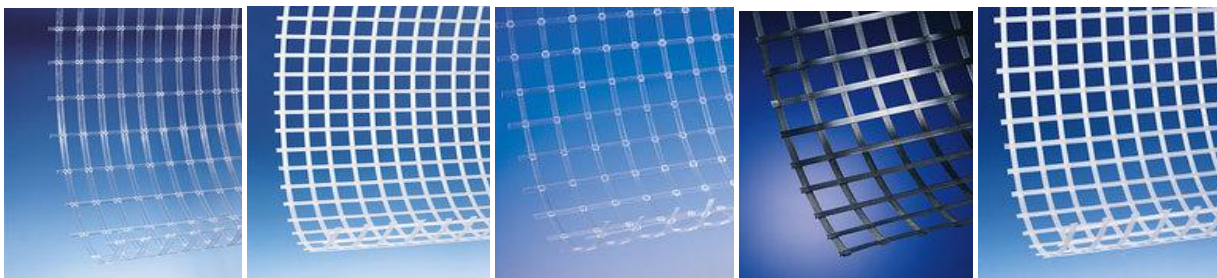

**Photo 16.** *Geoweb* - flat geogrids are made of interlaced rods of extruded polymer (PET or PP). High strength of monolithic welded joints between rods ensures the reinforcement of terrain in all applications in construction, including environmental engineering and infrastructure.

### 7.5 . Drainage foil

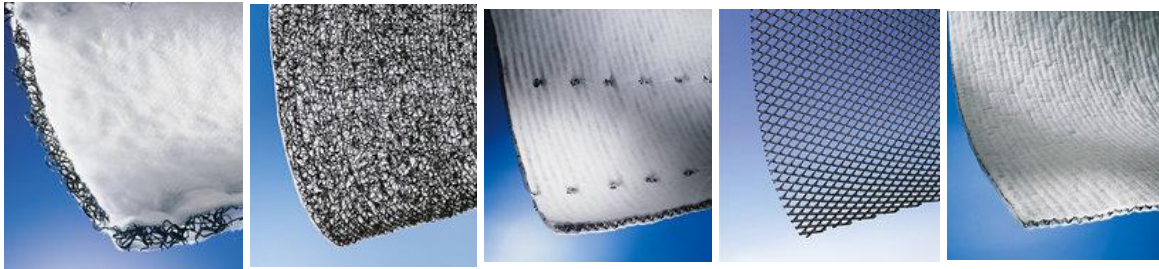

Photo 17. *Drainage foil* - is a three-dimensional drainage system composed of a drainage core and at least one geosynthetic filter layer.

The filtering layer protects the drainage core from entering the soil particle as it allows the movement of gases and water into the interior. All layers are usually bonded together to maintain high shaking resistance. The drainage film solves the problems with the drainage of gases and liquids.

### 7.6. 3D countermeasures web



Photo 18. *3D Countermeasures Web* - is a three-dimensional anti-erosion anti-rust, consisting of a UV stabilized extruded monofilament polymer core similar to the maze. 3D countermeasures web controls surface erosion and helps to strengthen the root plant area. Countermeasures rogos are used for the protection of slopes and soil in the construction of roads, landscaping and communal works. In the area of waterway engineering, the 3D countermeasures web is used on flooded planes and hills. It prevents slipping, rinsing of the soil and upper part of the earth, while at the same time allowing rapid vegetation growth. In the case of severe floods and water courses, the 3D countermeasures web reinforcement capacity prevents the erosion of normally sensitive vegetation. When vegetation rises 3D countermeasures web reduces swelling speed by increasing infiltration and reducing water flow. 3D countermeasures web immediately adjacent to waterways protects the dams from rinsing the water flow.

## 8. CONCLUSION

Geotextiles and geosynthetics have emerged as a necessary need for the industry, first of all, and the product of science, as a response and solution to major problems in the construction of roads, embankments, dams and helps in general even in environmental protection, for this reason, their quality and improvement in use.

In this paper we described the characteristics of geotextile materials and its application, because demand and interest for it are constantly increasing, geosynthetics allows us to provide an appropriate solution for all possible construction problems, on the very ground where textiles are more and more represented, and in this way it also affects the quality of construction. The most widely used geosynthetics is geotextile, and it meets most of the requirements for the formation of materials on the ground, and today it is impossible to imagine a quality and safe construction without a well-insured and well-equipped base, which incorporates geotextiles.

With different geosynthetic products, geotextiles represent materials that can be used in the widest spectrum. Geosynthetics are, in most cases, directed from materials that are synthetic polymers in their base. Plastic mass is a group of materials of organic origin consisting of connective polymeric components and various additives, such as: hardeners, plasticizers, stabilizers, pigments, their properties, use, how much they are used and where they are used. What are their advantages and disadvantages, quality, use, price, mechanical characteristics. Different types of new generations of geotextiles are presented, their influence and position, which are explained in detail, and all the reasons why there is so much interest in geosynthetics, that is geotextile materials and their impact, because they are necessary and to the same extent required and used.

## 9. REFERENCES

- [1] Internet - [http://kotonteks.hr/index.php?content=podrucja\\_rada](http://kotonteks.hr/index.php?content=podrucja_rada)
- [2] Internet - <http://www.dupontdenemours.fr>
- [3] Internet - <http://www.geotekstili.com/o-geotekstilima.asp>
- [4] Internet - <http://www.buildmagazin.com/index.aspx>
- [5] Internet - <https://www.asglatex.com/start.html>
- [6] Lam, H.L., Composite Manufacturing with the Braidtrusion Process, 2001, MS Thesis, Drexel University 21.Hampton, F.P., Cyclic Behavior, Development, and Characteristics of a Ductile Hybrid Fiber Reinforced Polymer (DHFRP) Reinforced Concrete Members, 2004, PhD Thesis, Drexel University
- [7] Hampton, F. P. , Harry, H. G., and Ko, F. K., ., Low-Cycle Fatigue Strength Of A Ductile Hybrid Fiber Reinforced Polymer Bar For Earthquake Resistant Concrete Structures, Proceedings, ICCM 14, San Diego, CA., Paper ID: 1295, July 14-18, 2004
- [8] Ko, F.K., Nanofiber Technology: Bridging the Gap between Nano and Macro World”, in NATO ASI on Nanoengineered Nanofibrous Materials, 2003, Anatalia, Turkey, Kluwer Academic Publishers
- [9] Formhals, A., US Patent # 1,975,504, 1934. Doshi, J., D. Reneker, H., J. Electrost. 1995, 35, 151 Gibson, P. W., Schreuder-Gibson, H. L., Riven, D., AIChE J. 1999, 45, 190
- [10] Ko, F.K., El-Aufy, A., Lam, H.L., and MacDiarmid, A.G., “Electrostatically Generated Nanofibers for Wearable Electronics”, in Wearable Electronics, Edited by X.M. Tao, Woodhead, 2004

## AIR PERMEABILITY AS CHARACTERISTIC OF KNITWEAR INTENDED FOR ACTIVE WEAR

\*Tatjana Šarac, Nenad Ćirković, Sandra Stojanović, Nataša Radmanovac

Faculty of Technology, Leskovac  
tangerine.art83@gmail.com

### ABSTRACT

*With the development of technology and an increase in living standards, requirements related to textile materials are changing. Today, is expected from clothing to complete a set of requirements, primarily related to their purpose. These requirements firstly relate to their functionality, comfort and aesthetics. This refers mostly to clothing intended for sport activities. When projecting active wear, it is necessary to pay attention to its physiological characteristics, such as heat properties, humidity transfer and air permeability through the system; body - clothing - environment. These characteristics depend on the applied raw materials, types of yarn, applied interlacing, etc. However, layered dressing should be taken into account during sports activities (for example underwear and upperwear). In this case, when designing active wear, all the materials through which the transport of moisture or air is carried out, and the performance of the clothes will depend on the combinations of all the materials constituting the system.*

*This paper presents the results of air permeability, both for individual knitwear of different raw materials, structural characteristics and different purposes (for laundry, t-shirts and upper garments), as well as for combinations of these materials in cases of layered dressing.*

*The obtained results can be used in projecting active wear and to investigate the thermo-physiological properties of combination of materials for active wear.*

**Key words:** *physiological characteristics, air permeability, knitwear, active wear*

### INTRODUCTION

With the development of technology and an increase in living standards, market requirements related to textile materials are also changing, depending on their purpose. Today, in addition to aesthetics and endurance (the tendency to recover after the effect of force), comfort is required which includes physical, sensory and thermal-physical comfort. When projecting active wear, it is necessary to pay attention to its physiological characteristics, such as heat properties, humidity transfer and air permeability through the system; body - clothing - environment.

It is known that the type of fibers, the properties of the yarn, the structure of the textile material and finishing have an impact on the comfort of the garment. It is known that the type of fibers, the properties of the yarn, the structure of the textile material and finishing have an impact on the comfort of the garment. In addition to high elasticity, fabrics have great freedom of movement, but they also have the ability to transfer moisture from the human body to the environment. Therefore, knitwear is suitable for making active wear and underwear [1].

Air permeability of textile materials is an important factor in the comfort of textile materials because it plays a role in transporting moisture from the surface of the skin to the atmosphere. The flow of air through knitted fabric is mainly influenced by the characteristics of knitted fabrics. Diameter of the yarn, the number of loops per unit area, are the main factors that influence the porosity of the knit.

The porosity of the knitwear is associated with its main characteristics, such as air permeability, water vapour permeability, etc. [3, 4].

When designing clothes for sports and, in general, physical activities, layered dressing should be considered.

Often, depending on weather conditions, athletes and recreational wearers wear more layers of clothing over the body. In this case, it is necessary to anticipate and examine materials that comprise a clothing system.

In examining the permeability of air from the body through layers of material into the environment, the characteristics of the individual materials and their properties are important.

## MATERIALS AND METHODS

Experiments were carried out on knitwear of different raw materials, structural characteristics and different purposes (for underwear, jerseys and trainers), as well as for combinations of these materials in cases of layered dressing. Knitwear are made from 100% cotton and 100% polyester, in plain jersey (right-left), the right-left lining patterns, right-right patent 1:1 and the interlock 1:1 pattern, the group of interlock and the tricot-satin pattern from the group of the warp knitting patterns. Structural characteristics of knitwear are shown in table 1

*Table 1: Structural parameters of knitted fabrics*

Sample number	Raw material	Pattern	$T_t$ (tex)	$D_h$ (cm <sup>-1</sup> )	$D_v$ (cm <sup>-1</sup> )	$D_t$ (cm <sup>-1</sup> )	$T$ (mm)	$C$	$l$ (mm)	$Q$ (g·m <sup>-2</sup> )	$\gamma_k$ (g·cm <sup>-3</sup> )
S.1	Co	DL	21.3	14.5	19	275.5	0.56	0.763	2.62	154.06	0.275
S.2	Co	DL	20.64	15	20.5	307.5	0.60	0.732	2.61	165.42	0.276
S.3	Co	DL	22.14	16	22	352	0.54	0.727	2.27	177.07	0.327
S.4	Co	DL <sub>fu</sub> (1:3)	10.6 wo 44.78 fu	14.2	19	269.8	0.79	0.747	4.42	256.26	0.324
S.5	Co	DL <sub>fu,r</sub> (1:3)	16.23 wo 86.15 fu	11.5	15	172.5	1.50	0.767	3.47	299.22	0.199
S.9	PES	gr. I	9.53	15	19	570	0.45	0.789	2.26	122.94	0.273
S.10	PES	gr. I	9.51	18.5	16.5	610.5	0.45	1.121	2.44	141.54	0.314
S.11	PES	gr. I	9.27	19.2	17.2	660.48	0.46	1.116	2.60	159.18	0.346
S.12	PES	Tr-Sa	6.93	16.3	14.2	231.46	0.74	1.148	14.66 tr 7.77 sa	199.49	0.269
S.13	PES	Tr-Sa	10.18	16.3	15.5	252.65	0.82	1.052	2.97 tr 4.95 sa	203.75	0.248

$T_t$  – linear mass of yarns,  $D_h$  – loop horizontal density,  $D_v$  – loop vertical density,  $D_t$  – total loop density on 1 cm<sup>2</sup>,  $T$  – thickness of knitwear,  $C$  – density ratio coefficient,  $l$  – loop length,  $Q$  – surface mass of knitwear,  $\gamma_k$  – volume mass of knitwear

Knitwear is designed for clothes for sports activities, intended to be worn next to the body (for underwear 1, 2, 3) as well as knitwear designed for the manufacture of upper clothes (for trainers 4, 5, 12 and 13, for shorts and jerseys 9, 10 and 11). Table 2 shows the tested combinations of knitted fabrics.

*Table 2: Tested combinations of knitted fabrics*

Sample code	Combinations of knitwear: underwear - trainers				Combinations of knitwear: underwear - jerseys		
	1-4	1-5	1-12	1-13	1-9	1-10	1-11
	2-4	2-5	2-12	2-13	2-9	2-10	2-11
	3-4	3-5	3-12	3-13	3-9	3-10	3-11

The air permeability represents the amount of air (cm<sup>3</sup>) that passes through the textile material of 1 cm<sup>2</sup>, for 1 s and at a certain pressure  $p$  (Pa):

$$P_v = \frac{V}{A \cdot t} \text{ (cm}^3 \cdot \text{cm}^{-2} \cdot \text{s}^{-1}\text{)}$$

where is:

$P_v$  - air permeability (cm<sup>3</sup> · cm<sup>-2</sup> · s<sup>-1</sup>),

$V$  - amount of air leakage (cm<sup>3</sup>),

$A$  - working space of the material (cm<sup>2</sup>)

$t$  - time (s).

Air permeability can be expressed in the following units: cm · s<sup>-1</sup>, l · cm<sup>-2</sup> · s<sup>-1</sup>, l · m<sup>-2</sup> · s<sup>-1</sup>, dm<sup>3</sup> · s<sup>-1</sup>, etc .

Testing of the air permeability of the knitted fabrics was carried out according to ISO 9237:1995, Textiles - Determination of the permeability of fabrics to air.

## RESULT AND DISCUSSION

Figure 1 shows the values of air permeability through single tested knitted fabrics. Figure 2 shows the values of air permeability through combinations of knitted fabrics, underwear - trainers. Figure 3 shows the values of air permeability through combinations of knitted underwear - jersays. The mean values of the air permeability test on the face and back of the knitted fabric are shown.

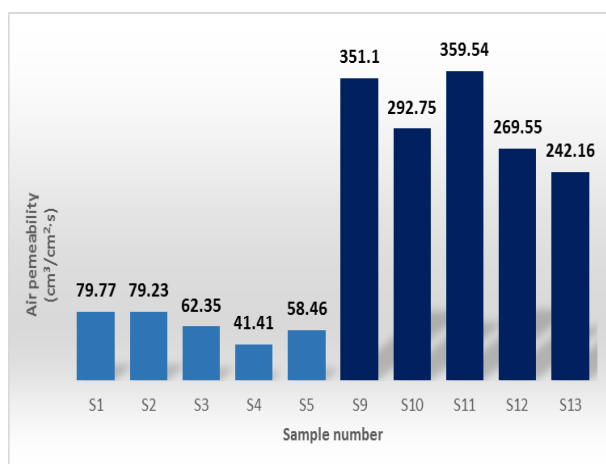

Figure 1: Values of air permeability through single tested knitwear

From Figure 1, it can be concluded that polyester knitwear (S9, S10, S11, S12 and S13) have significantly higher air permeability values than cotton knitwear (S1, S2, S3, S4, S5).

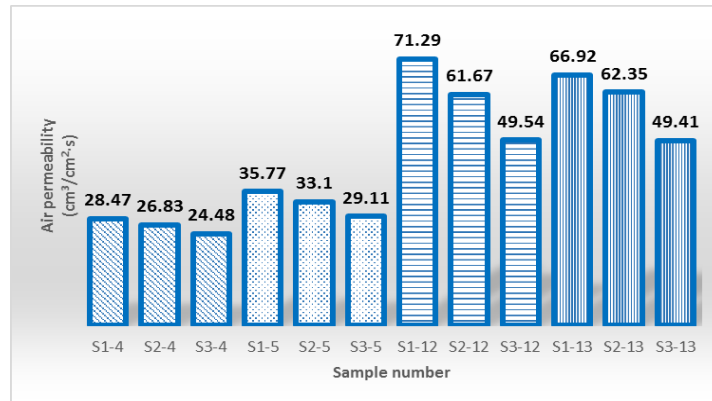

Figure 2: Values of air permeability through combinations of knitwear: underwear – trainers

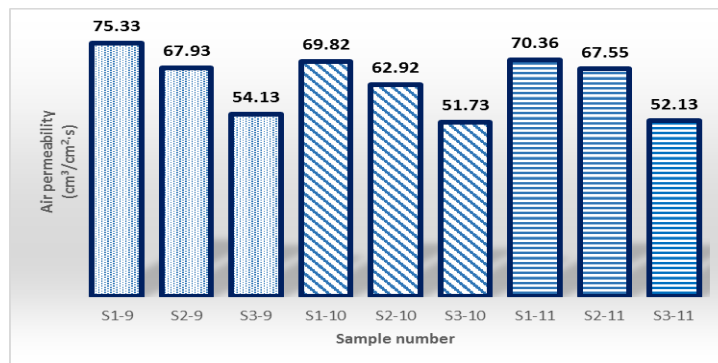

Figure 3: Values of air permeability through combinations of knitwear: underwear – jerseys

In the examination of air permeability through combinations of knitted fabrics, were tested knitwear S1, S2 and S3, designed for laundry in combinations with knitwear S4, S5, S12 and S13 intended for trainers and knitwear S9, S10 and S 11 designed for jerseys. From Figures 2 and 3, it is firstly observed that when combining knitwear for laundry with all the other knitted fabrics, the smallest air permeability value has combinations with knitwear S3, then S2 and the highest values are recorded by combining with knitwear S1.

The same case of air permeability was observed when testing single knitwear in samples S1, S2 and S3. In Table 1, it can be seen that the sample S3 has the highest vertical and horizontal loop density, as well as total loop density, then sample S2 and at the end sample S1. Based on this, it can be concluded that the density of knitwear has an impact on the permeability of the air through a single and a combination of knitted fabrics, while parameters such as thickness and surface mass have smaller impact.

From Figure 2, it can be concluded that the combinations of two cotton knitwear have less air permeability than the combinations of cotton knitwear with PES knitted fabrics. From Figures 2 and 3 it can be seen that combinations of knitwear for laundry and jerseys have higher air permeability values than combinations of knitwear for underwear. Such results are expected in relation to the purpose of knitwear. Knitwear for trainers has a longer linear mass of the yarn, the density of the loop and therefore have a higher surface mass and thickness, which affects the lower air permeability.

*Table 3: Assessment of the ability of air permeability*

Combinations of knitwear: underwear – trainers				Combinations of knitwear: underwear – jerseys			
Code	From face to back (cm <sup>3</sup> /cm <sup>2</sup> ·s)	From back to face (cm <sup>3</sup> /cm <sup>2</sup> ·s)	Mark	Code	From face to back (cm <sup>3</sup> /cm <sup>2</sup> ·s)	From back to face (cm <sup>3</sup> /cm <sup>2</sup> ·s)	Mark
1-4	27.4	29.56	+	1-9	79.62	71.04	-
2-4	26.4	27.26	+	2-9	70.035	65.815	-
3-4	24.33	24.63	+	3-9	57.82	50.425	-
1-5	36.09	35.45	-	1-10	71.36	68.28	-
2-5	33.23	32.8	-	2-10	63.445	62.39	-
3-5	29.35	28.84	-	3-10	54.375	49.09	-
1-12	71.27	71.32	+	1-11	72.21	68.505	-
2-12	64.54	58.8	-	2-11	68.455	66.63	-
3-12	53.89	45.19	-	3-11	55.21	49.05	-
1-13	67.46	66.37	-				
2-13	64.09	60.61	-				
3-13	52.61	46.19	-				

For the tested combinations of knitwear, marks are given of the ability of the samples to pass through the air.

If higher values of permeability of the back regards to the face of the combination of knitwear are recorded, the sample is estimated by the mark -, and vice versa, if a higher permeability of the air on the face regards to the back is recorded the sample is estimated by the mark +. Table 3 shows assessment of the ability of air permeability.

In most cases, the samples showed a better ability to pass the air from the face to the face, but from the face to the back. However, the obtained air permeability values from the face and back are indicative that the differences in the air volume are insignificant on the back side regards of the face of the combination of knitwear.

## CONCLUSION

Since cloths represents a certain barrier to the free exchange of energy of a man with his environment, it is necessary that textile materials have physical properties that ensure the comfort of the material, primarily their ability to leak water vapour and air. Air permeability through knitted fabric can affect the comfort of the clothes that are made from it. Knitted material that has good air permeability generally has good water permeability in either steam or liquid form. Therefore, evaporation and moisture are associated with the permeability of the air.

Based on the results obtained in this paper, samples of cotton knitwear have lower air permeability values compared to polyester samples. When combining two cotton knitwear, lower air permeability values are also obtained in relation to combinations of cotton knitted fabrics with polyester knitwear. The permeability of air through combinations of knitted fabrics has the greatest influence on the raw material composition, the density of the knit, as well as the surface weight of the knitted fabric.

In spite of the fact that the technology of making materials for active wear and various physical activities has made great progress in the design of "smart" textiles, research in this paper that includes the behavior of conventional knitted materials in sports activities can serve for further research into the physiological characteristics of combinations of different textile materials in case of layered dressing.



## REFERENCES

- [1] Machich S., Thakur A K P & R (2012), Functional properties of bamboo/polyester blended knitted apparel fabrics, *Indian Journal of Fibre & Textile*; 37, 231-237.
- [2] Onofrei E., Rocha A. M., Cotarino A. (2011), The Influence of Knitted Fabrics' Structure on the Thermal and Moisture Management Properties, *Journal of Engineered Fibers and Fabrics*, (6) 4, 10-22.
- [3] Ogulata R. T., Mavruz S. (2010), Investigation of Porosity and Air Permeability Values of Plain Knitted Fabrics, *FIBRES & TEXTILES in Eastern Europe*, 5 (82), 71-75
- [4] Ćirković N., Đorđević S., Trajković D., Radmanovac N. (2014), Fiziološke karakteristike pletenina kao faktor izbora materijala za odeću, *Savremene tehnologije*, 2(3), 76-84.
- [5] Čepujnoska V., Čortaševa S., Metodi za ocenakana pokazatelite na kvalietetot na tekstilnite materijali, Univerzitet "Kiril i Metodij" Skopje, 1991.
- [6] Xiao X., Jinlian H., Zeng X., Long A. (2015), Through thikness air permeability of wovwn fabric under low pressure vompresion, *Textile research journal*,85 (16), 1 – 11.
- [7] Ozcelik G., Cay A., Kirtay E. (2007), A study of thermal properties of textured knitted fabrics, *FIBRES & TEXTILES in Eastern Europe*, 1 (60)
- [8] Suganthi T, Senthilkumar P, Dipika V. (2017), Thermal Comfort Properties of a Bi-layer Knitted Fabric Structure for Volleyball Sportswear, *FIBRES & TEXTILES in Eastern Europe*, 25, 1(121), 75-80

**This paper is a part of the research project No. TR – 34020, financed by the Ministry of Education, Science and Technological Development of the Republic of Serebia.**

## TESTING METHODS OF RESISTANCE FOR BASE CRYMPLE OF KNITTED AND LAMINATED MATERIALS FOR CAR UPHOLSTERY

**D. Joksimović, V. Petrović, A. Milosavljević, S. Sindelić, N. Petrović**

**Technical Faculty "Mihajlo Pupin", Zrenjanin,**

Đure Đakovića bb, 23000 Zrenjanin

**Faculty of Technology Leskovac, University of Nis - The scholarship holder of the Ministry**

email: danka.joksimovic21@gmail.com

### ABSTRACT

*The paper cause is to explain the method of laminating materials, their use as well as the possibility of increasing resistance to materials used for car seat covers. In order to increase the resistance of the material to wrinkling in research they compared not laminated and laminated materials in order to obtain as much resistance to wrinkling. In addition to the obtained results, the aim of the research was to prove that the structural properties of the sample material didn't directly affect the recovery of the wrinkled material*

**Key words:** laminating, materials, knitwear, resistance, crunching, seat covers

### INTRODUCTION

Mobility is a basic requirement for all human activities in any category : business or entertainment. Today, people spend more time in their cars, travel to long distances, and work at a daily or weekly level. Due to its constant use, there is a high demand for seat cover materials. Obviously, the automotive industry is the largest user of technical textiles, which can be seen in the fact that about 20 kg of material is used in each of 45 million cars every year worldwide. On 20 kg of textiles, in the average car they make approximately 3.5 kg of seat covers, 4.5 kg of etisone and 12 kg of other parts of the interior and the tires [1,2]

Among the methods used for the production of seat covering materials, the base knitting method is of great importance. This is due to the fact that for the production of these materials knitting on the warp is very effective, because it achieves high performance knitwear at a low prices and relatively low weight. [3]

The seat covers have two purposes. The first purpose is that the consumer wants to prevent the seat from demaging, while the other is that the consumer wants to cover the worn up covers. Whether it's first or second purpose, the most important is that the covers are strong, mold-resistant, have good dimensional stability, can be washed, and resistant to wrinkling. Wrinkling falls into a three-dimensional version of the fold, and it happens when the knitted fabric is forced to develop a double curve that leads to permanent deformation. [4]

Wrinkling of material depends on the type of fibers, the bending properties, diameter of the fibers, spinning, thickness. The wrinkle also depends on the stiffness of the material, and the elastic recovery. By the action of the wrinkling force, the elements in fibers move by creating a connection in some other part of the element, creating irreversible deformation.

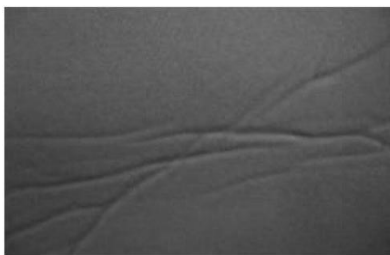

Figure 1: Example on wrinkled seat cover

In order to improve the knitting fabric for car seat covers, testes needed to be done, taking samples of ten knitted fabrics made on the same warp knitting machine, five samples were laminated and the other five weren't. Lamination is the connection of two layers of knitted fabric used for interior elements of the car. Third layer usually is usually glue, but sometimes the third material is used alone as a glue using flame lamination. [1]:

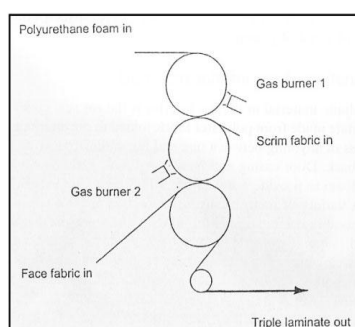

Figure 2: Laminated material with plamen [1]

Flame lamination works by the gas flame burner 1 melts the surface of the foam, which was until then glue for the twisted fabric. On the other hand, the burner 2 melts the second surface of the foam, where it acts like glue for the face of the fabric. Therefore, it can be concluded that three separate materials were merged into one triple laminate fabric. [5] The fabric lamination process becomes three-layer. The top or top layer, also referred to as non-laminated knitwear, is knitted of 100% polyester. The middle layer is a foam layer and was made of polyurethane with 2mm thickness and 28kg density / m<sup>3</sup>. The lower or last layer is used as a knit fabric and is knitted of 100% polyester.



Figure 3: Lower layer of knitting [3]

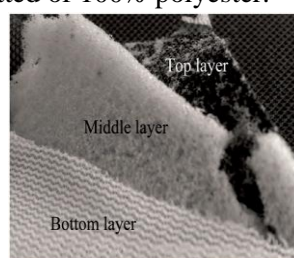

Figure 4: Laminated fabric in layers [3]

In order to improve resistance to wrinkling of knitwear, today we use softeners, which are very popular, and serve to reduce wrinkling.. [6]

By using chemical softeners, knitwear can become softer, get little roughness, get more flexibil and become better draping and flexibility properties . Other than that, silicone softeners provide very high softness, elasticity, high material recovery, résistance to damage and tearing. [7] Because of heat effect on the fabric, the bond between the macromolecule and the crystalline bond of the fibers is broke, so the fiber passes from a solid to a soft elastic state, then it reaches the internal voltage of fiber that can be adjusted as needed and finally newly formed internal voltage the effect of energy is a shifted and broken link that is formed in accordance with the necessary holding, shape, and firmness. [8]

## MATERIALS AND METHODS

Samples of not laminated material are knitted on the same machine. Knitting is done from 100% PES yarn (110 days and 36 filaments) according to the following process: Knitting, first fixing at 190°C for 10s, second fixing at 200°C for another 10s. In the second method, a 2% polyethylene silicone water based softener is added to the material during the process of colouring. In the third method, 20% more elastic yarn was added for knitting. In the fourth method, knitwear is different from the basic by skipping the first fixing process. The last method is similar to the second one, but this time the softener is added while the fabric passes over the frame after the colouring process. All methods are marked as A, B, C, D, E

*Table 1: Struktural properties of samples of knitiwear*

Do not laminated knitwear							Laminated knitwear	
The top layer of knitwear				Lower layer of knitwear				
Samples of knitwear	Thickness (mm)	Weight (g/m <sup>2</sup> )	Loop Density (cm <sup>2</sup> )	Thickness (mm)	Weight (g/m <sup>2</sup> )	Loop Density (cm <sup>2</sup> )	Thickness (mm)	Weight (g/m <sup>2</sup> )
A	0,68	240	182	0,30	51,5	130	3,82	415
B	0,64	229	182	0,30	51,5	130	4,37	408
C	0,55	230	182	0,30	51,5	130	3,77	428
D	0,66	259	182	0,30	51,5	130	4,52	435
E	0,64	231	182	0,30	51,5	130	4,58	470

Before testing, knitwear will be conditioned under standard conditions in accordance with ASTM D 1776-2009 standard [9] The test will be performed according to the AATCC test method 128 - 1999 [10] on the AATCC tester for recovery of wrinkles.



*Figure 5: AATCC machine [11]*

The principle of the method is to challenge wrinkling on the knitted fabric under a certain weight on the sample for a certain period of time, and then compare this sample with the table below:

*Table 2: Marks for quality of defined looks [11]*

Marks of quality	Defining of looks
1	Deeply wrinkled look
2	Wrinkled look
3	Medium wrinkled look
4	Lightly wrinkled look
5	Completely smooth surface



Figure 6: AATCC Example of quality of recovery of wrinkled knitwear [11]

Before testing, as already mentioned, a knit sample needs to be pre-condition in the laboratory for 24 hours. However, in this study, the effect of the evaluation was carried out immediately (as soon as the fabrics were removed from the appliance) after 30 minutes of rest under standard conditions in the laboratory and after 24 hours of relaxation (the samples were left on the laboratory hanger) because when we do estimation of level of wrinkling after 24 hours the difference is hard to notice. For this reason, it is considered that the 24h will be a very long period for simulation on real car seats because cars are usually used after a few hours, without waiting for so long time. [3]

## RESULTS AND DISCUSSION

In testing, it was taken into account that there were three intervals according to which the recovery of laminated and non-laminated materials could be observed. In picture 7, the recovery of not laminated material after the wrinkling at the moment, after 30 minutes and after 24 hours.

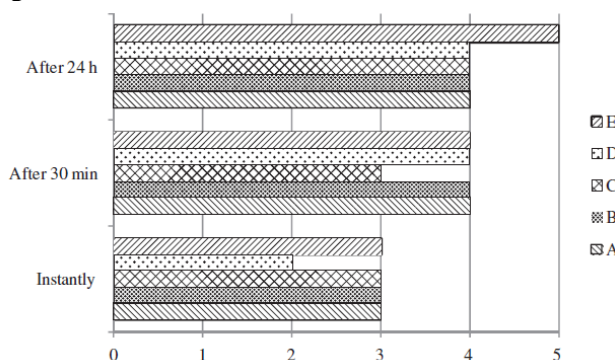

Figure 7: Resistance on wrinkling of not laminated fabrics [3]

After testing, it can be seen in the figure that the recovery of wrinkles was moderate as soon as the weight was raised and after 30 minutes and after 24 hours, which indicates that the wrinkling recovery was increased for one level.

- In the picture, the resistance of the basic knitwear and knitwear B is at the same level that shows that addition of a silicone softener during the staining process did not provide better wrinkling resistance.
- Observing the sample C, it can be noticed that there was no change even after 30 minutes and after 24 hours, even though elastic yarns were used in this method.

This shows that the elasticity did not have a significant effect on the anti-wrinkle resistance, and that the reason may be different structural parameters such as the thickness and weight of these materials that are heavier than the basic sample.

- For sample D, deformation is visible right after the wrinkling, more than in the basic sample, which shows that the first fixation prevents material deformation but needs to be applied before painting.

- In sample E, is noticeable significant linear incensement to resistance on wrinkling after 24 h, where the sample is completely smooth.

The conclusion comes up from all methods, the best method is fourth one where silicone softeners are added when crossing the material over the frame, which provides significant wrinkling resistance.

Finding out that mostly used materials for car seat covers are laminated ones, laminated materials are evaluated in the same way as non-laminated materials. The test was carried out under the same conditions where the wrinkling resistance was evaluated in the same manner.

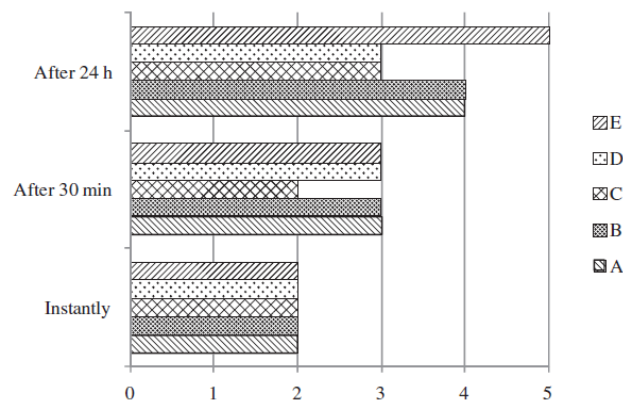

Figure 8: Resistance on wrinkling of laminated fabrics [3]

When looking at Picture 7 and Picture 8, it can be seen that at the initial recovery level at laminated materials is a lot worse than at non-laminated ones. However, after 30 minutes and after 24h, the wrinkle resistance is the same at both laminated and not laminated materials. This result was supported by the process of three-layer lamination of the material, where the thicker ones are with heavier structure. The structure makes wrinkle resistance more difficult. In the laminated sample C, the wrinkle resistance is significantly worse than in the non-laminated material where the wrinkle resistance is the same as in the base sample. From this it is possible to conclude that the elasticity needs to be studied more, because the elastic effect on the upper layer of the material wasn't adequate because it is necessary to increase the elasticity of the lower layer in order to obtain elasticity completely.

## CONCLUSION

This paper presents the testing of the material's resistance on wrinkling in covering of car seats in automotive industry. The goal of the test was to try to improve wrinkle resistance of car seat covers. Also, the goal of this study was to compare the resistance to wrinkling of laminated and non-laminated materials, and to conclude that the structural properties don't directly affect the process of recovery of wrinkled material. Because of this, the basic material was made in conventional way of popular production, and the other samples were treated with various treatments in order to choose the best method for wrinkle resistance of the material. After the treatments with adding silicone softeners where done, it was concluded that they didn't add enough wrinkle resistance to the material. Also, by adding more elastic yarns it is possible to obtain the desired resistance, but in case that the additional yarns are not adequate (only on the top layer), this method doesn't have enough influence on increasing the wrinkle resistance. Since the application of the first fixation prevents permanent deformation of the material, it is necessary to apply the fixation to the material before painting.

Out of all methods, the best one was the fourth one, where the material that crossed the frame after colouring process was treated with silicone softener. In this method we got the best results of wrinkle resistance.. As shown in the table: All structural parameters of knitwear were the same except for the thickness of the sample C after the applied methods. For this reason, it can be said that the structural properties of the fabric sample do not directly affect the recovery of the wrinkled material.

## REFERENCE

- [1] Fung W and Hardcastle M. Textiles in automotive engineering. Cambridge, England, UK: The Textile Institute, Wood head Publishing Limited, 2001.
- [2] Degirmenci Z and C, elik N. An investigation on improving the wrinkle recovery of warp knitted automobile upholstery fabric. In: 4th international technical textile congress, Istanbul, Turkey, 16–18 May 2010, p. 117.
- [3] Zülleyha Degirmenci 1 and Nihat C, elik2, The effects of selected improving methods on wrinkle resistance of warp knitted and laminated car seat cover fabrics, 2014, Vol. 44(2) 245–256
- [4] Binjie X and Hu J. Fabric testing, Chapter 6. Cambridge, England, UK: Wood head Publishing Limited, 2008.
- [5] Schinder WD and Hauser PJ. Chemical finishing of textiles, Chapter 3, Cambridge, England: Woodhead Publishing Ltd., 2006
- [6] Mavinkurve AA, Ji L and Maria Krings LH. Compound and method of improving wrinkle resistance in fabrics, and device for containing such a compound. Patent Application 0083025 A1, USA, 2007.
- [7] Schinder WD and Hauser PJ. Chemical finishing of textiles, Chapter 3, Cambridge, England: Woodhead Publishing Ltd., 2006.
- [8] Tarakçoğlu I. Tekstil terbiyesi ve makinaları. \_Izmir, Turkey: University of Ege, Textile and Ready Made Research and Application Center, 1996.
- [9] ASTM D 1776–08. Standard practice for conditioning and testing textiles 1 standard, 2009.
- [10] AATCC Test Method 128 wrinkle recovery of fabrics-appearance method standard, 1999.
- [11] SDLATLAS. Available at: <http://www.sdlatlas.com/product/192/AATCC-Wrinkle-Recovery-Tester>, (2013, accessed 11 January 2013).

## ANALYSIS OF TEXTURED PES FILAMENT YARN CHARACTERISTICS IN THE ZONE OF ELASTIC DEFORMATIONS

Jovana Stepanovic, Dusan Trajkovic, Nataša Radmanovac, Jovan Stepanovic

Faculty of Technology, University of Nis,  
Bulevar Oslobođenja 124, Leskovac, Serbia  
email: [jovan@tf.ni.ac.rs](mailto:jovan@tf.ni.ac.rs)

### ABSTRACT

*The properties of textured POY PES multifilament yarns are conditioned by texturing temperature, texturing speed, stretching degree and by the ratio of disc peripheral speed and yarn speed. The properties of textured PES filament yarns are presented in the paper as the results of characteristics analysis in the zone of elastic deformations. Thereby attention is focused on crimping and elasticity of yarns produced at various texturing speeds and first heater temperature. Beside analysis of elasticity limit a new method for defining crimping limits is proposed. The method is based on the flow analysis of the force - elongation function of textured yarns.*

**Key words:** *texturing, crimping, elasticity, force, elongation, work.*

### INTRODUCTION

During texturing process the yarn is exposed to the impact of high temperatures and tensile and torsion forces affecting the yarn structure and hence its properties [1, 2, 3]. Using HT heaters (high temperature contactless heaters) steps have been taken to improve texturing process with the aim to increase productivity while maintaining the quality of textured yarn. Usually, heater temperatures are 380°C to 420°C for texturing PET filament of 167 dtex fineness at texturing speed of 1000 m/min. These temperatures are well above softening temperatures (230 - 240°C). However, since the yarn retention time in the heater is too short the yarn temperature at the exit is about 210°C, which is normal processing temperature for this type of yarns. Increasing heater temperature causes a more intense heating of yarn requiring shorter retention time in the heater and therefore temperature decrease over the thread cross section [4, 5].

A considerable number of works is found in literature on the analysis of the properties of textured stretched polyester filament yarn (FOY - Fully Oriented Yarn) characterized by a stable structure [6, 7, 8]. The works studying properties of textured yarns made of partially oriented polyester filament (POY - Partially Oriented Yarn) mostly analyze the yarns produced under laboratory conditions [9, 10, 11]. The investigations of [12] textured multifilament yarns crimping produced in industrial conditions [13, 14] show that the optimum texturing parameters must be chosen as a compromise solution.

Since textured filament yarns created from POY PES filaments and produced on machines with HT heaters are not sufficiently investigated, in the scope of this work shown are investigations of the effect of some process parameters on the properties of textured yarns in the zone of elastic deformations. Elastic deformation zone ends at elasticity limit and represents unexplored area. The zone also involves crimping of textured yarns which is one of the key characteristics of these yarns. Elasticity limit and crimping limit are defined on the basis of flow analysis of force-elongation function of the yarns. The results obtained can indicate the effect of these parameters on some properties of textured yarns and also to contribute to development of a new method for textured yarn crimping characterization.



## MATERIAL AND METHODS

Preparation of experimental material was done under industrial conditions on a machine for stretching texturing with high temperature heater: FTF-15 (ICBT, France).

Technical characteristics of the machine are: maximum texturing speed - 1500 m/min; the length of the first heater - 1.050 m; the length of the second heater - 1.60 m; cooling zone: 1.24 m; friction aggregate - ICBT aggregate 1-5-1; working PU discs (5 pcs); C profile.

Prepared were samples of textured PES yarn of fineness 167f36×1 dtex, of POY PES multifilament fineness 278f36×1 dtex, from the manufacturer TWD Fibers (Germany). POY polyester filament (poly (ethylene terephthalate)) used in this investigation was partially oriented with very low crystallinity degree (less than 5%), so that its structure and properties could be changed to a great extent by changing texturing process parameters.

In the texturing process of yarns various temperatures of the first heater were used (350°C, 400°C and 450°C) at constant temperature of the second heater (180°C), then at different texturing speeds (500 m/min to 1100 m/min), with the stretching degree of 1.665 and at D/Y ratio of 2.20.

For determination of mechanical characteristics of experimental materials, automatic dynamometer USTER TENSORAPID 4 was used. Using the “USTER TENSORAPID 4” software the results obtained were shown in the form of typical curves (Figure 1).

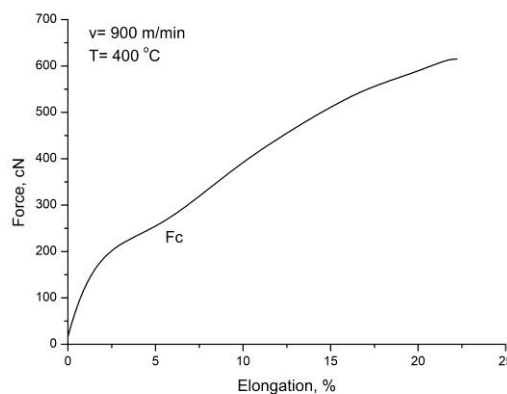

**Figure 1.** Typical  $F$ - $\varepsilon$  curves of filament PES yarn

Crimping and elasticity limits of textured PES yarns were determined by analyzing  $F(\varepsilon)$  function. Figure 2 shows the first and the second derivative of  $F(\varepsilon)$  function, on the basis of which force intensities and the values of relative elongation at the crimping limit and at the elasticity limit of analyzed texture PES yarns were determined.

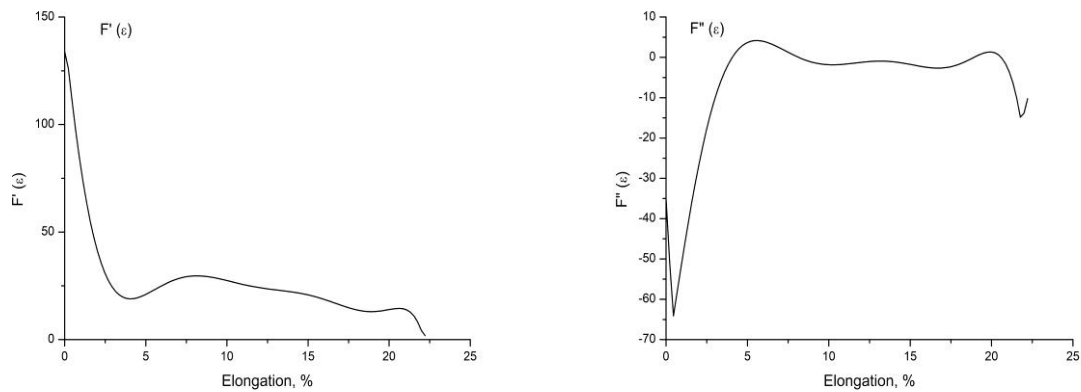
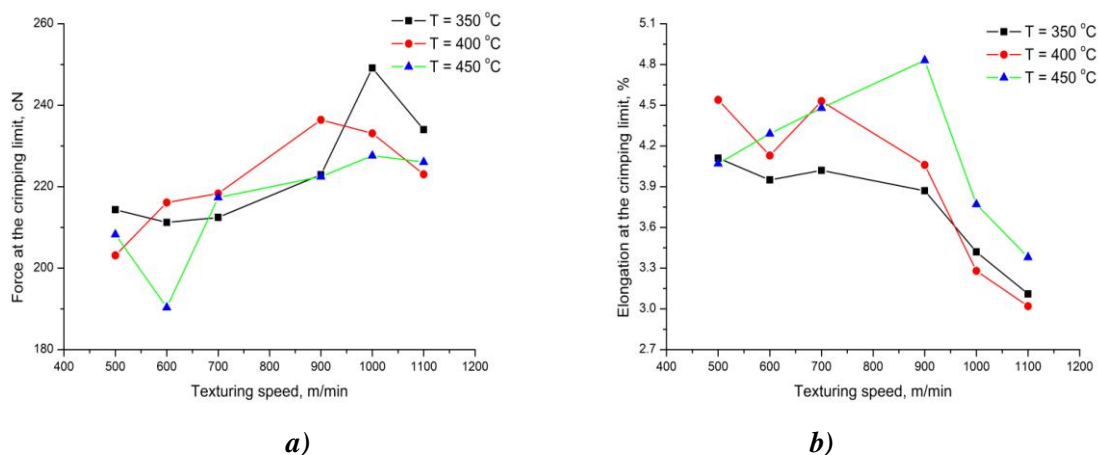

**Figure 2.** The first  $F'(\epsilon)$  and the second  $F''(\epsilon)$  derivative of the function

Further, using the results obtained determined was the work of the force to the crimping limit and the work of the force to elasticity limit. The work of the force was defined by the surface under force-elongation curve to the limits defined by the flow analysis of that function.

## RESULTS AND DISCUSSION

During yarn stretching, first the straightening of crimps, formed in the texturing process takes place. In the beginning, a higher curve slope can be noticed, due to faster force increase with regard to elongation of textured PES yarn. This can be the effect of monofilament interlacing which appears in the process of false spinning, because not all monofilaments are heated to the same temperature due to the position in multifilament yarn and therefore do not receive the same torsion energy. During further stretching, releasing of interlaced monofilaments takes place and to the point  $F_c$  (the point of crimp straightening point) decline of the slope of force - elongation function can be seen. At this point recorded is the force needed for crimp straightening ( $F_c$ ) and also corresponding elongation ( $\epsilon$ ). The force  $F_c$  is determined on the basis of the force-elongation graph at the point of local minimum of the first derivative of the function (Figure 2), i.e. at the point where the second derivative of the function (Figure 2) is equal zero. Figure 3 shows the changes of the force and elongation at the crimping and elongation limits depending on the first heater temperature and texturing speed.

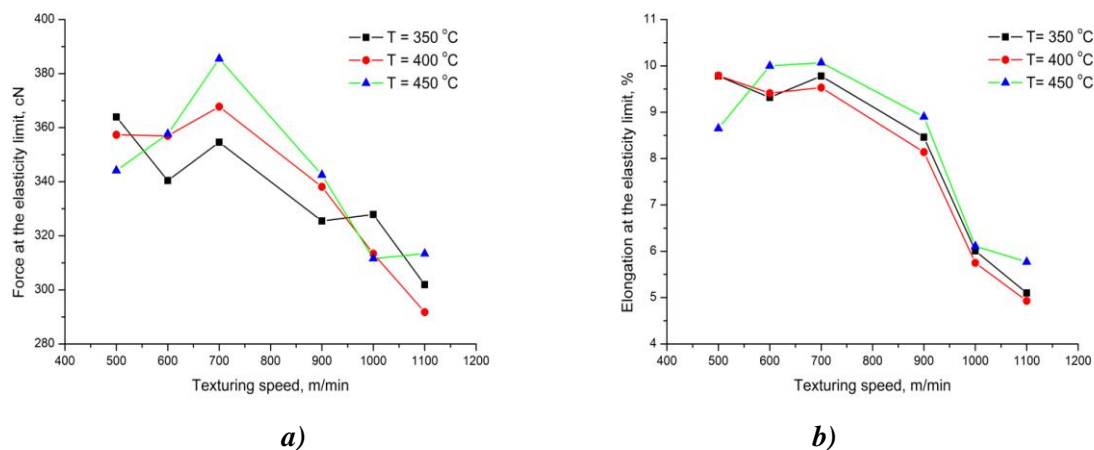

**Figure 3.** The force (a) and elongation (b) at the crimping limit of textured PES filament yarn

The results obtained show the decline of yarn elongation with increase of texturing speed. It can be concluded that higher texturing speed negatively affects the crimping properties of textured PES yarn. At speeds over 900 m/min a considerable reduction of yarn crimping is observed. Results for force intensity at the crimping limit confirm that yarns textured at higher speeds show higher resistance to overcome crimps indicating that at higher texturing speeds yarns with less voluminosity are produced. At the same time, elongation results show that yarns textured at higher temperature have higher crimping compared to yarns textured at lower temperature. Namely, increasing yarn temperature weakens intermolecular interactions resulting in increased mobility and flexibility of macromolecular chains and structural elements enabling easier formation of ordered structures - crystallinities. Individual results deviations from expected results can be the effect of yarn being damaged at lower speeds and higher texturing temperatures. Moreover, POY polyester filament yarn in the process of texturing by false spinning is exposed to the action of both external stretching and twisting forces and internal straining, i.e. contraction due to relaxation processes and increased molecules mobility due to increased temperature. The ability of yarn to resist these force actions depends on the changes in yarn temperature determined by texturing speed and heater temperature. The influence of these two parameters on the straining in yarn is opposed, i.e. by increasing the texturing temperature the breaking of intermolecular interactions is easier and material softens resulting in lowering yarn straining, while by increasing texturing speed the external forces acting on yarn and internal straining in yarn increase. The detected results deviations from the expected can also be the result of the fact that textured multifilament yarns consist of a large number of individual filament threads entering the heater as a thick and compact beam. In that way the migration of individual threads in the twisted filament beam is prevented, in the texturing zone. This leads to uneven temperature distribution (temperature gradient) over the filament yarn cross section (filament threads on the outside surface of the beam will receive more heat than the threads inside the beam) and to asymmetric stretching so that twisting forces distribution is therefore reflected on the crimping of individual threads in multifilament.

After the crimping limit zone comes the zone where monofilaments are mostly oriented along stretching force direction and they are parallel resulting in uniform resistance to stretching forces up to the elasticity limit after which permanent deformations of individual monofilaments occur. The elasticity limit defines permitted yarn load in the subsequent technological processing under which the yarn would not be significantly deformed. By applying stretching force which exceeds elasticity limit plastic deformations occur reflecting negatively on the quality of finished textile products.

The elasticity limit is defined by local maximum of the first derivative of force-elongation function (Figure 2), i.e. at the point where the second derivative of the function (Figure 2) is equal zero. At the point defining elasticity limit the values of force ( $F_e$ ) and elongation ( $\epsilon_e$ ) of analyzed textured PES yarn samples were determined. The parameters are shown in Figure 4.



**Figure 4.** Force (a) and elongation (b) at the elasticity limit of textured PES filament yarns

By analyzing the graphs it can be seen that texturing speeds over 900 m/min negatively affect the force intensity at the elasticity limit. At high texturing speeds, yarn retention time in the heater is shorter; the yarn is less and unevenly heated from outside surface towards the core and therefore in the process of stretching the orientation of molecular chains in filaments is more uneven. On the other hand, lower texturing speeds and higher temperatures damage the yarn also having a negative effect on the quality of textured yarns. Based on the graphs in Figure 4 (a) it can be concluded that force intensities at elasticity limit at texturing speeds 700 m/min and 900 m/min are as expected. At these speeds the force at elasticity limit is increased with the increase of temperature of filament yarn in texturing process.

Interesting results offer the values of force work to the crimping limit and to the elasticity limit. Figure 5 shows the influence of texturing speed and temperature of the first heater on the force work to the crimping limit and force work to the elasticity limit.

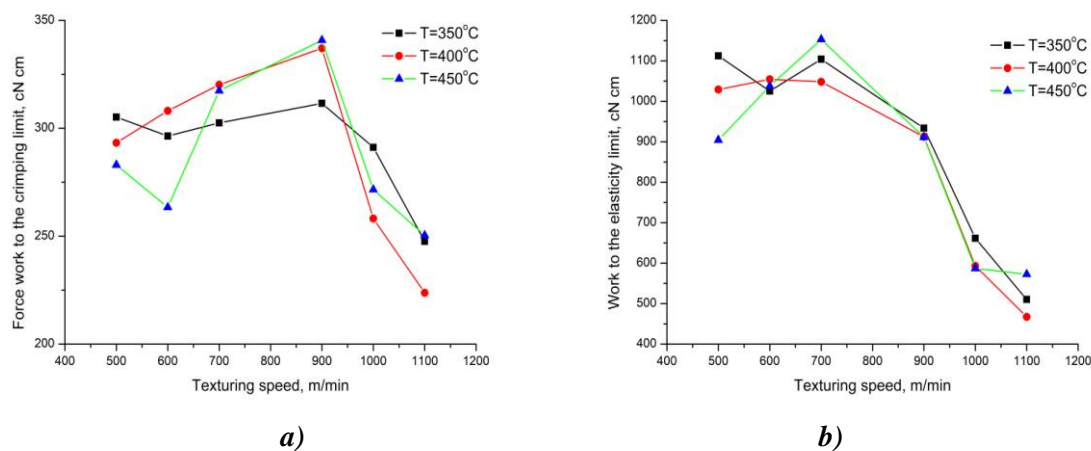

**Figure 5.** The force work to the crimping limit (a) and to the elasticity limit (b) of textured PES filament yarns

The results show that at texturing speeds higher than 900 m/min, force work values to the crimping limit and force work values to the elasticity limit decline. At higher texturing speeds time for relaxation of internal straining is shorter reflecting negatively on the quality of finished produced yarns. Retention time and temperature during yarn heating have an influence on the mutual position of molecular chains striving to the equilibrium state in filament which is in direct relation with the natural tendency of all physical systems to have the minimum potential energy.

## CONCLUSIONS

The most significant parameters in texturing process are texturing speed and heater temperature. The texturing process provides higher flexibility and stretchability than with smooth filaments and, also, better covering power is achieved due to higher voluminosity of textured yarns.

Analyzing the flow of force-elongation function significant data can be obtained showing the properties of textured yarns, and the effect of individual process parameters on the properties. Analyzing parameters of textured yarn in the zone of elastic deformations it is possible to obtain information on voluminosity and elasticity of these yarns which represent a special interest for further yarn processing to final textile materials.

Since the zone of elastic deformation is an insufficiently explored area of textured PES yarn, the investigation had the primary goal to propose methods of characteristics analysis of textured PES filament yarns by interpretation of force-elongation function flow.

This relatively simple method of analysis of textured yarn characteristics can be a starting point for development of new methods for prediction of characteristics of textured filament yarns according to the future purpose. In the concrete case the results have shown that the limit texturing speed for these yarns, in terms of maintaining higher crimping and elasticity is 900 m/min. Also, significant influence on textured yarn quality parameters have texturing process parameters such as temperature of yarn heating, stretching, false spinning, stabilization, winding the yarn on the spools etc. Of course, it should be noted that the quality of textured yarn depends on the type and quality of input POY filament, its production and quality of POY winding as on its ability for unwinding.

## REFERENCES:

- [1] Hearle J W S, Hollick L, Wilson D K. Yarn texturing technology. Woodhead Publishing Limited. Cambridge 2001.
- [2] Atkinson C, False twist textured yarns. Principles, processing and applications. Woodhead Publishing Limited. Cambridge 2012.
- [3] Trajkovic D, Savic M, Kostic M, Majstorovic D, Stojanovic P, Stepanovic J. Dependence of Structural Characteristics of Polyamide Textured Yarns on the Parameters of the False Twist Yarn Texturing Process. *FIBRES & TEXTILES in Eastern Europe* 2017; 25(3): 79-85.
- [4] Eskin N. Analysis of a high temperature heater in a false twist texturing process. *Energy Conversion and Management* 2003; 44(16): 2531–2547.
- [5] Dupeuble J. C. Texturing performance of polyamide yarn on high temperature heaters. *Chemiefasern Textilindustrie* 1993; 43(11): E145-E152.
- [6] Celik P, Ozdil N. Supure G, Experimental investigation on the static and dynamic strength of false twist textured polyester yarns. *Industria Textila* 2011; 62(1): 38-43.
- [7] Shaikh TN. Bhattacharya SS, Deriving an empirical formula to determine the optimum level of false-twist in mechanically-crimped textured polyester yarn. *Textile Research Journal* 2011; 81: 1995-2005.
- [8] Mahish S.S. Punj S.K. Kothari V.K, Comfort and Handle Related Properties of P/V Blended Air-jet Textured Yarn Fabrics. *Fibers and Polymers* 2010; 11(6): 932-940.
- [9] Yildirim K. Altun S. Ulcay Y, Relationship between yarn properties and process parameters in false-twist textured yarn. *J. Engineered Fibers and Fabrics* 2009; 4(2): 26-32.
- [10] Tehran MA. Azimi B. Mojtahedi MRM, Investigating the effect of false twist texturing process on the color coordinates variation of spun-dyed polyester filament yarns. *J. Engineered Fibers and Fabrics* 2011; 6(4): 54-62.
- [11] Karakaşa C. Dayıoğlu H, Influence of false-twist texturing parameters on the structural properties of polyester yarn. *Indian Journal of Fibre & Textile Research* 2005; 30(1): 37-41.
- [12] DIN 53840-1, Determination of parameters for the crimp of textured filament yarns; filament yarns with a linear density exceeding 500 dtex. 1983.
- [13] Stojanovic P. Savic M. Trajkovic D. Stepanovic J. Stamenkovic M. Kostic M, The effect of false-twist texturing parameters on the structure and crimp properties of polyester yarn. *Chemical Industry & Chemical Engineering Quarterly* 2017; 23(3): 411-419.
- [14] Savic M. Trajkovic D. Stepanovic J. Stojanovic P. Kostic M. Majstorovic D, Influence of heater temperature and texturing speed on the physical-mechanical properties of polyamide textured yarns in false-twist texturing process. *Industria textila* 2017; 68(6): 451-457.

## AUTHORSHIP AS A SUBJECT OF COPYRIGHT

Nadežda Ljubojev, Mila Kavalić\*, Sanja Stanisavljev

University of Novi Sad, Technical faculty "Mihajlo Pupin", 23000 Zrenjanin, Đure Đakovića  
bb, Republic of Serbia  
milazakin@gmail.com

### ABSTRACT

*In recognition of copyright protection, an essential requirement is the existence of authorial originality. The question of the originality is part of factual matter and in each concrete case, it is appreciated: whether one work is artfully original or represents an imitation, copy or another kind of imitation of other works. As for the artistic originality of the work, it is presumed that it exists until the limits of permissibility in imitating someone else's work are exceeded, that is, the copyright of other authors are not infringed. Today, in the copyright law, a definition is adopted according to which the author's work implies the original human creation, which has the spiritual content and the particular form in which it is expressed. It follows from the definition that a certain spiritual creation will be considered a work of authorship and enjoy legal protection if it fulfills the conditions described in the paper. The analysis used a historical legal and normative legal method. Also, the authors analyze the properties that are not important for the protection of the author's work.*

**Key words:** *authorship, copyright, and fine and applied arts.*

### INTRODUCTION

Defining an author's work is not an easy task, although it seems easy, so the majority of people think that they know what an authorship is. Such a conclusion stems from the fact that copyright laws, both national and international, generally do not provide a clear definition of the authorship, but the notion of the authorship is determined descriptively, in the sense that the definition refers either to the field of spiritual creativity or to the elements that make up the authorial work. Nevertheless, it can be said that in copyright today, a definition is adopted, according to which the authorship implies the original spiritual creation of a natural person, expressed in a certain form, regardless of their artistic, scientific or other value, their purpose, size, content, and manner of expression, as well as the permissibility of public disclosure of its contents.

Modern copyright laws apply the method of the general clause to determine the definition of the authorship by enumerating certain types of authorial works. The acquisition has the character of the case, that is, it does not exclude legal protection even for those works that are not listed, listed in the law, provided that they fulfill the general clause, that is, they can be considered copyright works.

Law on Copyright and Related Rights "Official Gazette RS ", no. 104/2009, 99/2011 and 119/2012 (further in the text "ZASP") accepts this method of legal regulation and states, for example, authorial works whose purpose is to provide a basic example of what is copyright and what enjoys copyright protection.

The copyright works are considered:

- *written works* (books, brochures, articles, translations, computer programs, etc.);
- *spoken works* (lectures, speeches, words, etc.);
- *drama, drama-musical, choreographic and pantomime works, as well as folklore works;*
- *musical works* with or without words;
- *film works* (cinematographic and television works);
- *works of art* (paintings, drawings, sketches, graphics, sculptures, etc.);
- *works of architecture, applied art, and industrial design;*
- *cartographic works* (geographical and topographic maps);
- plans, sketches, models, photos ;
- theatrical plays.

Works of fine arts enjoy copyright protection and are considered copyrighted works under the same conditions as other works of art. In protected works of fine arts, in the narrow sense, they include works of painting, sculpture, graphics, carving, copper cuts, etc. Works of fine art include architectural works. Also, the author's works include works of applied art and industrial design (Milic, 2009). »[Applied art](#) is the designing and decorating of functional objects or materials to give them aesthetic appeal, e.g. printing type, ceramics, glass, furniture, metal work and textiles.« The term is frequently used to differentiate this type of work from the fine arts (painting, drawing, sculpture) whose value is primarily aesthetic.« (Encyclopedia of Art, <http://www.visual-arts-cork.com/art-glossary-of-terms.htm>). The works of applied art include ship models (Judgment of the District Court in Belgrade P 1358/74 and the Supreme Court of Serbia in Belgrade Gz 437/80).

Works that are not explicitly foreseen by ZASP, if they meet the requirements of the general clause, enjoy the same legal protection as the copyrighted works included in the listing.

In theory, it is emphasized that the advantage of this method of determining the so-called "general clauses" or the general notion of author's work in that it does not narrow down the space in which one work can be created and enjoy legal protection. In order for work to be suitable for copyright protection, it is only necessary to be the original spiritual creation expressed in a certain form.

Accordingly, it is customary to state the division into literary, music, visual, film and other works in the law. Our subject of interest are the works of applied art as a kind of authorial work, so the accent will be placed on their copyright protection.

## AUTHORIAL WORK PROTECTION

The subject of copyright protection is a copyrighted work. Subjective copyright is created by the very act of creating an authorial work (Bainbridge, 2007).

Today, in copyright, a definition is adopted, according to which the author's work implies the *original human creation, which has the spiritual content and the particular form it is expressed in* (Markovic, Popovic, 2013, 38) (Besarovic, 2005; Miladinovic, 2009).

From the definition, it follows that a certain spiritual creation would be considered a work of authorship and in order to enjoy legal protection should fulfill the following conditions:

- a) to be *original*,
- b) that it is *spiritual content*,
- c) that it is a *human creation* (the creation of a physical person ),
- d) that it is expressed in a certain *form*.

## Originality

The authorial work must be original, which is an essential feature of this work. The originality of the authorial work is its individuality, that is, the *uniqueness* of the work, as the basic characteristic of the notion of the author's work, for which the law recognizes copyright protection for a specific work. The authorial work is protected only if it is original, that is, it is the only valuable element of the definition of the authorial work (Besarovic, 2011, 243). Otherwise, the originality of the work represents a generally accepted condition for the granting of copyright protection in comparative law.

In the copyright scientific theory, there is an understanding that "by originality, two types of originality can be understood: one related to the personality of the author - authorial originality; and the one related to the result of the author's work - the originality of the work" (Besarovic, 2011, 247).

The originality of the authorial work is in the personality of the author of the work.

Therefore, the work is individualized by the author, and the author, in turn, imprints the seal of personal, special and original into the work he has created. It is originally, therefore, the work that his creator created in his own specific way by breathing his individual spiritual seal into that creation, not by supporting the works of other authors. In this way, their creation receives the necessary condition which is expressed through the quality of the original work. However, this does not mean that the author's works must not rely on other works, especially since in copyright this is in most cases inevitable. The essence is that a new authorial work that was created on the basis of inspiration in the second part must contain a certain degree of originality as a reflection of the personality of the author of the new work (Ljubojev & Varga, 2014). "Sometimes shades are enough for the authorial work to imprint originality, so that in the reader or viewer they cause a feeling of unusual or until then an unseen work." (Damjanovic & Maric, 2007, 47).

The originality of the author's work must be judged in an objective way (Goldstein, 2010). The basic prerequisite for the existence of the originality of a work depends on the type of work, or the area it belongs to because there are areas of human creativity that are predetermined by technical, functional or other conditions so that they do not leave the possibility of expressing individual personality traits. For example, this would be the case with making a list of residents of a city, solving a mathematical task, and so on. In this case, it is obvious that if, for example, more people accepted that one or the other of them would do one or the other, everyone would get the same or significantly similar result, which means that none of them would be able to express their individual line and marks his work as original. On the other hand, there are certain areas of human creativity in which the space for expressing individuality is greater, but it is still limited by technical, logical, functional or other conditionality. This is, for example, a case with certain creatures, such as patterns, catalogs, advertising slogans, and the like. These creations are treated in the author's theoretical theory as the creations of an "ephemeral", "consuming" character and, if they are not identical to an existing one, they are considered original and enjoy copyright protection) (Markovic & Popovic, 2013, 41; Miladinovic, 2009, 184).

Therefore, it is not easy to determine whether a work is original. For this reason, the fulfillment of this condition should be assessed in a flexible manner, and bearing in mind that, from the point of view of copyright, every spiritual creation that is not the result of "deliberate or unconscious reflection of the already existing cultural heritage is original, or is not the result of work strictly determined by external frames which do not leave space for expressing the personal spiritual individuality of the one who creates it." (Markovic, 1999, 124).

## Spiritual Content

Authorial work is a spiritual creation with spiritual content, which gives the authorial work a meaning, through which communication with other people is being established.



Thanks to this feature, the authorial work is socially viewed as a social creation whose function is to mediate communication between people. The communication that a creative work establishes between people as its users must be direct, that is, based on the meaning of work. Creations like, for example, a multi-way ticket, a credit card, and so on, do not have the status of the authorial work, because they do not have spiritual content by themselves, that is, they are not the means of direct communication between people. These creations acquire meaning only through rules for their use or interpretation, which are beyond the very creation (Miladinovic, 2011, 185).

### **Human Creation**

A work is a human creation only if it is made by the work of a man. This means, in fact, that something that previously existed in nature was not considered authorial work, and the man found it and presented it as work (shapes of wood, stone or some other objects shaped by natural forces to resemble works of fine arts - special stone form or rocks in Djavolja Varos).

Also, there are certain creatures that originate from animals (the song of nightingale) and are not creations in terms of copyright.

However, in certain cases, there are works created by the activity of the device. For example, today's designing is done on a computer; however, man's role is key one because computer technology, no matter how much it has been perfected, cannot function itself until a man sets it on. Accordingly, a person can use devices as an auxiliary means for their creation. The created works are creations, which from the author's legal point of view means that, in the case of the application of technical aids in the creation of authorial work the individual character of a man comes to the point.

### **Specificity of the Form**

Authorship is a complex process consisting of several stages. As a rule, this process starts with an idea, which during the creative process gradually acquires a more concrete form, so it is finally expressed in a certain form, "which enables the author to manifest that spiritual content or tells it to other people." (Spaic, 1983, 120). The shaping of spiritual content in a certain form gives the identity to authorial work. Thanks to the form, the authorial work is being separated from the personality of the author and the communication becomes available to the public, as well as for commercial use (Terence, 2000). From this, it follows that non-shaped and unspecified spiritual content is not considered copyright work because it does not meet the condition of specificity of the form.

In theory, it is pointed out that when it comes to determining the form, from the point of view of copyright, "it does not concern the material form in which the work becomes virtually accessible to the senses of people." (Markovic & Popovic, 2013, 39). For example, a literary work can be communicated to the public in the form of a book, or it can be recorded on a CD, or it can be communicated to the public and through oral presentation. Consequently, it does not matter whether the work is communicated to the public nor it is essential in which material means it was done (Ploman et al., 1980). But the author's work as a spiritual content expressed in a certain form is immaterial.

From the author's legal point of view, the form of the authorial work is defined as "a specific arrangement of characters that people use in their communication, which is different depending on the type of copyright work." (Miladinovic, 2011, 186). Literary works are expressed in the form of a sequence of certain words and sentences, musical works are expressed in the form of sequences of tones, works of painting are expressed in the form of geometric images, colors, etc.

Copyright protection is enjoyed by a computer program expressed in any form (Drakulic, 2009). Under the form of a computer program, it is understood that: the source code (when expressed in one of the programming languages), the object code (in the form of binary numbers, i.e. in the machine

language) and the executable code (electronic digital record on the body carrier: magnetic tape, CD) (*Standard Glossary of Software Engineering Terminology, Inc.*, 1983.)

In the authorial scientific theory, there is an understanding that an expressive form does not have to be a definite form. It is considered that it is not necessary for the work to be fully completed in order to enjoy legal protection. Uncompleted works enjoy the legal protection provided that the expressive form meets the requirement of originality. It reads as follows: "Whether an uncompleted work will enjoy legal protection depends on the" degree "of the expressive form in which the content of the work is expressed." (Besarovic, 2005, 246)

### **Properties that are not Important for the Protection of Copyright Work**

Starting from the notion of the authorial work, it follows that in the copyright for authorial work it is not important whether its quality, whether it has some practical purpose, and what its purpose is, then whether and how it can be used economically, and whether its disclosure and public disclosure is contrary to the law.

The quality of one part, measured by cultural criteria (art, trash, etc.), is a relative matter and from the point of view of copyright is of no significance. Concrete judgments on the quality of one part are provided by end users of copyright works - consumers in the classical sense of the word, i.e. consumers, readers, viewers, etc. (Markovic, Popovic, 2013, 39). "Artistic value is a subjective category that depends on a number of factors: degree of education, age, personal affinity, environment, fashion trends, etc. It would be very difficult for the legislator to incorporate some criteria in order to assess the artistic value of the author's work on the basis of which the protection would be granted." (Besarovic, 2011, 263)

In order for a computer program to enjoy legal protection as a copyrighted work, it is necessary that the result of original human creativity is expressed in some form suitable for such work (Ljubojev, 2011, 309-315). No other criteria apply to determine whether any work falls under this protection, because it is considered that the criteria applied to determine whether a computer program represents or does not represent the original work should not contain any quality assessment or aesthetic of the value of the program (Directive 91/250, Articles 1 (2) and (3)).

For authorship purposes, copyright is also irrelevant, because a creation that fulfills the statutory requirements will enjoy copyright protection regardless of whose it is intended to be in a subjective sense.

From the author's legal point of view the scope of work is not of significance either (Lewinski, 2008). This means in concrete terms that the same protection, and the same rights, are enjoyed by the author of the collected literary works, and the author of one volume of the pocket edition or the author of aphorisms, of only a few words or sentences.

Copyright protection also enjoys work regardless of whether its publication and publicity are contrary to law and morality (pornography, recourse to national, religious and other intolerance, etc.). For example, if a person makes a work of such content that he or she is committing a criminal offense or a misdemeanor act, that person will be criminally persecuted for his / her conduct. However, any person who multiplied this work, communicated it to the public as their own, put it into circulation, or used it in any way, would constitute a violation of the rights of the author of that work.

Also from the author's legal point of view and protection, there is no importance in the amount of time, the amount of money and the effort spent in creating the authorial work.

## CONCLUSIONS

In order for one piece to enjoy legal protection as an authorial work, it is necessary to fulfill the conditions envisaged by the positive regulations of the country where the legal protection is sought. National copyright laws determine the notion of authorial work and the conditions that one must fulfill in order to enjoy copyright protection.

Subjective copyright is created by the very act of creating the authorial work. Accordingly, the acquisition of subjective copyright does not require the fulfillment of any formalities in terms of undertaking a particular procedure in which the administrative or judicial authorities would determine the fulfillment of formal and material conditions for the recognition of a subjective right to the author of the work or his legal successor.

Authorial work is a human creation that has spiritual content, which has a certain form and which is genuine. A work is a human creation only if it is made by the work of a man.

However, in certain cases, there are works created by the activity of the device. For example, today's designing is done on a computer; however, man's role is key one because computer technology, no matter how much it has been perfected, cannot function itself until a man sets it on. Accordingly, a person can use devices as an auxiliary means for their creation.

The created works are creations, which from the author's legal point of view means that, in the case of the application of technical aids in the creation of authorial work the individual character of a man comes to the point.

In addition to the fact that the authorial work is a human creation, it must be *genuine*, which is an essential feature of this work. The originality of the authorial work is its *individuality*, that is, the *uniqueness* of the work, as the basic characteristic of the notion of the author's work, for which the law recognizes copyright protection for a specific work. Authorial work is a spiritual creation with spiritual content, which gives the authorial work a meaning, through which communication with other people is being established. But the author's work as a spiritual content expressed in a certain form is *immaterial*.

## REFERENCES

- [1] Bainbridge, D. (2007). Intellectual Property, Harlow.
- [2] Besarovic, V. (2011). Intelektualna svojina, Beograd.
- [3] Council Directive 91/250/EEC of 14 May 1991 on the legal protection of computer programs (Official Journal L 122, 17/05/1991).
- [4] Damnjanovic, K., Maric, V. (2007). Intelektualna svojina, Beograd.
- [5] Drakulić, M., (2009). Osnovi kompjuterskog prava, Beograd, 361-362.
- [6] Goldstein, P., Hugenholtz, B., (2010). International Copyright, Oxford University Press.
- [7] Lewinski S, (2008). International Copyright Law and Policy, Oxford University Press.
- [8] Ljubojev, N., Varga, S., (2014). Zaštita kompjuterskog program sa osnovama Autorskog i Patentnog prava, Univerzitet u Novom Sadu, Tehnički fakultet „Mihajlo Pupin“, Zrenjanin.
- [9] Ljubojev, N, (2011). Legal Protection for Software in European Union and Serbian Law, Proceedings, International conference – Process Technology and Environmental Protection, University of Novi Sad, Technical Faculty “Mihajlo Pupin” I (1).
- [10] Markovic, S., (1999). Autorsko pravo i srodna prava, Beograd.
- [11] Markovic, S., Popovic, D., (2013). Pravo intelektualne svojine, Pravni fakultet Univerziteta u Beogradu, Beograd.
- [12] Miladinovic, Z., (2011). Pravo intelektualne svojine, Kragujevac.
- [13] Milic, D., (2009) Komentar Zakona o autorskim i srodnim pravima, sa sudskom praksom i međunarodnim konvencijama i ugovorima, Beograd, 196.

- [14] Ploman W., Hamilton E., Clark, L., 1980 Copyright: Intellectual Property in the Information Age, London.
- [15] Spaic, V, (1983). Teorija autorskog prava i autorsko pravo u SFRJ, Zagreb, Beograd, Čakovec.
- [16] Standard Glossary of Software Engineering Terminology, Inc. New York, 1983.
- [17] Terence P., (2000). European Intellectual Property Law, Ashgate, New York,.
- [18] Zakon o autorskim i srodnim pravima („Sl. glasnik RS”, br. 104/2009, 99/2011 i 119/2012).

## SCARVES AS AN ELEMENT OF CLOTHING IN THE TWENTIETH CENTURY

**Stanislava Sindelić, Srđan Cakić, Vasilije Petrović, Danka Joksimović, Anita Milivojević**  
Technical faculty „Mihajlo Pupin“, Zrenjanin, Serbia  
e-mail: [s.stasa@yahoo.com](mailto:s.stasa@yahoo.com)

### ABSTRACT

*Scarf is one of the rare elements of fashion history that reaches far into the beginnings of dressing and as such is an important document of one historical chapter. Through all this journey, she changed the shape, texture, composition, colors and still has remained until today as a unique companion of style. Today in the 21st century it is a symbol of status, a sophisticated element of elegance and a sign of affiliation that meets social aesthetic criteria. It takes great significance in the sociological, religious, ethnological, historical and psychological aspects of feminine and feminine dressing around the world. It is today a stylistic supplement, a textile product that primarily reveals and emphasizes the attitude of the person who carries it.*

**Key words:** scarf, scarves, veil, fashion history

### INTRODUCTION

Scarf has the power to supplement and reinforce the aesthetic component of the suit as an accompanying detail, but also to realize the functionality necessary in modern dressing. Its distinctiveness and what separates it from other hats is precisely the multipurpose application and transformation from one form to another. The original role was primarily protective, to keep the head and face from adverse weather conditions, such as wind, rain and strong sun. In a religious aspect and a conservative view of the role of a woman in the community, she has the role of concealing and sheltering a woman's face. Her role is to "protect" her and cover her from undesirable views. In the aesthetic sense, scarves have the power to emphasize creativity and make up their clothes with their ornaments, prints, colors or a selection of materials. In addition to wearing it on the head, they descended to the neck, then to the chest, as a binder for various wears, like a robe, around a belt skirts, skirts, etc. It is today much more than a textile detail. The way we tie it, we wear, the choice of color, size, ornamentation, shape, style is precisely what gives us the opportunity to express our peculiarity, character or conservatism in clothing. With a scarf, it's easy to get a bit of formalities and elegance in a casual look.

The changing geometry and the power to establish the balance of the overall appearance as a fashion additive is exactly what led me to a more detailed survey of the scarf. If we look at the wool as a subject in its wider sense, as a piece of canvas dressing that has a dual purpose for a functional or aesthetic, then its roots reach deep into the history of the costumes. However, if the research subject is treated as a piece of printed textile of a square shape then its beginnings will exist at the end of the sixth century. In the analysis of this work, she was treated in a broader sense, because it was precisely in her multifunctionality and variability that it was the essence of survival through all fashion changes.

The paper analyzes its journey through the historical epochs of the earliest recordings in the ancient period, where it originally belongs to the contemporary fall of the XXI century. The sociological aspect of wearing the scarf is very important and it is analyzed through the religious code of dress and the need for women to be associated with religious affiliation. One of the most inspiring sources of collection design analysis was the research paper about ethnographic elements of scarves in Backa, Vojvodina. Through the primaries of world fashion houses like Hermes, Gucci, Givenchy,

I have tried to illustrate the wealth of designs in XX and XXI, and the scarf that becomes a "painting canvas" in a wearing sense.

Suitable for sampling, embroidery, printing, and various applications, it is a never-ending source for many designers around the world. It's gratifying shape, which can be square, rectangular, triangular or some other is because of this simplicity, is universal whether it is placed on the neck, head, on the belt, on the bag, like a cloak. It easily adapts to the frenzy of trends, and for this reason many fashion houses have as regular accessories. Its popularity has oscillated during the history of the outbreak, from margin to main role. Various hats and headgear features like coronets, hats, and tapes, may have been more common in everyday life, but what shawl gives an advantage over them is softness, subtlety and transformation.

Although we are aware of the dramatic social changes that have reflected on the notion of contemporary deviance, wearing a scarf can send a clear non-verbal message to the observer. It was considered by the symbol of modesty, which was specifically spelled out through various religious codes. Identification of the headgear is particularly marked in classes and occupations. The basic laws were banned from lower classes to wear the same head covering that was worn by the aristocracy. Scarves can be a good communicator of the world where the media play an unmistakable role, as well as the dizzying trends and messages. It was often used as a propaganda material for the launch of airline companies, various social movements, companies, banks, religious, and as a part of uniform in the era of socialism. This is a powerful weapon in the world of adverts, because its simplicity is its advantage.

## **20TH CENTURY**

During the first decades of the twentieth century, Scarf continued its journey through fashion styles. The female part becomes more natural, more relaxed, more comfortably united. Despite the upcoming climate of change, women in the first years of the twentieth century, have been reluctant to leave the corset. The period *Belle Époque*, with which we begin the historical research of the scarves, and all possible variations of this fashion detail, retained the so-called "healthy corset" until 1910. Along with the "S" silhouette, the lace, the tie and the muslin layers, the bows are spontaneously tied to the hat, worn over the shoulder and around the neck. Wide lining of the hat had been complemented by rich wrinkles of draped soot and plush. Satin skins would be attached to straw hats, which were a favorite decoration among women. Bows were often wired, so they would not "fall" when wearing them.

The veil was a favorite detail that could be worn on all occasions. In time of sadness it was always in dark colors. With the bridal dress, it was an ornament and the young bride would gladly put it on her hair. Venice lace veils were famous. In daily walks and gatherings, ladies would have pointed at the hats. We distinguish several styles, as the harem style, which is like a hijab from the Far East, and the one most common where the veil is only hooked to the rim of the hat. Besides muslin, tulle or net, often it would have "chiffon" or some similar material on the edge of the veil. In the twentieth century women are more and more engaged in sports, and in many disciplines competing with men. The first cars that were open, such as a convertible, were designed for men and women. They were practical, with the aim of protecting the driver from the glass, rains, sunshine, various gases, etc. Few drivers would usually wear gray veils, which would be put on a modern hat over the course of the day.<sup>1</sup> Protective glasses would be worn during the ride.

Since 1910, there has been a one-way release of a solid form of women's jacket and long suits. The corsets went into complete oblivion. The women became more independent, the first fashion names appeared, so more and more designers began participating in the fashion game.

The French poet Paul Poiret<sup>2</sup> subtly introduces orator elements into a women's wardrobe like a wide sleeve, a kimono dress, a harem pants and long tunics. With the new style of lifestyle that launches the Poiret scarf, it has been transformed into a turban that is indispensable with a newly styled oriental style. The favorite thread created under the new influence is the tightening of the beam of air, pear, and white eagles and so on.



*Figure 1. 1910-1920.*

During the First World War of 1914-1918, the whole world was affected, and the decline changed considerably. There were significant social changes, women took up men's jobs and changed them to workplaces where they had not been before. Women, pantyhose and poverty replaced women's trousers, lace and silk shifted cotton and wool, the luxuries were silent. It was considered irrelevant not to solidify with the suffering of the peoples. Scarf has this time been given the main role in protecting the hair. Everyone, nurses wear a scarf like a lace, a woman in the field, wearing a kind of turban in the factories. In the picture, there are nurses of Red Cross in Second World War.



*Figure 2. First World War*

After the war years, during the second decade, women's skirt becomes narrower, shorter, fashion adapts to a new lifestyle.

Women have the need to exercise to remain slim and they want clothes that they can easily move and play. The evening neckline for evening outings is longer and longer, the silhouette is elongated with a low-wasted waist. Small square cotton gowns worn around the neck contributed to the alleviation of this contrast in order to preserve the modesty of the lady.<sup>3</sup> The younger women are more likely to prefer bandwidths, scarves, bandages and even luxurious combs, night and evening women's toilets. Bandana is a way to bind a scarf on your head, popular around the world. The following text will be described in detail.

In the twenties of the twentieth century, the scarf is long, rectangular, worn like a band around the head, as a detail about the belt that freely falls on the hips. In Figure 25, shoe wear was shown in several ways. In the image she is like a long eyelash tied loosely around the neck, while on the right we have a classic combination of black and gold with a scarf tied to the head in a bandana.<sup>4</sup>

Its popularity has been contributed by the film and music industry, the jewels are heard, the players, the dancers, the Latin players and other artists have respected. It is a story about the passionate Isadora Duncan<sup>5</sup> who, after leaving for Russia, finds love of his life. Yesenin began a great love story that quickly turned into drama and tragedy. Their relationship was remembered as one of the greatest and most tragic love of all time. On December 28, 1925, in the Hotel "Aglitter" in Leningrad Yesenin committed suicide in three ways, to be sure of his death. He had ruled for himself in the room he once had with Isadora. He cut off the veins, set fire to the heating pipe and wrapped the scarf that he had once given to loved Isadora around his neck and hanged himself. How fate tragically played with these two lovers is also the moment of the accident that hit the passionate Isadora. In Nis with then young lover, on the 14th of September, 1927, she switched her red scarf around her neck and started to walk. The scarf, which was its trademark, wrapped it around the wheel of the car on the move and drowned her.<sup>6</sup>



Figure 3. Picture left in 1925



Figure 4. 1929.

The madness of the twenties is squeezed by the arrival of the elegant thirties. One of the textile newspapers is the emergence of new synthetic fibers such as the reyon. It was one of the first artificial materials, which was used as a cheap alternative to silk. The charms were made from cheaper fabrics, which were tied as triangle, on the neck, which is still one of the most common ways to wear a scarf. The competing motifs were various tufts and simple geometric solutions. Hermes<sup>7</sup> launches, nowadays famous 36 inches square, silk scarves with a horse print 1937. They are also on the occasion of the centenary of the opening of the first store. These scarves will become a status symbol among many conservative fashion followers, including Queen Elizabeth II.<sup>8</sup>

In the evening toilets, women looked like Greek caryatids, with long and wide silk scarves that shuffled around of their back.

In the airy muslin scarves, tassels or feathers were rubbed on the edges, which was a luxurious detail alongside the night-time feathers.

The forties had the effect of depression and war likeness that had a significant effect on all social spheres. It was considered a rude and distasteful occurrence in clothes made of expensive and fine materials. The Second World War left its consequences to the whole world. The garments become narrower and shorter, saving on the material, and for these reasons, the stems became less dense, more modest and purified from luxurious accessories. Sweaters were replaced with cotton and synthetic fibers. National colors were painted, and they were often decorated with prints with political features and patriotic messages. In France, the marbles with the image of the marshal petunia and others are symbolic of the new France brand. They are fashioned in French newspapers such as L'officiel de la mode de Paris in 1941. These are scarf-typed typewriters that carry the message of "the holy land of the earth" and "Sovela France."<sup>9</sup>

Scarves are worn more for practical than for aesthetic reasons, as in the First World War. During the war, scarves were worn on the head and neck, the hair was shortened and there were no more delusions. The turbans were loved both in daytime and in the evening.



They were ideally concealing their hair, the hairstyle was not important, because they were not removed indoors in contrast to the hat. In figure 23, it shows the fashion in America, during the period from 1940-45. Years. It is some kind of dress suit with a white turban, while a doll wears a Canadian cotton jacket, and on the head of the patch cotton print for a bandana turban. Many magazines are like the September issue of Marie Claire's 1943 print-friendly instructions for fitting turbans, as illustrated in the figure on the right.<sup>10</sup>

The film industry developed rapidly and used it as a powerful propaganda tool for the Second World War. In the aftermath of the war, in the period 1945-50 million people went to the cinema during the week, which gives us the knowledge of what a powerful mechanism that is? The actors of this timeline Loren Bekol, Ingrid Bergman, Rite Heights<sup>11</sup> were the main fashion models for many women around the world. Great influence was also played on music, popularity of sports, trends in art and design influences in all areas. Forty pin-up girls and Hollywood actresses they become protective faces of cosmetic houses, their faces are present on various products. Photographs of the same in bold pose, on the beach in the swimsuit become a phenomenon of that time and their impact on women around the world was global. Glamour settled on the beach which brought the scarf into a new dimension. Large square scarves, such as sarongs and oars, became an exceptional companion for bikinis.<sup>12</sup>

The automotive industry takes great care and is very important for creating a personal style and popularizing a wardrobe. A scene from films in which the enthusiastic actresses are driving in convertibles with a silk scarf wrapped around the head and big glasses have become a stereotype. Many fashion houses have pretended creative graphic designs on scarves, as a light symbol of luxury and wealth. If it was impossible to buy Dior's dress, it might have been possible to buy a scarf as a fraction of the luxury. Cosmetic houses were offering them often using their products as an auxiliary ion through propaganda. First American lady, Jacqueline Kenedi<sup>13</sup>, wore a scarf with a purified line dresses and coats, and its impact was very strong on women worldwide.

In the sixties, there are major social changes that have particularly affected the lifestyle of young people. This is the decade of new rhythms in music, the emergence of rock and roll, hip-hop, sexual revolutions, fashion designers, etc. The female figure changes significantly, the body's leaner clothing becomes shorter and narrower. The body is more revealing, wearing "A" silhouette and very short skirts with the appearance of mini-length. Much is experimenting with materials such as PVC and metallic fabrics, shiny nylon, lame. Small square scarves are worn around the neck or as a tape on the head. They come to show interesting designs inspired by the new social order. Pit Mondrian, pop art, op art and others artistic directions make aesthetic influence on the art design of scarves and textiles in general.



Figure 5. In the forties, turbans

The seventies are famous for children's flowers, Hendricks, protests in Vietnam, punk music, rejection of brass, LSD and others. Even floral influence came from the East, reflecting on the hippie mode of that period. The hippies would gladly tie a scarf around the head as "fitchu" style. Maxi fashion was a colorful synthesis, a skirt of skirts, jeans style and long scarves that reached the platform. All this would be framed by a large rustic, knit triangle with a scarf, like a robe. They wear patchwork and braided kaftans and poncho with long skirts, this style is known as "Granny look" or grandma style. Scarves are becoming an interesting social document of history.

Men wore a scarf as a sign of good taste during the twentieth century. What a cheerful occasion, it's a sharper, thicker and more colorful shawl. On the other hand, formal occasions require fine silk scarves that can be set with silk. Kashmir scarves are the best choice between thermal performance and formal appearance.<sup>14</sup> The ghost of bohemian descent, the spirit of social exclusivity, which marked the phenomenon of dandy, was restored in the seventies of the twentieth century, when, after the thrust of the concept of the baby boys and their characters - from the leveling of the polar differences to the ideology of indifference - the silk scarf together with the controlled "tarzanka"<sup>54</sup> became a mandatory supplement for a modern and free man. One of the most prominent promoters of this message is Hugh Hefner<sup>14</sup>, who made his famous silk pajamas perfect with a silk scarf!<sup>15</sup> In addition to floral, zoomorphic and geometric motifs from traditional Indian heritage, there was a creative release when it comes to designing textiles. The designer Karol Osten<sup>57</sup> said, "How far away we can give up, the sophistication of the textile matter, the fluidity of the phantasm." Just a mix of different styles, experiments so far unbeaten came to the fashion scene.



*Figure 6. Triangle scarf*

At the time of the secession, floral motifs were highly emphasized, while in the cube stage prevailed geometrically prints. The painters, futurists, surrealists and other painters had a strong influence on the design of textiles, which also reflected on the design of the scarves. As we got closer to the end of the century, about being smaller, cleaner in aspiration for minimalism. The stamps as a document of that time were often monochrome or with reduced graphics in the form of a company logo.

This is the decade in which luxury was poured out through expensive coats, silk blouses, crocodile skirts, and on the other side of street style, where a stylish chaos dominated. What was full of volume, large, rich, and for that reason was not covered with scarves. At the beginning of the 80s, the turbans were again worn, forming one or more shrubs. "Queen" of pop music Madonna, with its sultry style, has launched a trend that young women copied around the world. In addition to the crossbones, colorful bracelets, twisted, worn-out hair on the head, the hats are tied to the skirt. It only wears on weddings, and is usually colored in color. The wedding of the Princess Diane<sup>16</sup> promotes British fashion in the famous dress of David and Elizabeth Emanuel<sup>17</sup> with a long veil.

At the end of the twentieth century with the emergence of new fashion styles such as gothic, Lolita, new romance, hip-hop, revs, rock, grand, sport and many others, there is a change in approach and perception of fashion. She has experienced countless variations during the nineties, which have been taken to the minimalist concept. For each of the above mentioned fashion trends, scarf has found its application, somewhat less so. I would like to make it an example in the manners of the appearance of Axel Rous was unthinkable without cotton scarves tied around her head. In a romantic edition she is fluttering, pastel with a floral print and hinged or folded around her neck. Designers always try to make a

collection of interesting accessories such as scarves, jewels ... Marbles or large squares, like a long scarf, a thin eyebrow, a troupe with a resemblance on us is to accept it as accompanying new trends by which the savior is always more interesting.

## CONCLUSION

No influential element contributes to maintaining the traditional identity of a particular ethnic community as a scarf. She is the upper, visible lance that is so simple in shape, and yet culturally significant is embedded in some riddles. Like a feather, with its appearance influences and defines our attitude. Maintaining a social tradition, which is aimed at irreversible, we come to a conflict with fashion that tends to change. Through the elements of a traditional dress we also take our minds and let us know that we take care and think about what we wear and what kind of mess we send to our clothes. She is a non-limited accessory. That is the reason for her longevity and eternal survival. It is like a good artwork, a mirror of an individual and time.

## REFERENCES

- [1] S. Pendergast and T. Pendergast, *Fashion, Costume, and Culture: Clothing, Headwear, Body Decorations, and Footwear through the Ages*
- [2] Balkwill, R. *Clothes and Crafts in Ancient Egypt*. Milwaukee, WI: Gareth Stevens, 2000
- [3] Racinet A. *The complete costume history*, Taschen,
- [4] Hartley D. *Mediaeval Costume and Life*. London, England: B. T. Batsford, 1931.
- [5] Васић П. *Одело и оружје*, Универзитет уметности у Београду
- [6] Cosgrave B. *The Complete History of Costume and Fashion: From Ancient Egypt to the Present Day*. New York: Checkmark Books, 2000
- [7] Роегзел Б. *Центлмен, Водич кроз класичну мушкунмоду*, 2009 Tandem Verlag GmbH
- [8] Houston, Mary G. *Ancient Greek, Roman, and Byzantine Costume and Decoration*.
- [9] Fischel A., Baggaley A., O'Hara S., Sturgeon A., Gersh C., Khurana A.; *Fashion the ultimate book of costume and style*.
- [10] Жагар Ј. *Покривала, Љубљана 2004*

## MEASUREMENT OF LOSS OF THERMAL GLAY HEATING PERIOD FROM THE TYPE OF MATERIAL

**Sanja Jovic, Vasilije Petrovic, Danka Joksimovic, Anita Milosavljevic**

\*Technical faculty "Mihajlo Pupin", Zrenjanin

\*Faculty of Technology Leskovac, University of Nis - The scholarship holder of the Ministry

e-mail: [jovic.sanja123@gmail.com](mailto:jovic.sanja123@gmail.com)

### ABSTRACT

*In this study, it was tested which material best preserves thermal clay heat at room temperature (25 °C). The test was conducted for 8 hours, where the results were recorded for each hour.*

### INTRODUCTION

Heat has a pleasant effect on the organism, the spread of blood vessels, improvements in circulation and oxidative processes in the body. It is also beneficial in muscle relaxation and elimination of pain-causing metabolites. Thermal therapies are not recommended for febrile states, infections, heart and lung disease, malignant tumors, and more.

The body loses heat by evaporation (sweating); for this reason, with longer thermotherapy procedures, it is necessary to have a material that is pleasant and has a good absorption capability, it is also important that as little heat is prolonged the duration of the therapy.

### TESTED MATERIALS

- 1) Terry - cotton fabric with bulging but unheated loops that absorbs liquid well.



*Picture 1: Appearance of terry*

- 2) Microfiber - Resistant to wear, easy to maintain and very pleasant for the skin. Between the fibers woven into a piece of textile there are microwaves, that is, places where the outer particles are stored.



*Picture 2: The look of the microfiber*

The test was performed using a digital thermostat XH-W3001 ranging from -50 ° C to 110 ° C. The measuring device consists of an input probe, and the measurement accuracy is  $\pm 0.2$  ° C.



*Picture 3: Digital thermostat XH-W3001*

### **Heat conducting**

The thermal conductivity of the material depends on its chemical composition, structure, temperature. The amount of heat transferred in the unit of time is dependent on the thermal conductivity.

### **Measurement method**

To start the measurement, it was necessary to warm the clay in a microwave, at a power of 600W for 4 minutes. After that, the clay bag is placed in the pillow of the desired material, the thermostat probe is placed so that it is surrounded by a pillow and we do not move to the end of the measurement. It is necessary to record the initial temperatures and repeat it every hour. In the first two hours, the results are recorded every 30 minutes, because the heat is lost at a higher temperature, because of the heat character that passes from the body more to the body of the lower temperature.



*Pictures 4 and 5: Appearance of clay without pillow and method of measurement*

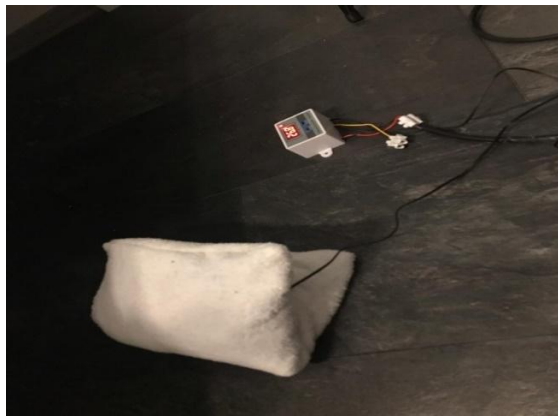

*Pictures 6 and 7: The look of the pillowcase and the method of measurement*



*Pictures 8 and 9: The appearance of a microfiber pillow and a method of measurement*

Time (h)	Without material	Microfiber	Terry
7:00	50°C	50°C	50°C
7:30	48,1°C	47,2°C	47,°C
8:00	45,4°C	44,9°C	44°C
8:30	42,3°C	42,4°C	42,1°C
9:00	38,5°C	39,5°C	39,4°C
10:00	34,5°C	35,5°C	36,4°C
11:00	31,5°C	32,1°C	32,6°C
12:00	29°C	29,7°C	29,7°C
13:00	27,2°C	28,4°C	27,7°C
14:00	26,5°C	27,4°C	26,1°C
15:00	25,7°C	26,6°C	25,5°C

*Picture 10: Results table for 3 different measurements during 8 hours*

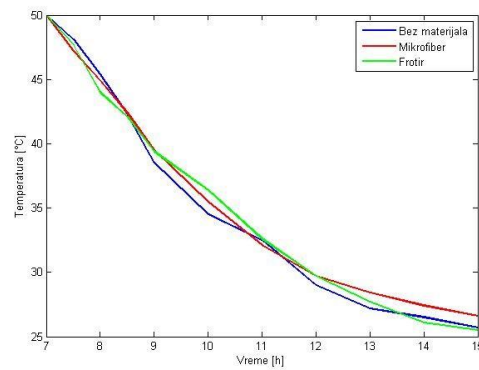
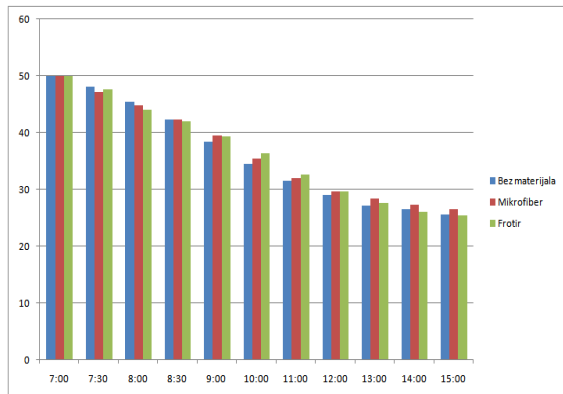

*Pictures 11 and 12: Graphs of the obtained results and their relationship are shown*

## CONCLUSION

After finishing the heat loss test on the graphs, it can be seen that the microfiber is better compared to the terry and, of course, the clay itself without a pillow, which in addition to other properties makes it the best for combining with thermal clay in thermotherapy. In combination with microfiber therapy, it can take longer and because of the absorption power, treatment is pleasant despite sweating.

## REFERENCES

- [1] Physical medicine, authors: Dr. Snežana Conić and Dr. Predrag Delibašić
- [2] Textile Materials, Authors: Djordic Branislav and Radeka Mirjan
- [3] Mechanics and heat, by: Petar Kalušić

# THE PROCESS OF EDUCATION OF EMPLOYEES IN CLOTHING INDUSTRY BASED ON EXAMPLE OF GERMAN COMPANY PIRIN-TEX

Marjanović Milica, P. Vasilije, M. Anita, J. Danka, S. Stanislava

\*Technical Faculty "Mihajlo Pupin", Zrenjanin,  
Đure Đakovića bb, 23000 Zrenjanin

\*Faculty of Technology Leskovac, University of Nis - The scholarship holder of the  
Ministry

e-mail:mmkastel@hotmail.com

## APSTRAKT

*In this work I will introduce you to process of education of future employees in clothing making company Pirin-tex. The future worker in productions lines in clothing fabrics has to go through education process before starting to work in lines. Since it is production of Prêt-à-porter clothes it brings certain standards and roles of production and quality of final products. The workers have to satisfy a certain level of work quality and knowledge before continuing to work in lines for sated norms.*

*Company Pirin-tex EOOD is in Bulgaria and it has 25 year of experience in clothing production in this factory and more than 50 years experience in clothing production industry. They make Prêt-à-porter clothes of high street brands such as : "Hugo Boss", „Stella McCartney", "GUCCI", "Givenchy", „Azzaro", "Laurel", "Tommy Hilfiger", "KENZO" and many others.*

*Company "Pirin-tex" EOOD made their own system of education employees, they have learning center as part of their production and there they teach and prepare employees for working in lines. The presented work is a result of internship I did in Pirin-tex EOOD during Summer 2018 where I learned all about their education process and went through part of it myself.*

## 1. INTRODUCTION

Fashion is a social phenomenon; the way people behave and present themselves in different aspects of social life. In modern world clothes and the way we dress plays big role in affirmation of a person. Everyone has their public "I" that they show to the public and there private "I" that they are really. The public "I" is the impression that person makes on other people with the way they behave and the way they dress. Fashion and clothing are one of main representors of a human, his individuality as well as the class they belong to.

Humans started dressing out of basic need to protect themselves from things as: rain, snow, sun, wind, heat, cold, but that changed with time as humans evolved and clothes become status symbol.

Fashion has always been more of a women thing, and it has almost been a role that women pay a lot more attention and time to their appearance and to this phenomenon in general.

## 2. ABOUT THE COMPANY PIRIN-TEX EOOD

"Pirin-tex" EOOD is company that produces Prêt-à-porter clothes of high quality for man and woman of world known brands such as: "Hugo Boss", „STELLA McCARTNEY", "GUCCI", "Givenchy", „Azzaro", "Laurel", "Tommy Hilfiger", "KENZO" and a lot other brands that have high standards for quality of their products and that are present and highly rated on world fashion market.



Most of these brands have Haute couture as well as Prêt-à-porter collections that are partly produced in Pirin-tex.

Production is based in Bulgaria, and it is working successfully for 25 years. "Pirin-tex" is a subsidiary of „Rollmann & Partner Fashion Management“ GmbH – an enterprise with a nearly 100 years of history in garment production.

The company started working 1922 when Georg Rollmann opened a small home based tailor's workshop together with his wife. The work was developing well and in 1949. was taken over by their son Alfred.

There first production was opened in 1965 in the city called Kleestadt in Germany, ten years later they opened another one in Schaafheim. In 1980. they opened a production in Greece in Katerini, and after that in 1993 in Bulgaria in Gotse Delchev.

Production in Bulgaria employees today about 2000 people. Manufacturing facilities cover an area of 23 000 sq.m. and include 10 production lines. In addition to this they have their own washing & dyeing house for finished garments which makes production much more efficient.

The production is equipped with state-of-the-art machines and specialized equipment assuring high levels of flexibility and efficiency in production process.

It is supported by IT-systems, specially developed by their company. That allows full traceability of every single piece. All this combined with the experience and professionalism of employees guarantees the impeccable quality of products.

They produce the orders in shortest possible time and provide optimization of costs of ordered products.

The production works in two shifts and beside the workers from the city of Gotse Delchev the company employees a lot of people from villages around and provides them transportation to work.

Highly qualified employees provide fast realization of orders and quality of products of different difficulty for both man and woman clothes.

They started educational center for future workers in 2011 (mostly younger people from the city) which showed how much they value quality of employees in there company and justified high rating they have in industry.

With this they have shown as well interest in local community and inhabitance, especially youngers and there future in their hometown.

Fashion industry is one of the biggest polluters of planet Earth. In Pirin-tex they are aver of this so they have developed program of care of environment and protecting the nature as well as recycling .

In a specially adapted department they gather, sort, and bale over 95% of their textile, paper and plastic waste, and sell it as raw materials for the recycling industry.

They even have the wastewater treatment plant. Their waste water from washing & dyeing department is purified mechanically, chemically and biologically and undergoes constant control against residues.

They have developed an excellent work system, communication between the firms that order and company management is on high level which provides successfully done work in shortest possible time.

Annual production is more than 1 million clothing pieces.

Company goals:

- to be garment producer №1 in Europe
- to be one of the drivers of innovations and technological progress in their sector
- to turn Industry 4.0 into reality in our production
- to provide for our young specialists long-term perspectives and good labor conditions
- to protect the nature, our employees and our clients from any harmful impacts from our activities

Director of company is Mr.Bertram Rollmann who has several decades of experience in production in fashion industry.



*Picture 1 and 2: production of Pirin-tex in Bulgaria*

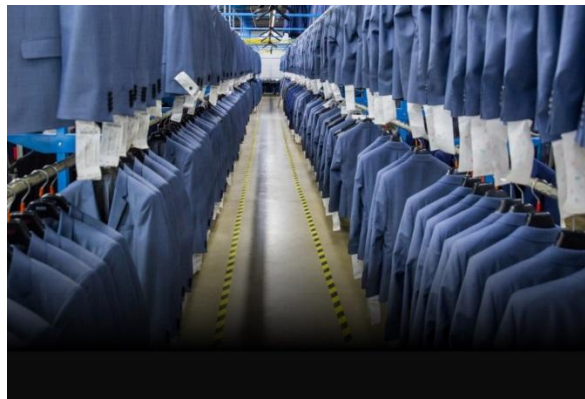

*Picture 3: Warehouse of production*

### **3. FASHION IN 20.CENTURY AND ABOUT PRÊT-À-PORTER**

Fashion in 20.century like all other industries, social phenomenon and types of art were affected by wars and shortages. Because of this fashion, especially female, was oscillating from spearing every inch of fabric to absolutely not taking care of how much meters of fabric is needed for only one skirt.

In last few decades nothing changed as much as women's fashion did, as women emancipated, got working positions and become independent the fashion followed. Fashion followed and was inspired by innovations, technological progresses, politics, culture...

In that way we can follow exact development of fashion trends, and with that we recognize typical salute's, forms, cuts and changes that happened gradually with time.

First decade of XX century symbolizes the liberation of women from corsets which weren't functional and weren't healthy.

They were pushed-out with new and much more practical clothing pieces. Exactly with that revolutionary change, at that time, starts the history of contemporary clothing. At that time tendency was developed: to make clothes, especially for women, fashionable and functional, to follow women's silhouette and not to interrupt normal body movements.

In 1960s, Haute Couture controlled the trends of world fashion, but the age of mass consumer society was fast approaching. Prêt-à-porter arrived to meet the need of a large market with good quality products. Ready- to- wear clothing had been available since the end of the 19<sup>th</sup> century, but it was considered cheap and poorly made. In the 20<sup>th</sup> century, with the advance of a mass culture and manmade materials, prêt-à-porter gained respect and popularized fashion. In 1973, prêt-à-porter designers started showing collections in Paris twice a year, following similar schedule Haute Couture. Such collections have been held in Milan and New York since the mid-1970s, and London, Tokyo and other cities were not slow to follow.

Prêt-à-porter is clothes that is fashionable, high in quality and adjusted to everyday life of successful people.

#### **4. SAWING MACHINES**

The most known brands of sawing machines are: Singer, Brother, Juki, PFAFF, Bagat, Typical.

Pirin-tex in there production and workers education uses some of these brands: Juki и PFAFF. The sawing machines that are used for educations of future workers have adjustable working speed. It doesn't matter how hard you press the pedal if the sawing machine is adjusted to work on minimal speed she will saw slowly, and if it is adjusted to work on maximum speed and you press the pedal very hard, the machine will saw really fast.

#### **5. THE PROCESS OF EDUCATION OF SEWERS AT PIRIN-TEX**

The process of education of a future worker starts with IQ test witch is done in factory offices.

Beside regular intelligence test that includes filling in the missing spots with adequate option there is also a skill test.

Based on results they estimate the workers affinities to certain operations, the ones he would do faster, better, more efficient, is he more for long or shorter seams.

After that he goes to education center where his training starts.

First they teach the new employee about parts of sawing machine and how it works: how to turn in on and off, how to put correctly the tread in machine in order to sew...

The worker on training than practices how to put the thread in machine by himself as fast as possible. Every phase is a separate step of training a new employee.

After that they get a long ribbon and the task is to "saw it " without thread. This assignment is for the worker to "feel" the machine, how it works, how hard the pedal should be pressed to saw in optimal speed, and to "feel" the fabric. The "sawing" is done in different directions.

To make the seam the thread is needed. The quality of product doesn't only depend on quality of the seam but the choice and quality of the thread used to make it.

The next phase and assignment is to make hand stiches. The workers need to learn how to do various different hand stiches as precise and even possible.

Some of the stiches are: machine stich, invisible stich, zig-zag stich, chain stich and more.

When worker start the training on sawing machine he continues to do hand stiches as well, as break from sawing on the machine for 1-2 hours per day.



Picture 4: the picture of hand stiches assignment

## 6. EXERCISES ON PAPER PATTERNS

After hand stich exercises it comes sawing on sawing machines.

First step of education is done on paper exercises. The sewer gets the assignments on paper where is certain pattern printed on and he should do it in assigned time. There is determent number of mistakes that is acceptable to make on each exercise. The exercise is repeated until is done in assigned time with aloud number of mistakes.

I passed throw this exercises on my first day of internship in Pirin-tex.

Exercise one:

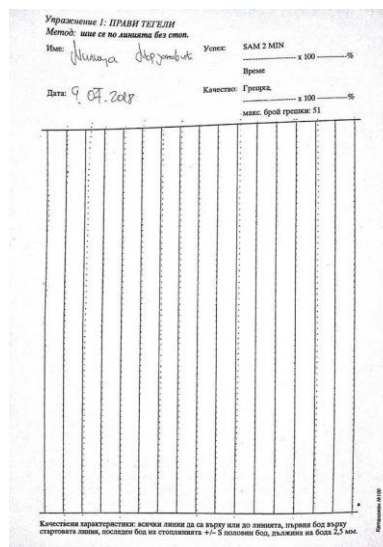

Picture 5: first exercise

The assignment is to saw strait lines over lines on paper, with the least possible oscillations and deviation from printed lines.

Each exercise is different, has different shapes and patterns to be sawn such as labyrinth, or concentric continues circles, zig-zag lines or waves.

The exercises gradually become harder and make worker saw more independently given shapes. The assignment on last exceses starts on number one. The assignment is to saw over printed lines, as helping lines gradually desappear the assignment stays the same, to saw the “corners”.

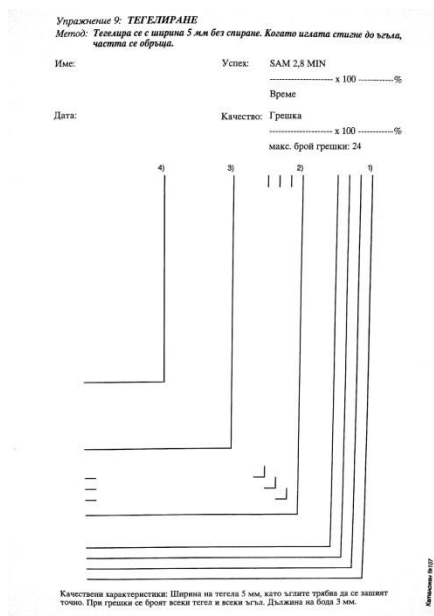

Picture 6: last exercises

After successfully finishing the paper sawing assignments the training passes to sawing on fabric.

## 7. SAWING ON FABRIC

First assignment on training on sawing machine with fabric is to saw over fabric on distance of 0.5cm until all fabric is stitched. After that turn the fabric and do the 3cm seam, continue doing it on 1cm distance until the end of fabric, than continue in next line, and so on until finishing whole piece of fabric.

When the worker on training masters this task he continues to the next one. This is the principle valid for every step of education. Next assignment is decorative seam of 0, 2 cm of each side of the seam, after that the task is 0.2cm and then 0,5cm.



Picture 7: decorative seam 0.2cm than 0.5cm

Each assignment is a bit more difficult and demanding than the previous one. Tasks are various decorative seams, sawing in different thickness of rubber bands.



*Picture 8 and 9: examples of decorative seams and rubber band tasks*

## 8. DETAILS ON CLOTHES

Basic parts on clothing items are the ones without which the clothing item wouldn't exist. Details are decorative parts of clothing pieces and can be changed, used or not without changing the basic use of the item. Under details we consider those elements on clothes that can be changed without changing the elementary purpose of the item.

Details on clothing are: different kinds of pockets, collars, slips, cuffs, waistbands, etc. Details on clothes make them prettier, more functional, and make them different.

The details that are done on training are: patch pocket, jetted pocket (one and two jetted), flap pocket, angled pocket, collar, elbow patches, zippers on pants and sawn up zipper on dresses. After details, next assignment is to sew whole clothing piece, usually man pants or bermuda shorts.

The length of training is individual and depends on a person and his own progress. The trainer follows the progress of each trainee and, based on his progress and abilities, directs him and gives him assignments.

After the training is done, employee can stay in education center for a while, there they do less demanding operations, work under control and can get help if needed.

Basic training can last up to one year, after that the trainee is transferred on specific operations in production lines where he starts working with all other workers on given norms.



*Pictures 11 and 12: examples of various pockets and zip on pants*

## 9. CONCLUSION

Working in a fashion industry is not nearly as glamorous as its products.

Behind each Prêt-à-porter garment is a lot of production operations and work with average buyer is not aware of. He is investing in Prêt-à-porter clothing piece, but beside the brand, the good quality sells it.

For expected quality, besides fabric, each detail plays big role. Every phase of production of a model is important, from its pattern, thinking about every esthetical and practical detail of a garment to a detail checking of every element and every seam on the end.

In order to make this possible industry needs qualified workers that know the Prêt-à-porter standards and can pursue the designers idea and make a clothing item. Checking each and every production phase is a key of a quality.

This job is very demanding, responsible and in the beginning can be really stressful, until workers get used on working in line in demanded speed and work in production itself: in loud surroundings, a lot of people and fabric dust.

An extra pressure can be to finish your assignments on time because coworkers depend on you; they have no work if you don't finish your in time! Chain work is a base of functioning a fashion production system of work.

The most important link in the chain are sewers who have, beside making high quality seams, "fight about time" every day. Behind them are their trainers and supervisors who are controlling the production process and products. As a result of their team work we have high quality products on fashion shows and in shopping windows.

## 10. REFERENCES

- [1] Техничке информације предузећа "Pirin tex", 2018.
- [2] V.Petrović, M.Gašović:Modna kolekcija, Tehnički fakultet „Mihajlo Pupin“, Zrenjanin, 2016., ISBN 978-86-7672-257-0, COBISS.SR-ID 299045383
- [3] 3.V. Petrović: European Textile Platform for the Future of clothing and Textile, Regional Textile conference "Sustainable development of the Textile Industry in Republic of Macedonia", Ministry of Economy of Republic of Macedonia in cooperation with Faculty of Technology and Metallurgy, University "Ss. Cyril and Methodius", 04 - 05 October, 2012., Skopje,Macedonija,
- [4] Costume and fashion a concise history, James Laver
- [5] V. M. Petrović: (2006), Savremene tehnologije u odevnoj industriji,II Naučno-stručni skup Tekstilne industrije Zapadne Srbije, Regionalna privredna komora Užice, 21-23. septembar 2006.godine, Ivanjica
- [6] Fashion from the 18th to 20th century, The Kyoto Costume Institute
- [7] V. Petrović, J.Stepanović, M.Stanković, M. Reljić, S.Stefanović:Savremena kretanja u tekstilnoj i odevnoj industriji u Evropi, Menadžment, Inovacije, Razvoj, Volume 8, No.1, str. 83 - 89, (2013). UDK005, ISSN 1452-8800.
- [8] V. Petrović: (2004), Pravci razvoja odevnih firmi u funkciji osposobljavanja za brze odzive na zahteve tržišta zemaljavelih potrošača odeće , I Naučno-stručni skup Tekstilne industrije Zapadne Srbije, Regionalna privredna komora Užice, decembar 2004.godine, Arilje, str.12-20.
- [9] D.Rogale, D.Ujević, S.F.rogale, M.Hrstinski: Procesi proizvodnje odjece, Tekstilno Tehnoloski fakultet, Zagreb, 2011
- [10] Проф.др.сц. Дубравко Рогале,проф.др.сц. Дарко Ујевић, доц. Др. сц. Сњежана Фиршт Рогале, Маријан Храстински, Процеси производње одеће
- [11] Јасминка Петровић, Технологија одеће, 2010.год
- [12] www.google.com

## THE USE OF THREE-DIMENSIONAL KNITTED MATERIALS

Anita Milosavljević, V. Petrović, D. Joksimović, S. Sindelić

\*Faculty of Technology Leskovac, University of Nis - The scholarship holder of the  
Ministry

\*Technical Faculty "Mihajlo Pupin", Zrenjanin,  
Đure Đakovića bb, 23000 Zrenjanin  
mail: [anita.milosavljevic@hotmail.com](mailto:anita.milosavljevic@hotmail.com)

### ABSTRACT

*The shape of textile materials or products is important factor in the phase of planning because it affects the selection of raw material, structures and technologies. The need for products with complex shapes requires adaptation of textile materials and leads to the 3D concept of materials and architecture .*

*Considering their big use and need of three-dimensional knitted materials, in this paper are described the characteristics of three-dimensional knitted materials, their production and the the most abundant areas of usage such as medicine. Especially because the demand and interes for these materials are in constant increase and that is because great strength and good quality they have. They are massively used in care and treatment of patients in the health institutions. Thanks to 3D structures of knitwear the best quality of products is accomplished. It leads to much bigger usage for medical purposes. The big number of new 3D knitted materials are in constant development so they can suit the multifarious medical request. However, there are still challenging questions about the products implanted in human body, and because of increase of the market they are the subject of this paper.*

**Key words:** knitwear, 3D knitted materials, medicine.

### 1. INTRODUCTION

The technology of knitting is one the future development areas of high technology research and usage. The use of knitting products hihg technology is constantly in growth, especilly as composites for engineering purposes. This textile products can provide advantages of high quality respectively the strengh.

The shape of knitted materials/products is an important factor in the fase of projecting because it influences the selection of raw materials, structure and technology. The need for the complexly shaped products requires adaptation of textile materials. That is bringing us to the concept of 3D materials and 3D architecture. The idea about 3D shaped textile knitted product isn't new, but in the beginning the use of editing technology was default. Tenological development of the last decades and introducing CAD / CAM systems in production, enables production of more complexed shape of 3D knitwear. Today, there are 3D knitwear in different shapes. This are products of multiplex shape with high level of usage.

Based on characteristics, usage and need for three-dimensional knitted materials in this paper work will be described the production and the most represented areas of usage. The demand and interes for three-dimensional knitwear is in constant increase because of the strengh and the quality they show, particulary in medical areas of use. They been used massively in care and curing patient in health institutions. It is a new chapter of usage textile technology products in field of medicine. Thanks to textile structures and high quality three-dimensional knitwear products have great practical value and usage in medicine.



The technology of knitting and three-dimensional knitwear materials are the future of development high technology and researching the textile products in the field of medicine.

Knitted medical textile is an increasingly popular trend in technical textile. Big number of structures and materials are in continuous growth so they can fulfill all the necessary conditions for the use in medicine. Still, there are questions about textile materials implanted in human body. With an increase of older population, there is an increasing of number of injuries old people aswell. On another hand, the demand for higher quality of life is bringing to the need of wide assortment products from the group of knitted medical textile. These products must fulfill vital demands and high level of quality in usage three-dimensional knitwear in the field of medicine.

## **2. DEVELOPMENT OF KNITTING TECHNOLOGY OF THREE-DIMENSIONAL PRODUCTS**

Knitting is the most flexible technology which can control individual setup of yarn ( by holding, transmitting and retrieving ) making it ideal for controlling mechanical characteristics of guidance for certain burden.

In the last couple of years the use of 3D knitted products in great extent affects development and advancement of medical products for protection. Before 3D technique of shaping knitwear, the knitted materials were easy to stretch so they can adjust certain shape. That influenced deformation of the structure of the knitwear. However, the modern production and 3D technique provides easy creating and designing structure of 3D products of different shapes.

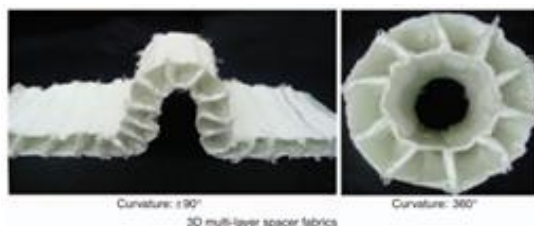

*Image 1. 3D knitted shapes of material*

### **2.1. Characteristics and use of 3D knitted materials**

Characteristic of some 3D knitted materials is the layer of yarn inside of the structure of the material. This kind of knitwear has very high thickness and reinforcement. They are made from two independent materials which are connected with yarn or knit layers.



*Image 2. Examples of spaces in knitwear with closed and opened structure*

Important characteristic represents volume of fibers for shaping the structure of knitwear. Beside this characteristic, from some knitwear is possible to get 3D geometry through shaping knitwear, usually when the process of knitting is done with more than one needle or to be specific, with corresponding number of needles.

That kind of shaping knitwear is based on need for producing materials with complex form which are the same or at least similar to the final form of final, needed and required product. Spacious structured shaped material has to match 3D form of final product which will be produced from them.

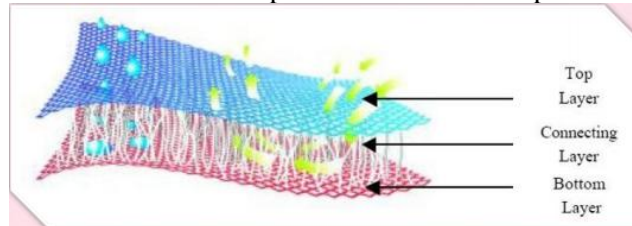

*Image 3. Display of three-dimensional knitted structure*

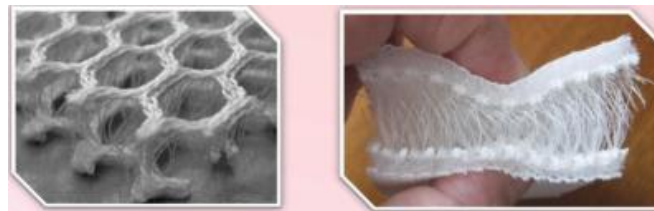

*Image 4. Display of 3D knitted shapes*

Trodimenzionalna pletena struktura ima brojne prednosti. Neke od njih su dobra prozračnost i protok vazduha kroz samu strukturu pletenina, imaju dobru toplotnu regulaciju i veliku otpornost na vlagu. Zbog svih ovih karakteristika i prednosti, ovakva pletena struktura je posebno potrebna u medicini gde i ima veliku primenu. Njihovom primenom u medicini i zdravstvenoj zaštiti može se postići veliki napredak. Zbog toga se 3D pletenine sve više primenjuju u medicini i za postizanje boljeg kvaliteta npr. zavoja, zaštitnih rukavica, uložaka za obuću, hirurških materijala... U nastavku rada će biti opisana primena, osobine i prednosti takvih 3D materijala.

### 3. 3D BANDAGES

Regarding big usage 3D knitweaves exactly in the fields of medicine, unavoidable is use of 3D bandages. 3D bandage is considerably better and higher-quality than regular bandage. This bandages are providing appropriate advantages because during the use they are spreading evenly all the pressure on the skin and doing that, they are providing to the skin and injuries equal flow of the air.



*Image 5. Commercial double layered bandage for cladding*



*Image 6. Modern 3D bandage*

### 4. The use of three-dimensional materials in orthopedy in the footwear interior

The use of three-dimensional knitwear in the shoes production is increasing as well, and it's because of the comfort that provides during the shoes wearing.

They are providing material comparability of compression, and beside that the 3D knitting insoles can be washed, used again and they are even biodegradable.

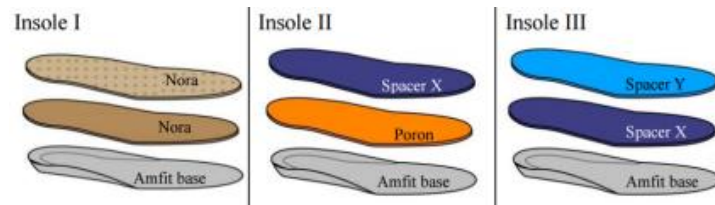

Image 7. Insoles from different combination of material

3D knitwear can be shaped easily, they have better performances such as heat exchange and wetness and transparency. They have possibility to prevent different skin diseases while providing compression and heat.

## 5. THE USE FOR PROTECTIVE GLOVES AND OTHER FIELDS OF MEDICINE



Image 8. Original model of gloves



Image 9. Gloves from 3D knitwear

Protection gloves made from 3D knitwear, as well as 3D bandages, are providing for skin to have better comfort, good air circulation, absorption and properties of wetness. Medical textile in combination with 3D knitwear provides great strength. Because of this characteristic it is recommended to be used in surgery and implants.

Surgical products which can be implanted during the surgery, when with 3D knitwear, are much more lighter, flexible and have more durability.

It is noticeable big usage of 3D knitwear with orthopedic implants. They can be combined with elastic wires and they can improve the growth of bones, reduce micro-moves and provide higher strength of implants.

Excellent physical and versatile properties of 3D knitted materials are providing possibility for combinations with other materials in many products (mattress, pads, orthopedic products, clothes for the therapy under the pressure, absorbic medical textile, products that protect the environment, materials for protection from orthopedic implant and many others). Based on all this in the continuation of this paper the most abundant areas of usage 3D knitted materials are more detailed described as well as the way of their usage and way of production.

## THE MOST COMMON AREAS OF APPLICATION 3D KNITWEAR IN MEDICINE

Fields of medicine are the most demanding and application of three-dimensional knitwear is the biggest right here. Medical textile are textile products that are used in massive care and curing patients in health institutions. It is a new chapter of cooperation between textile technology and medicine as a science. 3D knitwear are used in many other fields. Because of need for this high quality materials and big use of medical materials the further description continues.

Medical materials with 3D knitwear are giving great values to the products and in that manner textile materials have big practical usage in the medicine. Medical knitted materials are usually made from natural fibres such as cotton and ramie, but with growth of technology sintetic fibres are having usage as well in medical textile

Beside knitwear, medical textile products are made from non-woven materials. Non-woven medical textile is more than 60% from total assortment of medical textile products. Products made from non-woven materials usually have one-time use in medicine.

Compared with woven materials, knitwear have loose structure, good flexibility, high transparency, so they can be shapened in the form of human body. Flexible structure knitted materials can vary so they fulfil different demands and they are adjustable to be applicated in medicine, especially in high quality medical textile. Knitwear applicated in medical use involve for example bandages, coating of medical mattress, cloth for surgery and other sertain high technologies, but they are also used as medical organ for implanting in human body

## 6. STRUKTURE OF KNITTED MATERIALS

Different types of machines, structures and types of loop, yarns and types of needles are used for producing 3D knitted materials with different properties.

Knitting is known for its way of forming loops and bigger possibilities for getting multifarious structures of knitting materials. Knitted materials have great indulgence and high conductivity. The siye of loops can be different and flexible. Knitwear with three-dimensional structure are high-quality so they can be produced on special machines for knitting.

On image number 12. is shown forming knitted materials, and on image number 13. 3D forming of knitwear.

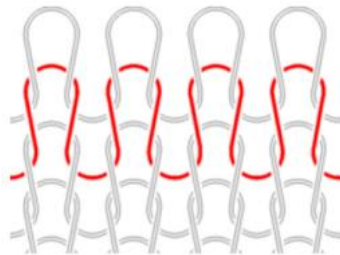

Image 70. Basic display of knitwear

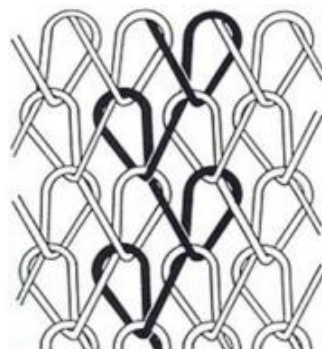
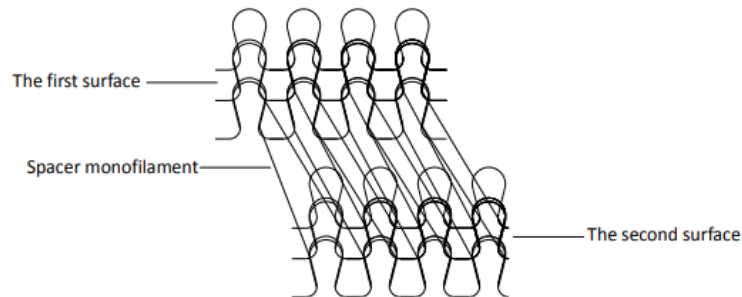
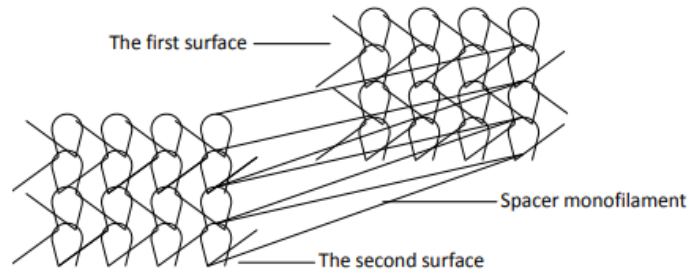

Image 11. Displaying the knitting pattern (basic knitting pattern)



*Image 12. Shows the formation of knitted material*



*Image 13. 3D display of knitting*

## **7. KNITTED 3D MEDICAL TEXTILES**

In this paper work is mentioned implant textile that mostly includes medical resources such as gauze, bandages and other textile that comes in contact with skin and wounds. They are used for covering the wounds and their protection, preventing infection and helping during the treatment.

Medical textiles must isolate and prevent different infections, protect the wounds, keep medicines while adding medication to the wound and absorb the fluid. It is necessary for wound dressings and has the properties of good hygroscopicity, good airiness and a great feeling of comfort when it comes into contact with the skin. Knitted medical materials exhibit greater elasticity and flexibility, often have absorbent layers for good heat control and moisture transfer.

## **8. 3D KNITWEAR FOR USE WITH MEDICAL BANDAGES AND LINING**

Common ribbed knitwear have high elasticity and stretchability when they grow in the opposite direction. The combination of mesh knitted and ribbed, has advantages such as stability and structure of a larger thickness.

Often knitwear can be used in such knitwear, for example new regenerated cellulose fibers with excellent antibacterial properties. These are ecological textile fibers, they are healthy and currently very present, they show great potential in medicine for the linings themselves. These are ecological textile fibers, they are healthy and currently very present, they show great potential in medicine for the linings themselves. Medical bandages can be knitted from blends or can be 100% cotton fabrics.

## **9. 3D KNITWEAR ARTIFICIAL BLOOD VESSELS**

Knit structures are often used to make artificial blood vessels because they have stable structures and high compliance. The pictures below are showing that; in the image 22. 3D knitwear artificial blood vessels and in image 23. some of the artificial blood vessels structures.

The materials used for artificial blood vessels are: polyester, polypropylene, polyethylene and other synthetic fibers. Silk fibron is also used for high strength and toughness. Specifications are variable because they are applied in different shapes.



*Image 14. Some of the artificial blood vessels structures*

In addition to blood vessels, they also have different implants. Implants to assist in the treatment of hernia and polymer mesh are often used in surgery. It is characteristic that they have small pores, and in this way the structures have a higher strength and greater stability. Materials include non-absorbent polymers, polyester, polypropylene, etc.

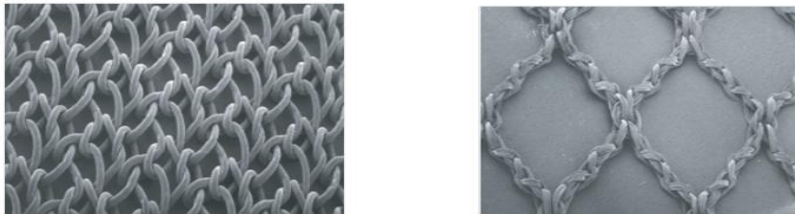

*Image 15. Knit structures for the treatment of hernia. (a) With small pores; (b) With large pores*

## 10. ARTIFICIAL LIGAMENTS

Artificial ligaments can be used to replace damaged knees. The studied arc enhancement system is widely used in the front ligament reconstruction. This material is a medical polyester and the basic structure is knitted. As shown in picture. 25, the longitudinal fibers are bonded together with the cross-knit structure. The longitudinal fibers are parallel and pre-twisted at an angle of 90°. According to the number of fibers, ligaments have different sizes and are used for different purposes. Some ligaments may have a lower distribution, but greater tensile strength, high endurance, and this leads to satisfactory clinical outcomes.

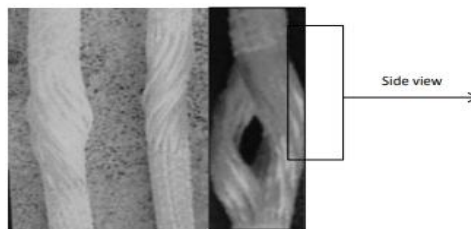

*Image 16. Display of ligaments*

## 11. MATERIALS THAT HELP WITH HEART DISEASE

Materials that help with heart disease are elastic nets with knitted bags, which are cut and sewn based on heart shapes. The basic structure of the material also contains a multilayer yarn that provides high strength and thickness while maintaining flexibility. Materials of this type with braids are excellent for application and are easily placed on the surface of the heart to provide acute support for the wall.

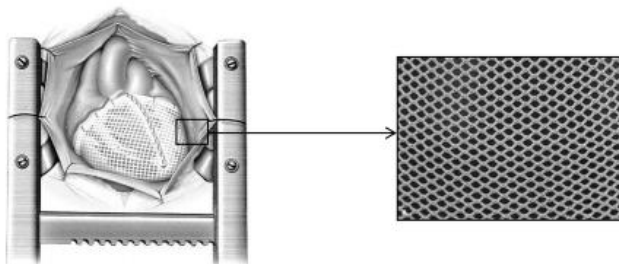

*Image 17. Positioning and providing assistance in heart disease*

The mesh is made of knitted materials. Image 27. (a) shows the material with small-thick loops. Image 27. (b) shows material with large - rarely knit loops. Their basics give the material a certain elasticity, durability and different mesh sizes can be made from it.

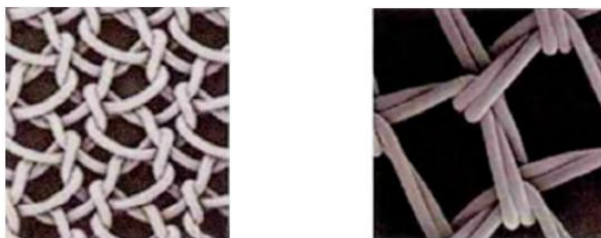

*Image 18. (a) Materials with small loops - thick knitted meshes; (b) Material with large loops - rarely knitted netting*

## 12. ARTIFICIAL CHEST WALL

The artificial chest wall is used extensively in the chest wall for its reconstruction. Two basic knitwear are used. Because of their good resistance properties, they protect and prevent growth, for example. tumor issue.

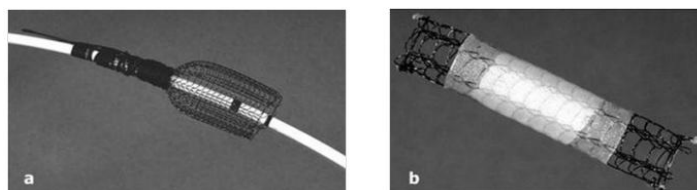

*Image 19. (a) Self-sealing wall to the final diameter; (b) a wall for preventing the growth of tumor tissue*

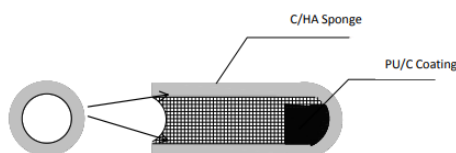

*Image 20. Structure of the artificial chest wall*

## 13. APPLICATION OF 3D TEXTILES FOR THE PRODUCTION OF MATTRESSES

Knitting technology is one of the most economical and most interesting technologies for creating three-dimensional materials.

It's interesting that we have medical mattresses. To a large extent, knitwear is used as a pillow case, due to its stable structure, low weight, good permeability, good compression and resistance. The materials are knitted on rash machines. They can also be used as an anti-stress mattress, a surgical foundation, and a mattress on wheelchairs. They are extremely resistant, high quality and rigid structures.nce.



*Image 21. 3D knitwear for production of medical mattresses*

The mattresses are coated with materials that have good permeability, moisture absorption, as well as elasticity and good temperature regulation.



*Image 22. 3D knitted material*

## 14. CONCLUSION

According to all data and characteristics it can be concluded that the shape of textile materials / products is an important factor at the design stage, as it affects the selection of raw materials, structure and technology. The need for products with a complex shape requires adaptation of textile materials and leads to the concept of 3D materials and 3D architecture.

Taking into account their great application and the need for three-dimensional knit materials, this paper describes the characteristics of three-dimensional knit materials, their production and the most common areas of application such as medical. Especially because demand and interest for them are constantly increasing due to the high strength and quality they provide. They are used massively in care and treatment of patients in health care institutions. Thanks to the 3D structures of knitwear, better product quality is achieved. This leads to increased use for medical purposes. A large number of new 3D knit materials are constantly being developed to meet the requirements for diverse medical requirements. However, there are still challenging issues for those products that are implanted in the human body, with the increased need for them and what is discussed in this paper.

## 15. REFERENCES

- [1] D. Trajković: Designing knitwear, University of Niš, Faculty of Technology in Leskovac. Leskovac, 2009.
- [2] V.Petrović: Knitting technology, Technical faculty „Mihajlo Pupin“, Zrenjanin, 2000.



- [3] A review of three dimensional knitted spacer fabrics for medicine and healthcare and recent developments - Authors: Ms. Shuk Fan TONG<sup>1</sup>, Dr. Joanne YIP<sup>1</sup>, Dr. Kit-lun YICK<sup>1</sup>, Prof. Marcus Chun-wah YUEN<sup>1</sup> <sup>1</sup>Institute of Textiles and Clothing, The Hong Kong Polytechnic University, Hung Hom, Hong Kong
- [4] Abou-Taleb, H.A. (2014) 'Spacer fabrics for soft but strong knee braces', *Textile Asia*, 45(2), pp. 37-42. Abounaim, M., Hoffmann, G., Diestel, O. and Cherif, C. (2010) 'Thermoplastic composite from innovative flat knitted 3D multi-layer spacer fabric using hybrid yarn and the study of 2D mechanical properties', *Composites Science and Technology*, 70(2),
- [5] Bartels, V. (ed.) (2011) *Handbook of medical textiles*. Elsevier
- [6] Bruer, S. M. and Smith, G. (2005) 'Three-Dimensionally Knit Spacer Fabrics: A Review of Production Techniques and Applications', *Journal of Textile and Apparel Technology and Management*
- [7] Davies, A. and Williams, J. (2009) 'The use of spacer fabrics for absorbent medical applications', *Journal of Fiber Bioengineering and Information*

## OPTIMIZATION OF THE PRODUCTION OF CHILDREN'S CLOTHING ON THE EXAMPLE OF "FORMA VS"

**Maja Kostić, V. Petrovic, A. Milosavljevic, D. Joksimovic**

\*Technical Faculty "Mihajlo Pupin", Zrenjanin, - Đure Đakovića bb, 23000 Zrenjanin

\*Faculty of Technology Leskovac, University of Nis - The scholarship holder of the Ministry

mail: [maja12345666@gmail.com](mailto:maja12345666@gmail.com)

### ABSTRACT

*Company "Forma VS" exist more than a decade, is located at the top of the wholesale of clothing and accessories for children, haberdashery and repro materials. In the company headquarters are carried out all production processes related to the manufacturing of children's clothing such as design, construction, tailoring, printing, embroidery, sewing, ironing, packing and distribution. In this paper we investigated only a small part of clothing items belonging to the children's clothing from a wide range of clothing products. In this work will be included product development with practical work from which is made operational list for tailors, sewing and finishing. Three models which are covered below are: sweatshirt for girls, T-shirt for boys and bodysuit for boys that belong to the brand "Jungle".*

### INTRODUCTION

The company "Forma VS " is located in Belgrade in settlement Labudovo brdo. The company has its own brand "Jungle" which owns two lines: Jungle baby and Jungle junior. The emphasis is on comfort which ensures free movement necessary for proper growth and development of children. In addition to the brand Jungle, the company after many years of preparation and development in 2012 began production of the brand "My Baby." "My Baby" brand is moving in two important directions: production of soft, comfortable and high quality clothing for babies and on the other hand the creation of modern models for boys and girls up to the age of 10. The brand for children is divided into two sub-brand "Magic Girl", who with care listens to the needs of girls and comes out to meet them with comfortable, modern cuts for everyday and "4ME", designed clothing for boys for everyday events: school, sports, hanging out.

### TEHNOLOGICAL PROCESS OF MANUFACTURING CLOTHES

Technology analysis of making garments leads to the breakdown of working processes, division of labor and specialization of workers for individual technological operations. Different number and different types of technological operations of clothing require division manufacturing process of clothing, according to the types of clothing in four technological areas, each area of technology components in the technology groups:

1. Technological process of men's upper clothing (suits, pants, sportswear, etc.).
2. Technological process of the female upper clothing (jackets, pants, skirts, dresses and etc.)
3. Technological process of service (male, female, bed linen)
4. Technological process of knitted apparel (upper knitted garments and knitted underwear)

The process of the industrial production of work clothing are divided into:

1. Production preparation
2. Technological process of cutting
3. Technological process of sewing
4. Technological process of finishing

The technology process of making clothes, in our case sweatshirt for girls, T-shirts for boys and baby sets, requires a series of stages of work to make a garment created in the required quality. The build quality of garment is not only reflected in the original appearance but also in the quality of materials, quality finish, auxiliary materials, zippers and snaps.

## **TECHNICAL PREPARATION OF PRODUCTION**

The purpose of the technical preparation of production in the apparel industry is that, before you start creating a new garment, you must study the properties of materials to be applied, then the possibilities for conditional production, in order to come up with a minimum expenditure of labor, driving energy and materials reached maximum effect. Technical preparation of production has even greater importance in planning and carrying out mass-produced garments. The task of production preparation is to establish all the circumstances of production to the process taking place normally, without improvisation. Production preparation consists of four organizational units:

1. Construction preparation
2. Operational preparation
3. Technological preparation
4. Material testing

## **TECHNOLOGICAL PROCESS OF WORK**

When you are preparing the design of new production you must know that on the basis of consumption of textiles in the industrialized countries, today's consumers have very high demands in terms of quality products that would satisfy the physiological and useful function.

In the organization of the technological process of sewing must know which garment is the target of making, because every item special and, as such, requires special organization process of sewing. It is important to choose the right technology operations when creating clothes because it shortens the time of construction, allows a good flow of products through all stages of production, reduce production costs, and more.

The stages of the technological process of making clothes

1. Technical preparation
2. Technological process of cutting
3. Technological process of sewing
4. Technological process of finishing

### **Mode, enterprises Form VS:**

1. Number of working days in the month: 24
2. Number of working days per year: 312
3. Uumber of shifts: 1
4. The total number of working minutes a day: 450 min po radniku

*Table 1. Production capacity*

Model	Daily capacity	Annual capacity	Production line
Sweatshirt for girls	1 100	343.200	First
T-shirt for boys	1 900	592.800	Second
Bodysuit for boys	1 800	561.600	Third

### 3.1. Model 1. Sweatshirt for girls



**Picture 1. Sweatshirt for girls**

Based on the needs of investors and analysis of technological production process sweatshirt for girls, as well as the state of the market, was adopted technological product line for girls. Production of 1,100 pieces per shift is optimal.

#### **Model description:**

It consists of 11 cutting parts. The long sleeve, with the length of the sleeve renders clothes, and the neckline. Flounce on the sleeves. Knitting above renders. Printed on the front.

*Table 2. Cutting parts*

The main and auxiliary materials	Number of pieces in pattern picture
Front piece	1
Back piece	1
Gornji deo rukava	2
The upper part of the sleeve	2
Render length	1
Render neckline	1
Render sleeve	2
Roll	1

Forma VS Belgrade		Operacion technologically sheet - Art 2062 Model name: Sweatshirt for girls			
Article - 2062		<b>Model description:</b> It consists of 11 cutting parts. The long sleeve, with the length of the sleeve renders clothes, and the neckline. Flounce on the sleeves. Knitting above renders. Printed on the front.			Size: 2, 3 ,4 ,5, 6
Op. nu mb er	The means of work	Operation name	Norm (piece/450 min)	Operation number (seo/piece )	Production time (min/piece)
<b>Cutting</b>					
1	PR	Manually laying a material on the pattern layer	1800	15,00	0,25
2	RR	Setting pattern picture on pattern layer	2700	10	0,16
3	PA	Rough cutting	46000	0,6	0,01
4	Bansek	Fine cutting	900	30	0,5
5	RR	Packing of cut pieces	818	33	0,55
Total time					1,47
<b>Silk screen</b>					
1	RR	Printing on the front	900	30	0,5
<b>Sewing room</b>					
1	OV	Facing roll	1200	22,50	0,38
2	TP	Bonding the size number on roll	2400	11,25	0,19
3	OM	Sewing roll on the back	800	33,75	0,56
4	OV	Sewing shoulders stitches	1300	20,77	0,35
5	OM	Preparation of the rendering	1300	22,77	0,35
6	OV	Sewing renders	350	77,14	1,29
7	OV	Facing flounce	1200	22,50	0,38
8	OV	Sewing flounce	1000	27,00	0,45
9	OV	Sewing the upper and lower part of the sleeve with the insertion of flounce	250	108,00	1,80
10	OV	Interlocking sleeve	600	45,00	0,75
11	OV	Inserting labels	600	45,00	0,75
12	OM	Preparation render for sleeves	1000	27,00	0,45
13	OV	Sewing render	520	51,92	0,87
14	IBO	Production of knitting above renders sleeve	800	33,75	0,56
15	OM	Prepares renders length	1300	20,77	0,35
16	OV	Sewing renders length	700	38,57	0,64
17	IBO	Production of knitting above renders length	900	30,00	0,50
18	IBO	Sewing tape in the neckline	1000	27,00	0,45
19	OM	Closure strips neckline	700	38,57	0,64
<b>Finishing</b>					
			Total time of sewing		11,69
20	PP	Pressing sweatshirt	900	30,00	0,50
21	RR	Bonding declaration	4000	6,75	0,11
22	RR	Forming label	1560	17,31	0,29
23	RR	Pinning formed labels	1560	17,31	0,29
24	RR	Assembling the kit products	900	30,00	0,50
25	RR	Putting product in the plastic bag and the closure	1500	18,00	0,30
26	RR	Sticking bar code	4000	6,75	0,11
27	RR	Putting the product in a box	7000	3,86	0,06
Total time					2,17

**Picture 2. Operacion technologically sheet**

**Recapitulation:**

Total production time: 15,83minuta

**3.2. Model 2. T-shirt for boys**



**Picture 3. T-shirt for boys**

Based on the needs of investors and the analysis of the technological process of manufacturing shirts for boys, as well as market conditions, adopted the technology product line for boys. Production of 1,900 pieces per shift is optimal

**Model description:**

It consists of 6 parts cutting. The long sleeves, oval neckline. Hem along the bottom width of 2 cm. Render at the bottom of the sleeve. Printed on the front.

*Table 3. Cutting parts*

The main and auxiliary materials	Number of pieces in pattern picture
Front piece	1
Back piece	1
Render sleeve	2
Sleeve	2

Forma VS Belgrade		Operacion technologically sheet - Art 2010 Model name: T-shirt for boys			
Article - 2010		<b>Model description:</b> It consists of 6 parts cutting. The long sleeves, oval neckline. Hem along the bottom width of 2 cm. Render at the bottom of the sleeve. Printed on the front.			Size: 68, 74 ,80 , 86, 92
Op. number	The means of work	Operation name	Norm (piece/450 min)	Operation number (seo/piece)	Production time (min/piece)
<b>Cutting</b>					
1	PR	Manually laying a material on the pattern layer	1800	15,00	0,25
2	RR	Setting pattern picture on pattern layer	2700	10	0,16
3	PA	Rough cutting	46000	0,6	0,01
4	Bansek	Fine cutting	900	30	0,5
5	RR	Packing of cut pieces	818	33	0,55
				Total time	1,47
<b>Silk screen</b>					
1	RR	Printing on the front	900	30	0,5
<b>Sewing room</b>					
1	TP	Bonding the size number	2400	11,25	0,19
2	OV	Sewing right shoulder stitch	2000	13,50	0,23
3	IBO	Sewing ribbon on shoulders, back and front part	3300	8,18	0,14
3a	RR	Separating pieces from the chain	3000	9,00	0,15
4	SNAPS	Putting snaps on shoulder	1800	15,00	0,25
5	OM	Preparation of the shoulder stitch with snap	650	41,45	0,69
6	IBO	Sewing ribbon in the neckline	2200	12,27	0,20
6a	RR	Separating pieces from the chain	3000	9,00	0,15
7	RINGL	Fastening in the neckline	1400	19,29	0,32
8	OM	Sewing renders sleeve	1000	27,00	0,45
9	OM	Sewing renders length	1300	20,77	0,35
10	OV	Sewing the sleeves	700	38,57	0,64
11	OV	Sewing and inserting lables	700	38,57	0,90
12	OV	Preparation render for sleeves	500	54,00	0,45
13	OV	Sewing length	1000	27,00	0,87
				Total time	5,75
<b>Finishing</b>					
14	PP	Pressing T-shirts	900	30,00	0,50
15	RR	Bonding declaration	4000	6,75	0,11
16	RR	Forming label	1560	17,31	0,29
17	RR	Pinning formed labels	1560	17,31	0,29
18	RR	Assembling the kit products	900	30,00	0,50
19	RR	Putting product in the plastic bag and the closure	1500	18,00	0,30
20	RR	Sticking bar code	4000	6,75	0,11
21	RR	Putting the product in a box	7000	3,86	0,06
				Total time	2,17

**Picture 4. Operacion technologically sheet**

**Recapitulation:**

Total production time: 9,9 minuta

### 3.3. Model 3. Bodysuit for boys



**Picture 5. Bodysuit for boys**

Based on the needs of investors and the analysis of the technological process of manufacturing the cloth, as well as market conditions, the technological line of baby products has been adopted. Production of 1,800 pieces per shift is optimal.

#### **Model description:**

Bodysuit are with long sleeves, fronts cut at the shoulders. Render at the bottom of the sleeves, piping on the neckline and around the legs. Printed on the front.

*Table 4. Cutting parts*

The main and auxiliary materials	Number of pieces in pattern picture
Front piece	1
Back piece	1
Render sleeve	2
Sleeve	2
The shoulder parts	2



Forma VS Belgrade		Operacion technologically sheet - Art 1909 Model name: Bodysuit for boys			
Article - 1909		<b>Model description:</b> Bodysuit with long sleeves, fronts cut at the shoulders. Render at the bottom of the sleeves, piping on the neckline and around the legs. Printed on the front.			Size: 62, 68, 74 , 80 ,86, 92
Op. number	The means of work	Operation name	Norm (piece/450 min)	Operation number (seo/piece)	Production time (min/piece)
<b>Cutting</b>					
1	PR	Manually laying a material on the pattern layer	1800	15,00	0,25
2	RR	Setting pattern picture on pattern layer	2700	10	0,16
3	PA	Rough cutting	46000	0,6	0,01
4	Bansek	Fine cutting	900	30	0,5
5	RR	Packing of cut pieces	818	33	0,55
				Total time	1,47
<b>Silk screen</b>					
1	RR	Printing on the front	900	30	0,5
<b>Sewing room</b>					
1	TP	Bonding the size number	2400	11,25	0,19
2	OV	Sewing front piece with shoulders stitches	1200	22,50	0,38
3	OM	Sergering both part	1500	18,00	0,30
4	OV	Sewing right shoulder stitch	2000	13,50	0,23
5	IBO	Sewing ribbon in the neckline	2200	12,27	0,20
6	IBO	Sewing ribbon on shoulders, back and front part	3300	8,18	0,14
6a	RR	Separating pieces from the chain	3000	9,00	0,15
7	SNAP	Putting snaps on shoulder	1800	15,00	0,25
8	OM	Sewing renders sleeve	650	41,54	0,69
9	OV	Sewing the sleeves	700	38,57	0,64
10	OV	Sewing side stitch	1600	16,88	0,28
11	IBO	Sewing ribbon to length	2000	13,50	0,23
12	RR	Separating pieces from the chain	3000	9,00	0,15
12s	OV	Sewing another side stitch with inserting lables	1300	20,77	0,35
13	RINGL	Fastening in the length	2000	13,50	0,23
14	SNAP	Putting snaps on the length	1800	15,00	0,25
				Total time	5,33
<b>Finishing</b>					
15	PP	Pressing bodysuit	900	30,00	0,50
16	RR	Bonding declaration	4000	6,75	0,11
17	RR	Forming label	1560	17,31	0,29
18	RR	Pinning formed labels	1560	17,31	0,29
19	RR	Assembling the kit products	900	30,00	0,50
20	RR	Putting product in the plastic bag and the closure	1500	18,00	0,30
21	RR	Sticking bar code	4000	6,75	0,11
22	RR	Putting the product in a box	7000	3,86	0,06
				Total time	2,17

**Picture 6. Operacion technologically sheet**

**Recapitulation:**

Total production time: 9,35 minuta

## CONCLUSION

The paper explored the technological production line of children's clothing on the principle of "Forma VS". The test is performed on the basis of three models: bodysuit for boys, T-shirt for boys and sweatshirt for girls. We found out the time needed to create each model individually. Model 1 time is 15, 83 minutes. Model 2 time is 9.9 minutes. Model 3 time is 9.35 minutes. Most of time it takes to sweatshirt for girls 83 minutes, and at least for T-shirt for boys, because boys shirt has a minimum phase as regards sewing and quick process in the tailor shop and finishing.

## REFERENCES

- [1] Tehničke informacije preduzeća "FormaVS", 2018
- [2] S.Šunjka, *Analiza i projektovanje tekstilnih procesa*, TF "Mihajlo Pupin" Zrenjanin, 2004
- [3] V. Petrović: European Textile Platform for the Future of clothing and Textile, Regional Textile conference "Sustainable development of the Textile Industry in Republic of Macedonia", Ministry of Economy of Republic of Macedonia in cooperation with Faculty of Technology and Metallurgy, University "Ss. Cyril and Methodius", 04 - 05 October, 2012., Skopje, Macedonia, (*rad objavljen u Zborniku radova u elektronskoj formi*).
- [4] V. M. Petrović: (2006), *Savremene tehnologije u odevnoj industriji*, II Naučno-stručni skup Tekstilne industrije Zapadne Srbije, Regionalna privredna komora Užice, 21-23. septembar 2006.godine, Ivanjica
- [5] V. Petrović, J.Stepanović, M.Stanković, M. Reljić, S.Stefanović: *Savremena kretanja u tekstilnoj i odevnoj industriji u Evropi*, Menadžment, Inovacije, Razvoj, Volume 8, No.1, str. 83 - 89, (2013). UDK005, ISSN 1452-8800.

## TESTING OF STRENGTH OF SEAMS ON UNIFORMS

**D. Joksimović, V. Petrović, A. Milosavljević, S. Sindelić**

Technical Faculty "Mihajlo Pupin", Zrenjanin,

Đure Đakovića bb, 23000 Zrenjanin

**Faculty of Technology Leskovac, University of Nis - The scholarship holder of the Ministry**

email: [danka.joksimovic21@gmail.com](mailto:danka.joksimovic21@gmail.com)

### ABSTRACT

*Some characteristics of seams on uniforms such as strength and elasticity can contribute and make clothing item better and higher quality. For getting wanted quality it is necessary to test the impact of characteristics of seams with fabric structure. During testing the accent was on examination of strength and elongation of seams on two layers of fabric in direction of warp and weft using the same type of stitch. The testing was done with 3 different types of seams: seam without decoration stitch, seam with + 1cm decoration stich and seam with + 1mm decoration stich. For the results of when is the breaking point of the seam under certain force and braking lengthening of tested samples under static force it was used universal dynamometer Tenso Lab3 2512A – Italian producer Mesdan by standard ASTM D 1683.*

**Keywords:** seam, strength of elongation, structure of fabric, warp and weft

### INTRODUCTION

Visual and functional requirements of clothes usually depend of performance characteristics. Visual requirements are based on forms, design, colours, trends and additional equipment. Functional requirements are more related to the durability of clothing use. The seam improves the usability and durability of the functional performance of textile materials that one is sewing together. [1]. Characteristics of right made seam are: strength, elasticity, durability, security and impression. Characteristics of the suitably designed seam are: strength, elasticity, durability, safety and its looks. These characteristics must be balanced with the properties of sewing material in order to form optimal seams that will increase the quality of the garment [2]. The functional and aesthetic performance of clothing products in terms of durability and stability also contribute to the value of the seam strength. [1]. "The size of the seam is an important factor in determining the durability of clothing" [3]. Breaking strength and seam properties are key indicators to ensure that clothing is suitable or not for use [3]. The strength and stretch ability of sewing garments depend on a number of technical and technological parameters, such as: the type of fabric, the type and fineness of thread, the fineness of sewing needle, the seam type, the type of sewing stich, density of sewing stitches, tightening of the sewing thread when sewing stitches etc. [4]

### MATERIAL AND METHOD

The experimental part shows the test of seam strength. For fabrication of samples for testing, a fabric of polyester blend 89.95% / cotton 10.05% and polyester thread 100% for sewing samples. Parts of fabric samples were coupled in a test tube using of stich 301.

For this testing method of interrupting force and interrupting of the seamed seam, we use samples of fabric 70 mm in width and 150 mm in height (Picture 1). Two or more fabric samples are positioned one above the other faced “front side of fabric to front side of fabric” or in some other order, and then we sew them together with adequate machine. We get the final shape of the sample when we cut the closing edges of the fabric close to seam.

When we do this we have to take care that seam doesn't get damaged and that the length of the seam remains 50mm. After that, the thread that remained on the edge of the fabric near the seam should be sealed up to the fabric so that the seam doesn't rip. Before testing the sample, it is necessary to mark a line indicating the exact distance of the seam to the clamp of the dynamometer in order to obtain the most accurate results. Distance from the seam line is 100mm.

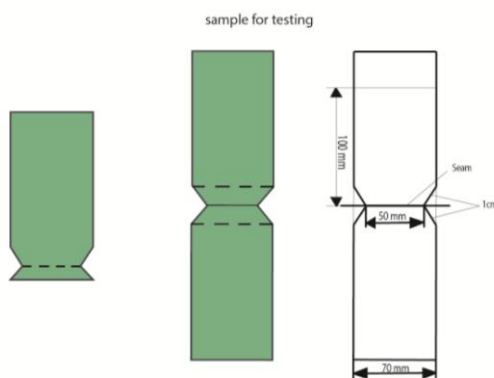

*Figure 1: Schematic representation of the preparation of samples for testing the strength of stitched seam*

The universal dynamometer Tenso Lab3 2512A - the Italian manufacturer Mesdan method according to the ASTM D 1683 standard was used for measuring interrupted force and interruption of elongation of the tested samples under the influence of static forces.



*Figure 2: Testing of samples on a dynamometer; shot with camera*

## **RESULTS AND DISCUSSION**

In addition to the obtained computer diagrams, the computer provides comparative numeric values for all points (not just a breakpoint) of force-elongation. These numerous values can be used for drawings of different diagrams using Microsoft Excel, by entering each acquired number of the expanding and decreasing stretch strength that can be used for analysing and making different diagrams.

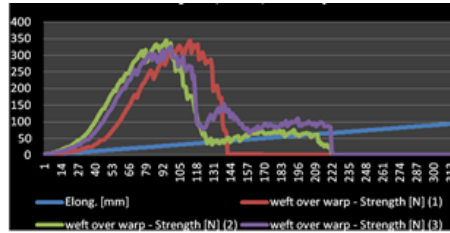

Diagram 1: Seam 1

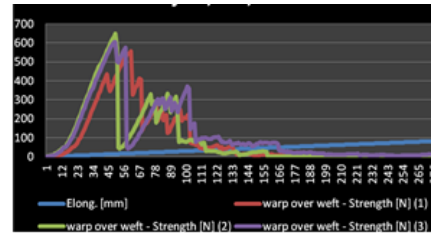

Diagram 2: Seam 2

Comparison of two seams – two fabrics in seam, stitch type 512; 301

Tabel3

Number of fabrics in seam	Numeric number of seam sample	Direction	Stich type	Decoratio n stich	Tear seam strength [N]	Elongation [mm]
<b>2 fabrics</b>	Seam 1	Weft	512;301	-	336	30,2
	Seam2	Warp	512;301	-	<b>578</b>	<b>15,9</b>

In Table 3 it is shown that the tear strength at seam 3 is 336 N, the elongation is 30, 2 mm, while the tear strength at seam 10 is 578 N with elongation of 15, 9 mm. The results indicate that there is higher seam strength and less elongation at the seam 10 - from the warp.

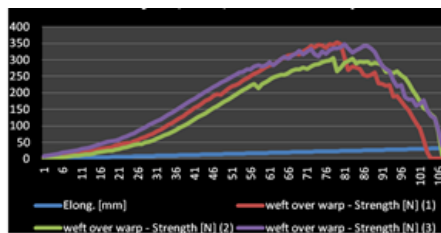

Diagram 3: Seam3

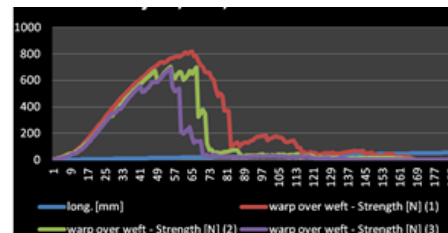

Diagram 4: Seam 4

2. Comparison of two seams – two fabrics in seam, stitch type 512; 301 + 1cm

Tabel4

Number of fabrics in seam	Numeric number of seam sample	Direction	Stich type	Decoratio n stich	Tear seam strength [N]	Elongation [mm]
<b>2 fabrics</b>	Seam 3	Weft	512;301	1cm	333,66	23,3
	Seam 4	Warp	512;301	1cm	<b>736,33</b>	<b>18,4</b>

In Table 4 it is shown that the tear strength at seam 4 is 333, 66 N, the elongation is 23.3 mm, while the tear strength at seam 2 is 736, 33 N with elongation of 18, 4 mm. The result indicates that the higher tearing strength of the seam and also the smaller elongation is at seam 2- from the warp.

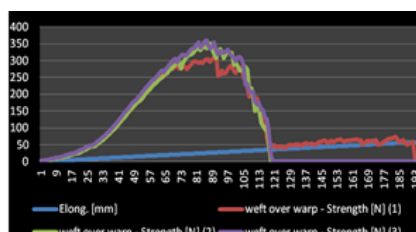

Diagram 5: Seam 5

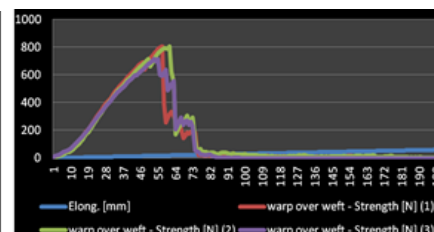

Diagram 6: Seam 6

### 3. Comparison of two samples – 2 fabrics in seam, stich type 512; 301 + 1mm

*Tabel5*

Number of fabrics in seam	Numeric number of seam sample	Direction	Stich type	Decoratio n stich	Tear seam strength [N]	Elongation [mm]
<b>2 fabrics</b>	Seam 5	Weft	512;301	1mm	328,33	27,9
	Seam 6	Warp	512;301	1mm	<b>775,33</b>	<b>17</b>

Table 5 shows that the tear strength at seam 9 is 328.33N; the elongation is 27.9mm, while the tear strength at seam 11 is 775.33N with a 17mm elongation. The results indicate that the higher sewing strength of the seam as well as the less elongation at the seam 11 - from the warp.

Looking in to results, it can be concluded: that in the seams formed by combining two materials which are teared in the direction of the warp have a significantly higher strength than the samples tested in the direction of the weft. The difference in the strength of the seams in the direction of the warp and in the direction of the weft probably comes from the structure of the fabric itself. From Table 1 we can see that the density on the warp of fabric that was used for making samples is twice the density of the weft (45 / 22cm-1). This has also made seam structure: they have higher strength values in the direction of the warp than on the weft.

## CONCLUSION

When sewing, it is necessary that the seam strength is approximate to the strength of the material, in order to have uniformity of the product, which will endure all the forces that the product will be exposed to later in use. During garment wearing the product is challenged to maintain perfect, especially at joints or seams. With different body movements and stretching of different types of fabric requires certain level of elasticity that the seam has to endure. In other words, the durability of the seam is reflected in the relationship between the elasticity of the seam and the fabric, as well as its strength. Designing sewing stitches is a current difficulty in clothing production and requires complex processing of data on used fabrics, seam threads, seams and stiches. [5]

The breaking strength of the fabric and the sheath strength of sheaves directly affect the strength of the garment. The shear strength of shear is the force needed to overcome friction between the threads of the base and the foot. [6]

The paper examined the strength and elongation of the seams of two layers of material in the direction of the wrap and in the direction of the weft. The result of the test is that seams made by combing two materials all the tered samples in the direction of the warp have a greater strength compared to the tested samples in the direction of the weft. The density of the used fabric for making of samples is twice the density of the weft (45 / 22cm-1), which confirms that the structure of the fabric has a significant effect on the strength of the formed seam.

## REFERENCE

- [1].Glock, R.E. and Kunz, G.I. 1995. *Apparel Manufacturing: Sewn Product Analysis*, Englewood Cliffs, New Jersey, Prentice Hall.
- [2].ASTM D6193-09(2009). *Standard practice for stitches and seams*. From <http://www.astm.org/standards/D6193.htm>.
- [3] G.Seetharam, L. Nagarajan,#Evaluation of Sewing Performance of Plain Twill and Satin Fabrics Based on Seam Slippage Seam Strength and Seam Efficiency# IOSR Journal of Polymer and Textile Engineering ( IOSR-JPTE) e – ISSN: 2348-019X, p-ISSN:2348-0181, Volume 1, Issue 3 ( May-Jun.2014), PP 09-21 [www.iosrjournals.org](http://www.iosrjournals.org) .
- [4] A.Kunštek i B. Knez: *Utjecaj tehnoloških faktora na čvrstoću šavova odjeće*, Teksti 35 ( 1986.) 4 str,225-238
- [5] D.B–Popov, V. Petrović, J. Stepanović, M. Reljić: *Utjecaj tkanine i konca na jačinu šavova, naučno-stručni skup Menadžment, inovacije i razvoj*, Vrnjačka Banja, april 2009.
- [6] P., M., Latzke i R. Hesse: *Textilien. Prüfen-Untersuchen- Auswerten*, Fachverlag Schiele und Schon GmbH, Berlin 1974. Str 1148-188

## THE EXPERIENCE OF SUMMER SCHOOL AT DONGHUA UNIVERSITY IN SHANGHAI

**Milica Marjanović, V. Petrović, \*N. Zivlak, D. Joksimović, \*\*A. Milosavljević, S. Sindelić**

Technical Faculty "Mihajlo Pupin", Zrenjanin,  
Đure Đakovića bb, 23000 Zrenjanin

\* Emlyon business school Asia,

**\*\*Faculty of Technology Leskovac, University of Nis - The scholarship holder of the  
Ministry**

Email - mmkastel@hotmail.com

### ABSTRACT

*In this work I will introduce you to my experience on Summer school at Donghua University in Shanghai.*

*This program is hosted by Donghua University since 2014, and students from whole world come to attend there program. The program is 4 weeks long. In that time students learn about Chinese culture, language, tradition, fashion and work on projects in teams. It aims to help the participants gain a profound understanding of Chinese traditional costumes as well as their modern development.*

*Donghua University (DHU) was founded in 1951. It is one of 75 universities that are under the direct management of the Ministry of Education of China, one of the Universities that accepted international students as early as 1954, as well as one of the first batch of 27 universities that have passed the Quality Accreditation for International Students Education. DHU enrolls nearly 4800 international students from nearly 140 countries each year. These population ranks 10th among the universities in China. Students from Technical Faculty "Mihajlo Pupin" in Zrenjanin which is a part of University of Novi Sad get rare opportunity to go on Summer school at Donghua University because of their collaboration agreement with University of Novi Sad. Some faculties whose students are participating in this program are the best ones in there field -fashion and textile design.*

### 1. About Donghua Univesety

Donghua University (DHU), formerly China Textile University, was founded in 1951. Located in the downtown area in Shanghai and adjacent to Hongqiao Economic Development Zone, DHU is one of the state-key universities directly under the Ministry of Education of China. Its feature disciplines, such as Fashion Design, Textile Engineering, International Trade, Material Science, and Information Technology have received high reputation both domestically and abroad.

DHU is a multi-disciplinary university with a wide range of undergraduate and graduate degree programs across a vast field of disciplines including engineering, economics, management, literature and art, laws, science, and education. It has 13 colleges and schools, offering 54 undergraduate programs, 59 master's degree programs, 30 doctoral degree programs, and 5 postdoctoral research programs, among which are 6 state key disciplines and 7 Shanghai municipal key disciplines. Academic achievements have found applications in areas such as aeronautics, military science, new material, architecture, and environment protection. The number of valid patents ranks top 12 among Chinese colleges and universities.

There are more than 2,800 faculty professors and staff, and over 30,000 enrolled students at DHU. The employment rate maintains 100% for post graduates and over 95% for undergraduates in the past several years. So far, DHU has established cooperation with over 100 well-known oversea Universities, research institutions and enterprise. DHU also successfully held international conferences and forums in the fields such as textile, fashion, and material.



As early as 1954, DHU commenced to accept international students who were among the first group of overseas students enrolled by Chinese universities. To date, DHU has brought up a huge number of international students from over 130 countries. Almost all of undergraduate programs, postgraduate and research programs are open to international students.

Besides, non-degree programs including Chinese language programs, Degree-Preparation program, advanced study programs, and a variety of short-term programs are available to international students. The faculty campus except the usual things: faculty offices, classrooms, dorm, library, canteen, coffee shop, supermarket has sport facilities, hotel and Shanghai museum of textile and costume.



*Picture 1: Campus of Donghua University*



*Picture 2: Shanghai museum of textile and costume*

## 2. Shanghai

Shanghai is one of the four municipalities under the direct administration of the central government of China, the largest city in China by population, and the second most populous city proper in the world, with a population of more than 24 million as of 2017. Located in the Yangtze River Delta, it sits on the south edge of the estuary of the Yangtze in the middle portion of the East China coast. The municipality borders the provinces of Jiangsu and Zhejiang to the North, South and West, and is bounded to the East by the East China Sea

Shanghai architecture is rich in different styles, from old ones to real modern architecture. Shanghai has a rich collection of buildings and structures of various architectural styles. The Bund, located by the bank of the Huangpu River, is home to a row of early 20th-century architecture, ranging in style from the neoclassical to the Art Deco. Many areas in the former foreign concessions are also well-preserved, the most notable being the French Concession. Shanghai has one of the world's largest number of Art Deco buildings as a result of the construction boom during the 1920s and 1930s. One of the most famous architects working in Shanghai was László Hudec, a Hungarian-Slovak architect who lived in the city between 1918 and 1947. The Bund's first revitalization started in 1986, with a new promenade which was completed in the mid-1990s.



*Picture 3: The Bund, view over to new part of the city and Shanghai Pearl tower*

### **3. Summer School 2017 Chinese Traditional Costume Program (3S-CTCP)**

The program contains 4 sectors:

**-Lectures that include:**

Chinese traditional costume art, history, comparison between Chinese and western art, Shanghai style fashion trend and innovation, etc.

**-Cultural segment:**

Chinese traditional culture, such as calligraphy or painting, tea ceremony, traditional dress try-on or making, music instruments.

Chinese language:

Mandarin basic course of language knowledge for surviving in Shanghai as well as the apparel contents that were useful and helpful during visits.

**-Practices:**

Assignments consist of in-class preparation on the description and understanding of the assignment and then field investigations and tasks. Field trips to the museums, fashion studio and production with all were guided with professional introduction of professors.

**-Workshop:**

Students from different countries were paired in teams in order to explore to get inspirations, prepare and work together on joint collection.

We had Chinese language classes twice a week for 3 hours and the rest of program was changing each week.

### **4. First week**

Other than mentioned Chinese language classes in first week we were introduced to traditional Chinese music and different instruments they use to make that music. We had a class about Chinese culture and later the same day the same teacher took us to Shanghai museum where we saw a rich collection of traditional paintings, costumes, various jade items, coins from different eras and famous Ming period china.

Next day we had class called: Cultural Symbols Constitute Postmodernist Fashion Identity, the same day the same teacher took us to fashion production near the city. That apparel company produces mostly men's jackets and coats in finest fabrics, modern design and high quality.

On Friday, the last work day of week we had class about important meter: how to find suppliers in the fashion industry and after that we went of a fieldtrip on suppliers market where we were divided in groups and like that visited market and looked for suppliers for our imagined product.

Weekends were always free so we could do what we liked, visit city attractions, museums, and whatever we were interested in to do.

## 5. Second week

In week two we were introduced to history of Chinese costume and textile, and we visited Qipao boutique, which is a boutique of modernized luxury traditional Chinese dresses, a Chinese version of Haute couture. Those dresses have hand embroidery, they are mostly made of silken fabric and each and every is unique and little work of art. In Qipao boutique we had an honor to get a special lecture from boutiques designers and some of us were picked to try on some of the dresses.



*Picture 4: Whole class of 2017.with designers of Qipao boutique*

In second week we were divided in to 5 groups for our team assignments and got the instructions what we should do until next consultations which were next week. Each team got one domestic Chinese student to help and work with team.

The rest of classes in second week other than Chinese classes were: tea ceremony demonstration, Shanghai style fashion trends & innovation and luxury brand management in China with the fieldtrip to luxury brand shopping mall to do the mystery shopper assignment where we rated the shop and its stuff by 5 different categories.



*Picture 4: From tea ceremony where we tried making few kind of teas in traditional way*

## 6. Third week

In third week after the consultations about team assignments we had one day free so we can devote time and energy to our assignments. My team picked as inspiration the diversity and differences in Shanghai architecture. We had workshop of hand making miniature traditional Chinese costume. We were divided in 3 groups and each group did different costume.



*Picture 5: one of the groups with their finished dresses*

In the end of third week we had two day trip to Hangzhou also called Haven city. During the trip we visited Textile Library witch is unique in the world and the largest Silk museum in the World.

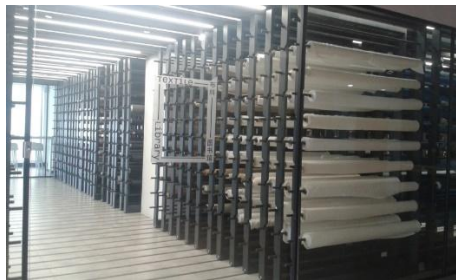

*Pictures 6 and 7: Textile library*



*Picture 8: Silk museum*

## 7. Fort week

In last week we had one on one Chinese language test with teacher. We had Chinese painting class as well to relax from last week stress.

In last day of program we had presentations of each team. We showed results of our work on collections.



*Picture 9: Me while presenting part of my teams work*

## 8. CONCLUSION

During the program on Donghua University besides learning about Chinese culture and tradition we had opportunity to meet people from different countries and fashion faculties, hear about their education system, points of view and perspective.

We learned about fashion industry in China which is one of the most powerful countries in area of production. The program is really well thought and leads you through all segments of fashion. After program you really can say you went through all elements of fashion industry. We got to know that even though China is more of a supplier country they want to become a design country as well.

China is also one of the biggest markets when it comes to luxury brands.

All in all it was an exquisite experience and unique opportunity to hear and learn about these things from their experts in the source.

## 9. LITERATURE

- [1] <http://english.dhu.edu.cn/main.htm>
- [2] <http://dhumandarin.ices.cn/fashion>
- [3] <https://www.wikipedia.org/>
- [4] [www.google.com](http://www.google.com)
- [5] Bartels, V. (ed.) (2011) Handbook of medical textiles. Elsevier
- [6] Bruer, S. M. and Smith, G. (2005) 'Three-Dimensionally Knit Spacer Fabrics: A Review of Production Techniques and Applications', Journal of Textile and Apparel Technology and Management
- [7] Davies, A. and Williams, J. (2009) 'The use of spacer fabrics for absorbent medical applications', Journal of Fiber Bioengineering and Information

## ANALYSIS OF INTERFACE CHARACTERISTICS OF SIDE SEAM ON THE CLOTHING

Anita Milosavljević, D. Trajković, N. Ćirković, J. Stepanović

\*Faculty of Technology Leskovac, University of Nis - The scholarship holder of the Ministry

\*Technical Faculty "Mihajlo Pupin", Zrenjanin,  
Đure Đakovića bb, 23000 Zrenjanin  
mail: [anita.milosavljevic@hotmail.com](mailto:anita.milosavljevic@hotmail.com)

### ABSTRACT

*This work analyzes the trousers of the Belissima Company, which sewed the sewing problem. All trousers with all the technological parameters of manufacture were observed. Then they were named for analysis of chain points by using different needle numbers and longitudinal masses of threads. The aim of the work is to investigate which long end of the needle and the needle track will lead us to the strongest seams and the best seams for the trousers, in which trousers the users will feel best without breaking the seams when using the trousers. In order to achieve the most reliable results and improvements in the quality of seams and the product itself, realistic samples that are in the regular production of trousers that were analyzed were tested. Two types of materials were examined, which contained elastin and elastomer material, for the strength of the seams of the side pants on the base.*

**Keywords:** Seams, needle pins, longitudinal mass, thread, seam strength.

### 1. INTRODUCTION

When sewing clothes, in the ready-to-wear industry, seams have a great significance in joining sparkling parts of garments. In the process of garment production, there are numerous parameters that affect the quality of seams. These are, among other things, the type of material, fineness of threads, types of sewing points and their density. In order to obtain very attractive clothes, which satisfy the comfort of wearing and the possibility of unobstructed movement of the body and its parts, then a nice "drop" of clothes and easy maintenance, the fabric manufacturers have produced a wide range of elastic fabrics from a variety of yarns. The appropriate point type must also be determined, the optimum sticking density, the shape of the tip of the needle, the best way of transporting the sewing material, the needle speed, and more.

### 2. TESTING MECHANICAL CHARACTERISTIC OF SEAMS

The strength and stretchability of sewing garments depends on a number of technical and technological parameters such as: the type of fabric, the type and fineness of the sewing thread, the sewing fineness, the type of seam, the sewing type, the sewing density, the tightening of the sewing thread when sewing the sewing designs. The breaking strength of the fabric and the sheath strength of sheaves directly affect the strength of the garment. The shear strength of shear is the force needed to overcome friction between the threads of the base and the foot

Mechanical properties of textile materials are aimed at determining the strength by tensile force, pressure, bending, twisting, deformation in the action of force, etc. The strength represents the resistance to completely breaking the links between the particles of the material, while the deformation is due to stress. In this case, elastic and plastic segments of deformation are especially important for textile materials.

### 3. EXPERIMENTAL PART

The Belissima trousers were analyzed and the sewing problem appeared. All trousers with all the technological parameters of manufacture were observed. Then they were named for analysis of chain points by using different needle numbers and longitudinal masses of threads.

The aim of the paper is to investigate which long end of the needle and the needle track will lead us to the strongest seams and the best seams for the trousers, which trousers the users will feel best without breaking the seams when using the trousers. In order to achieve the most reliable results and improvements in the quality of seams and the product itself, realistic samples that are in the regular production of trousers that were analyzed were tested. Two types of materials were examined, which contained elastin and elastomer material, for the strength of the seams of the side pants on the base.



*Picture 1. Belissima model pants*

### 4. CHARACTERISTICS OF THE MATERIAL BEING TESTED

Two types of fabrics were selected for the fabrication of the seams for testing. Material I was made of a mixture of polyester and cotton (67:33), while material II was made of cotton with 3% elastane (97:3). These materials are normally used in regular production at the Belissima Company, but there is more elastane material.

The samples were prepared and the quality of sewing pants, which are part of the Belissima production program, were tested, but no additional materials were examined, but only the quality of the seams, in the grain and chain points and the longitudinal mass of the end. Picture 2. shows the used fabric for making samples.

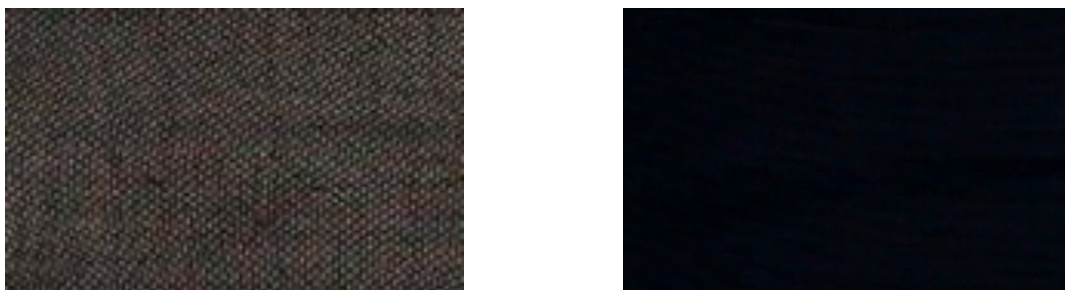

*Picture 2: Display of used fabrics from which sewing patterns are tested*

## 5. CHARACTERISTICS OF THE THREAD USED FOR TESTING

Table 1: Values of the examined end I - longitudinal thread Tex 10

QUALITY CONTROL		
serial number	Rated quality characteristic (unit of measure)	Value obtained
1.	Raw material composition (%) POLYESTER	100
2.	Determination of longitudinal mass (tex)	20 (10x2)

Table 2: Values of examined end II - length end of thread Tex 8

QUALITY CONTROL		
serial number	Rated quality characteristic (unit of measure)	
1.	Raw material composition (%) POLYESTER	100
2.	Determination of longitudinal mass (tex)	16 8x2)

## 6. PREPARATION OF TEST SAMPLES

For the method of intermittent and intermittent elongation of seam welding, samples of fabric 70 mm in width and 150 mm in height are required. Two or more samples are placed one above the other face on the face or in some other order and then passed through the appropriate machine. The final shape of the sample is obtained when the closing edge of the fabric is close to the seam, ensuring that the seam is not damaged so that the length of the seam remains 50 mm. After that, the thread that remained on the edge of the fabric near the seam should be adhered to the fabric so that the seam will not be paired. Prior to testing the sample, it is necessary to mark a line indicating the exact distance of the seam to the clamp of the dynamometer in order to obtain the most accurate results. The distance from the stitch line is 100 mm. The samples were stitched with needles of the numbers 80 and 90. The sewing thread of the longitudinal mass 20 tex and 16 tex was used for sewing the samples required for interrupting the seams. Some fabrics are welded with stitching type 1.01.03 and type 301. The point density applied was 4 cm-1. The samples were prepared in such a way that the seams were sewn in the direction of the base and in the direction of the stream. Thus, the seams samples represented the real seams used to make pants that were analyzed. The strength of the seam on the side of the trouser pantalone was examined both on the basis and on the course. Seamed chain stitches were examined. In doing so, he wanted to investigate which is the number of needles and the length of the end of the end is better.

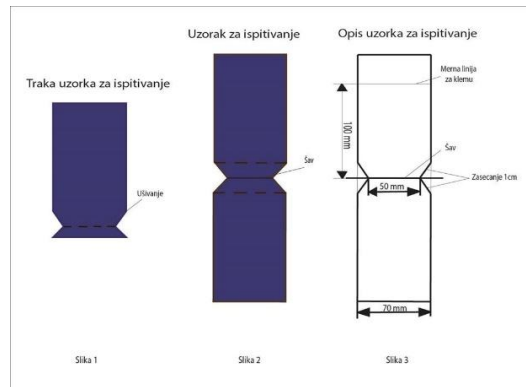

Picture 3: A schematic representation of the sample preparation for testing the strength of sewing the seam



## 7. MACHINES AND DEVICES FOR THE FABRICATION AND TESTING OF SEAM SAMPLES

### 8.

The machines and devices used for the preparation and testing of samples are:

- ❖ ❖ Juki's fast-moving machine
- ❖ ❖ Siruba's conventional high speed machine
- ❖ ❖ Dinamometer Mesdan S.p.A - Tenso Lab

The technical specifications of the machine are:

- stabs - grain sticks type 301- maximum length of the stem 5mm
- lower and upper transport
- Raising the stomach up to 13mm
- automatic cutting of the end
- sewing machine speed - 4,500 ppm \*



*Picture 4: Usual sewing machine Juki - joining samples*



*Picture 5: Common Siruba sewing machine – stitching*

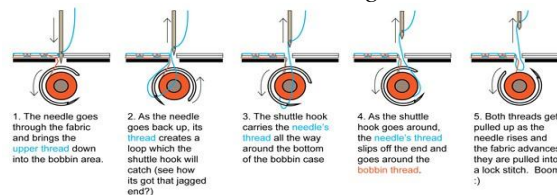

*Picture 6: Formation of machine stitches type 301*

## 9. RESULTS OF THE EXAMINATION

In order to achieve a more reliable overview of the current state of strength and quality of the seams after breaking all the seams on the dynamometer, an analysis of the obtained results is obtained. Three samples were made for each seam. The individual tearing of these samples was done, and the results were processed and the mean values of the individual measurements of the same type of samples were given. In this way, we wanted to come up with recommendations for getting quality and durable sewing garments that the company manufactures, that is, for the model used for stitching.

The mean values of breakdown and interrupted elongation are given below.

### 9.1. Material I - display and compare results on histograms

In the continuation of the work on the histograms, the mean values of samples I and material II are shown. The highest sewing strengths are shown when changing the needle number 80 and 90 to the longitudinal weight of the end 20 tex and 16 tex, as well as the greatest elongation occurring during these changes on the base and the sewing using the chain stitch.

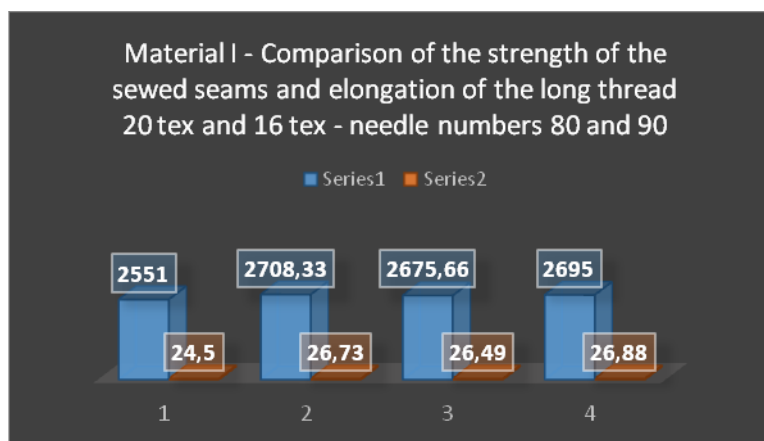

*Picture 7.*

In picture 7, intermittent strength and elongation of the seams of the sewn end-lengths of the end of 20 tex and 16 tex were shown based on the needle numbers 80 and 90 for both longitudinal ends of the end on the first test material.

The results shown on these histograms show that the needle number 90 when applying the end of the longitudinal weight 20 tex in the direction of the base and the chain point, has resulted in the obtaining of an extra strong seam strength. The seam strength is 2708.33N, and the elongation of the seam is 26.73mm. This proved to be the best combination of the applied needle number and the long end of the end to obtain quality seams.

The reduction in seam strength occurred when using the needle number 80. The reason for this is the inadequate number of needles. This has led to damage to the material and getting the seams of the least strength and elongation, the strength is 2551N and the elongation is 24.5mm.

## 9.2. Material II - display and compare histogram results

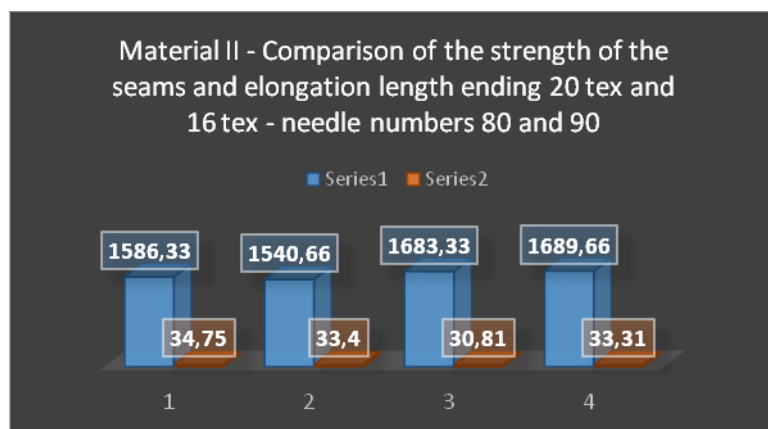

*Picture 8.*

Picture 8 shows the breaking strength and elongation of the seams of the sewn lengthwise ends of the thread of 20 tex and 16 tex based on the needles of the needles 80 and 90 for both longitudinal ends of the end of the second test material.

The results shown on these histograms show that the application of the end of the longitudinal weight 20 tex in the direction of the base and the chain point gave an excellent seam strength of 1689.66 N and the achieved elongation of the seam is 33.31 mm. The greater elongation from this is obtained by applying a needle number of 90 and it is 34.75mm. With this combination of needle pins and long thread lengths, the seam and quality of the garment can be improved.

The results show that the combination of the chain point and the application of the needle number 90 leads to obtaining the seams with the greatest elongation and good quality.

The consequences of damage to the seams can be seen from the degree of disruption of their construction. Damage is visible when the sewing bursts occur, due to the sealing of the connecting points of the material crosswise to the seam and simultaneous stretching of the sewing thread, shearing the threads of the fabric in the area of the sewing burst, which is caused by the sewing of a sewing thread, fabric or bursting of the seam itself.

By comparing the results with the material I, the seam made in the direction of the base, the chain bar, the longitudinal weight of the end of 20 tex and the needle of the track 90 proved to be the most robust.

This good result produces a combination of high-quality ends, that is, the end of the medium longitudinal mass is applied. Also, the corresponding needle number for this longitudinal mass of the end has also been applied. In this case, the needle does not make a large damage on the material, and the seam is thus stronger and durable, which is why it can be recommended for use.

## 10. CONCLUSION

According to the results obtained, it can be more precisely to conclude where the load causes damage and cracking of the seams on the pants as well as what are the causes of it. Looking at the total results obtained in this paper, the application of the end of the larger longitudinal mass and the chain bar on the elastin material gives the greatest breaking strengths and interruptions of the seams. The results obtained in this paper show this. The chain point has a high elasticity, making the seams more durable in the direction of the base and in the direction of the stream when combined with the corresponding longitudinal end of the end and the needle number.

The proposal for the examined pants model is to work with elastane fabrics, chain sticks, but with a larger length ending end with changing and adjusting needle track. This is indicated by better results achieved by testing.

This is the obtained seam on the elastane fabric (the longitudinal mass of the end 20 tex used, and the used needle number 90), where the interrupted elongation of 34.75 mm was achieved. This seam has a satisfactory breaking strength and high elasticity compared to the same stitched chain stitch on a material without elastane.

The results of this paper have shown that the quality of the seam can be improved using a chain stitch, using fabrics with elastane and changing combinations of needle tracks and longitudinal masses of threads.

## 11. LITERATURE

- [1] A. Kunštek, B. Knez: Damage to seams on clothing, *Tekstil - Zagreb*, 35 (1986) 6, 389-402
- [2] U. Schmid, J. Mecheels: Kräfte an Textilien und Nähte der Kleidung in  
i. Abhängigkeit von Körperbewegungen und Kleidungsschnitt, *Bekleidung + Wäsche*, 33 (1981) 2, 77-82
- [3] В. Ф. Шаньгина: Структурная схема показателей качества соединений деталей одежды, *Технология легкой промышленности - Москва*, 26 (1983) 2, 113-117
- [4] Е. Б. Коблякова: Структурная схема показателей определяющих уровень качества одежды, *Швейная промышленность - Москва*, (1976) 2, 10-11, (1976) 3, 21-24
- [5] D. Rogale. D. Ujević, S. F. Rogale. M. Hrastinski: Processes of clothing production, Zagreb, Faculty of Textile Technology, University of Zagreb, 2011

## TECHNOLOGY FOR THE MANUFACTURE OF CAP (TULJAK)

**D. Joksimović, V. Petrović, A. Milosavljević, S. Sindelić**

Technical Faculty "Mihajlo Pupin", Zrenjanin,

Đure Đakovića bb, 23000 Zrenjanin

**Faculty of Technology Leskovac, University of Nis - The scholarship holder of the Ministry**

email: [danka.joksimovic21@gmail.com](mailto:danka.joksimovic21@gmail.com)

### ABSTRACT

*The paper describes the technology of making of the hat by "Begej hat" brand on the example of "Capital Group". The production of the hats was made with a felting technique. The technique is very demanding, which is confirmed with the fact that is still being perfected today. The paper describes picking and felting operations as the two most important techniques for producing caps and hats.*

**Keywords:** hat, wool, picking, felting

### INTRODUCTION

The production plant is located in the township of Ruma and it consists of production and warehouse space and the office space. The factory is equipped with modern machines for production of caps, which make up the basic production program of the factory. Production of caps and hats is unique in Serbia and in the surrounding area, while in Europe there is only in the Czech Republic, Poland and Portugal, so Capital Group is the fourth largest factory in Europe. Production is based on the tradition of the factory "Begej" from Zrenjanin, and it was upgraded with new machines and new technology of coloring and processing of wool. This type of production is significant not only due to market placement (distribution in the region, countries of the former SFRY, buyers in Italy, France, Austria, Germany ...), but also because it initiates the development of domestic livestock breeding, because the basic raw material that is used is natural wool. [1]

Begej woolen felt hats for today's hats, Capital Group produces with tradition, with the experience and knowledge of long-time workers, innovations from young management personnel and permanent technological development. Ready to respond to standard or specific requirements to satisfy a wide range of customers. The Begej woolen felt cap is made from high quality wool from South Africa and from Australia for making the finest woolen hats. [2]

### MEASUREMENT OF WOOL AND PREPARATION FOR PICKING

The wool in the company arrives in bales packed in nylon. According to the regulations in the textile industry, the wool is classified according to color and quality, which differ according to the origin of the wool. The natural color of the wool can be white to yellowish - which is most often represented on the market and dark to black - rarely represented and less demanded.

In warehouses, except for the classification of wool by color and quality, we also measure the mass of wool in certain quantities. Measurements of wool mass are carried out in quantities of 20kg, which in the textile industry are called "batches" of wool.

The most commonly measured is five wool lots, totaling 100kg. The wool batch represents a certain amount of wool that can be used in the process of production of hats from 20 and 50 kg all depending on which part of the process is taking place.

Measurements of the mass of wool in certain batches are carried out in a warehouse in which the wool is pre-stored. The specific quantity of wool weighed depends on the customer's order and is called the wool batch. The weight of the batch to be used depends on the order of the buyer.

**Example 1:**

If the batch order quantity is 50kg, the wool batch has the following proportions:

wool 40%	20kg
kemling 60%	30kg

**Example 2:**

If the batch order quantity is 50kg, the wool batch has the following proportions:

wool 40%	20kg
kemling 50%	27kg
waste wool 10%	3kg

Waste wool is used as a substitute for kemling. Depending on the extra percentage of waste wool, the percentage of kemling is reduced. Example: If the standard wool is 40%, kemling 60%, in the event that waste wool is added 10%; The percentage of kemling is reduced by 10%.



*Picture 1: Measured mass of the wool batch*



*Picture 2: Display of the waste wool under the picking machine*

The mixing and after-opening operation with greasing belongs to a very important part of the preparation process, since it aims to finalize fiber preparation so that it can be processed without interruption in further processing. The third phase operation is performed with the appropriate pre-mix preparation.

Preparation of the mixture refers to the pre-making of the "beds" of the mixture, and then by passing this mixture on the "wolf picker", in order to achieve the best possible mixing of the fibers. Creating a "bed" is done near the "wolf picker" to make the transfer of the finished "beds" easier, and therefore the productivity of the work is higher.

The number of layers of fiber strands depends on the desired color of the "bed". The first layer of fiber strands is an average thickness of 10cm.

Upon completion of the first layer, a pre-prepared emulsion is applied to the upper surface by means of a mechanical sprayer. Thereafter, a second layer of fiber strands is applied, followed by an emulsion layer, the process is alternating depending on the number of layers.

**Example 1: White "bed"**

By mixing fiber strands, the possibility of mixing in the form of different colors and raw materials quality of fibers compositions is obtained, taking into account the percentage participation of different colors or the same colors of different shades. When making such a mixture, it is necessary to take care of the correct mixing. By mixing two or more colors of the strands, the melange occurs.

### Example 2: Melange "bed"

By making **melange** "beds", the minimum number of layers is five to six in a similar arrangement.

1. water
2. oil with an antistatic property

The oil is very important in making emulsions, and it is necessary to take into account its basic characteristics, such as:

1. Water wash (preventing fiber greasing in the process of painting).
- 2 appropriate viscosity
3. Good lubrication capability

The ratio of water and oil depends on the weight of the bed, the room temperature and the weather conditions. If the weather is colder it is needed a smaller amount of water and vice versa.

**Example:** For a mass of beds of 50kg the size is as follows: ½ l of oil  
8 - 10l of water

The opening of the fibers is carried out on the so-called the "wolf picker" machine where the worker simultaneously manually takes a certain amount of "beds", puts it on the input conveyor where the entrance strands are accepted by the working organs of the picking machine who are tasked with carrying out the bulk strand fibers and then taken over by the pneumatic pipeline directing them directly into a certain room (chamber). The chamber is a metal structure, with a height of 2 -3 m connected to the picker machine.

The wolf picker, similar to the picker, has a drum with several working units for opening and mixing the fibers. The working unit consists of a pair of working rollers - a portable roller, whereby in the direction of material movement, a portable roller is placed behind the working roller, which ensures that the fibers pass through one single point only once (as opposed to the picker), which reduces the intensity of opening and preventing fiber damage . [3]



*Picture 3,4: Display from wolf picker*

Picking of wool is done on the machines "pickers". On elements such as: main drum, working and moving rollers, volant and penyer, there are certain needle sets as surface linings that serve to accept beam of fibers, separate the individual fibers and paralelize the fibers, as well as to direct the fibers to the exit from the picker machine and the joint them in a unique compilation.



Picture 5



Picture 6



Picture 7

Picture 5: Display of picker machine

Picture 6: Enlarged display of the feeding rollers

Picture 7: Enlarged display of winding the flori on the roller mechanism

### PICKING THE WOOL ON THE CONUS - PICKING MACHINES

After the wool picking process has been completed on the "picker" machine flori is transmitted to a machine called the "conus-picker", in which the picking process is repeated in a certain way. The picking of the flori is used to mix the "web" from the yarn with the flori, better parallelization of the flori, as well as the formation of a new unique fleece of interconnected fibers and "webs". The conus - picking machine consists of the following elements:

1. the feeding rollers
2. work desk
3. main drum
4. a system of worki and moving rollers, located on the upper half of the main drum.  
The number of these so-called working points ranges from 3 to 8.
5. quick roller, volant
6. roller for removing, penyer
7. comb for removing the flori
8. cone roller system. It consists of 4 cross-linked metal conical rollers and one wooden one located on them.
- 9.



Picture 8: Appearance of a conus-picking machine



Picture 9: Enlarged appearance of the conus-roller

Flori that was previously formed on a picker, is invested in a workstation "conus - picker" along with "web" of yarn. The workstation further transmits them to the feeding rollers, whose task is to correct the speed of delivery of the flori and "web" and their transfer to the system of working and portable rollers of the main drum. It accepts the flori together with the "web" and mixes them, and the better parallelization of the flori fibers, as well as the roller and the device for removing the flori (gramba) to the cone roller system.



Flor is accepted by a worker who uses the machine "cone - picker", winding on a wooden cone - roller, where due to the rotation of the system of metal cone - rollers (there are 4) on which is wooden - cone roller, there is further floor winding on the wooden cone - roller to a certain extent that the worker determines. After determining a certain amount of winding, the worker manually scissors the flor on the wooden cone - a roller on two symmetrical pieces and removes them from the same one for the winding of the new web. Windings that are removed from the wooden cone - a roller are called "cones".



*Picture 10: worker who is winding flor on the wooden cone - roller*



*Pictures 11,12: Measurement of the formed "cone" on the precision beam scale*

*Picture13: Measurement of the size of the "cone" of the template*

Depending on the type of hat it will depend on the weight of his "cone". The number of windings on the wooden cone-roller depends on the required mass of the "cones". The white "cone" is always thinner, while the melange "cone" in comparison to white - thicker. The "cone" heaviness depends on the size of the cone. The larger the heaviness, the larger the cone. When it comes to adjusting the width of the table at the picking room, it also depends on the cone, and it is adjusted on the basis of the width of the cone in order to obtain high-quality picked wool without holes or the possibility of being too small. The thickness of the flor is corrected by means of a gear located under the picker.

**Example of adjusting the cone, gears and table widths when placing:**

**I cone**                                    200gr - 240gr

Gear wheel 11

Table widths when placing

**II konus**                                    145gr - 180gr

Gear wheel 9

Table widths when placing 33cm

- 
- 
- 

**VI konus**                                    75gr - 85gr

Gear wheel 2

Table widths when placing 33cm

The example shows that greater heaviness has a larger cone.

**I cone > VI cone**

## FELTING

The specific feature of most wool types is that in the aquatic environment under the effect of swelling voltage, they move and interpenetrate, and assisted by the external forces of pressure, impact and movement comprise and thereby create a more or less dense material known as **felt**.

The intensity of the interleaved fiber interaction and the increase in the density of the formed felt increases with increasing fineness and wrinkling of the wool by addition of water, chemical agents of alkali, soap or acid, and increasing the intensity of movement and mechanical forces and the temperature of the solution.

Felting is, therefore, a consequence of the bilateral assimilation of the corstices and the scale like surface structure and is only expressed on fibers in the wet state. The friction between the wool fibers expressed by the difference in the swelling of the components and the cortex, and in particular the friction in the mutual movement of the fibers caused by the mechanical field of force, is not the same, it is already greater when moving versus the scales of friction in the direction of the scales. The difference between these two friction coefficients is abbreviated by the DFE (Differential Frictional Effect) and is used as a measure of the ability to felt.

In addition, it is also referred to as the directional frictional effect. The force between fibers in friction of wool, as well as other fibers, can be expressed as a function of general form: [4]

$$F = f ( v, N, S )$$

Where is:

v- speed of movement of fibers

N- normal component of the force that causes friction

S- cohesion between fibers due to their mutual friction and locking

### Steam pressing of cones on the "felt-machine"

Cones removed from the cone-picker are velvety in appearance and soft to touch (Picture 12). In order to obtain a solid structure of the cones, it will be subjected to the steam pressing process on the felt machine.

Felt- machine consists of the following elements:

1. stand
2. lower felt panel
3. upper felt panel
4. electric motor
5. electrical couplings and switches
6. pneumatic (air) distribution system

Steam pressing of the cones on the felt machine is carried out as follows:

1. A cone that comes from a cone-picker first go to the "head" picking sensation on a mold that has a movable press in the form of a mesh called "butterfly". The "head" of the cone is formed on the mold and is base for the beautiful look of the cone itself, and also serves to avoid unwanted wrinkles in the further process of felt.



*Pictures 14,15: Felting of the head of the cone*

2. The worker brushes the work surface of the lower and upper felt panel from the impurities that were accumulated during the process of felting in order to avoid damage to the cone (making fissures) during felting.



*Pictures 16,17: Cleaning of the working surface*

3. Preparing the fcone for felting. The cone is prepared by placing a patch of a certain size inside the cone cavity that separates the upper and lower sides so as not to merge the wool during felting.



*Pictures 18,19,20: Placing a patch inside the cone*

4. Place the prepared cone on the felt machine. The worker first puts the cone on the left lower-panel that has a narrower head, turning on a pneumatic vent which with the aid of air device and electric motor, performs straight-line lifting and lowering of the upper felt panel, whose task is to execute the clutch pressure when lowering. The cone is positioned so that the "head" of the cone is not pressurized to prevent deformation of the shape.

In the further process, the worker raises the upper panel, takes the cone, turns on the non-felted side and moves it to the right bottom panel that has a wider head, turns on a pneumatic vent which with the help of air device and electric motor, performs straight-line lifting and lowering of the upper felt panel, whose task is to execute the clutch pressure when lowering. This ends the process of felting the cone that goes further to control.

The duration of the felting depends on the thickness of the cone and is expressed in seconds. Depending on the time of the felting, the pressure of the panel is adjusted, which in this case was 4 bar.



*Pictures 21,22,23,24: Placement of the cone on the felt-machine (felting)*

## CONCLUSION

This paper describes the technology of conical picking and felting in the manufacture of cones on the example of the company "Capital group". Felting is a very demanding method that is still being perfected and examined both by us and abroad. "Capital group" is currently the only company in Serbia that produces felt suits, hats and knit berets. With four years of work, the company managed to maintain quality in order to achieve a high level of placement on the foreign market.

## REFERENCES

- [1] <http://www.ekapija.com/news/926246/capital-group-u-rumi-otvorio-pogon-za-proizvodnju-vunenih-tuljaka-kaplina-i-sesira>, accessed april, 2017.
- [2] <http://www.begejhat.rs/srl/istorijat/>, accessed april, 2017.
- [3] Stepanović, J., Janjić, S. : Mechanical Textile Technologies, University of Banja Luka, Faculty of Technology, Banja Luka, 2015.
- [4] M. Tešić: Textile fibers for the 1st or 2nd grade of the four-year textile school, Institute for Textbooks and Teaching Resources, Belgrade, 2007.

## APPLICATION OF TEXTILE MATERIALS IN PLANE INDUSTRY

Teodora Šešum, V. Petrović, A. Milosavljević, D. Joksimović, J. Stepanović

\*Technical Faculty "Mihajlo Pupin", Zrenjanin,  
Đure Đakovića bb, 23000 Zrenjanin

\*Faculty of Technology Leskovac, University of Nis - The scholarship holder of the  
Ministry

E-mail - [teodora99sesum@gmail.com](mailto:teodora99sesum@gmail.com)

### ABSTRACT

*This document contains the application of materials used in plane industry, as well as application and textile used in making of astronaut clothes. The inside of the airplane and space aircrafts depends a lot on the use of many various trends in the textile industry. Textile and it's materials can be found in airplanes and in aerospace engineering and without these the industries are not competent today.*

*Aerospace consist of Earth's atmosphere and the area around it. Aerospace is actually compression aeronautics and spaceflight. Aerospace textile is one of the most important sections and is mainly built to save the life of passengers in the airplane industry. The end goal of aerospace is to protect human body from disasters or high frequency waves in the upper parts of atmosphere and space.*

**Keywords:** Aerospace, fibers, design, textile, airplane industry.

### INTRODUCTION

It's impossible to imagine inside of a plane without textile. The inside of the plane and spaceship depends a lot on various trends used in textile industry. Industry is constantly producing better and more advanced cables which unlike the past one that were made from rubber or plastic, are coated with durable textile. They often offer higher level of durability. The conveyor belts are being used in engines for cars, planes and spaceships. Al thought they were primarily been made out of flexible plastic and rubber in the past, textile mixtures showed durability in many areas of use. Modern materials such as micro fibers, nanotechnologies, and new forms of plastic have revolutionized the new use of textile in interior area.



Picture 1 : Application of textiles in the air industry

## TECHNICAL TEXTILE

Technical textile is defined as textile material and is primarily produced because of its technical performances and functionality instead of its aesthetic or decorative characteristics. Based on different characteristics, functionality and its application we can divide technical textile in the following groups:

- ⊗ Agro textile (agriculture, horticulture and forestry)
- ⊗ Building textile (Construction)
- ⊗ Clothing Textile ( Parts of clothing and footwear)
- ⊗ Industrial Textile (Filtering and cleaning)
- ⊗ Medical Textile (Hygiene)
- ⊗ Mobile textile products (Cars, Ships, Trains)
- ⊗ Eko textile (Environmental protection)
- ⊗ Aerospace textile (Airplane and spaceship textile)



*Picture 2 : Agro textile*



*Picture 3 : Honeycomb geo textiles*

## **AEROSPACE**

Textile and textile materials can be found in airplanes, cars and ship, in construction and decoration of the roads in aerospace engineering, without textile these things aren't relevant today. Aerospace consists of Earth's atmosphere and the space surrounding it.

Aerospace is actually one compression of aeronautics (science field used to explain flights in Earth's atmosphere) and spaceflight (movement of vehicles outside of atmosphere). Aerospace consist of full range of flights, while airspace industry is producing parts and equipment for things that fly. Massive reduction in weight makes fiber parts almost infallible in this industry. Today most of the airplanes are made out of plastic strengthen by fibers.



*Picture 4 : The interior layout of the aircraft*

## **RAW MATERIALS USED FOR AERO TEXTILES**

### **Carbonated fibers**

This is material which consists of very tiny fibers, ranging from 0.0002 to 0.0004 in diameter and usually contains atoms of carbon because it is produced as a by-product of oil cracking. It is also referred to as graphite fiber. It has great firmness, strength and really good heat resistance. Kevlar fibers are known for their ability to ensure quality and consistency which is a key component for aerospace application. Kevlar fabrics are mainly used in containment wrap, which has the important role in preventing damage on engine blades from damaging airplanes or entering the compartment of the passengers.

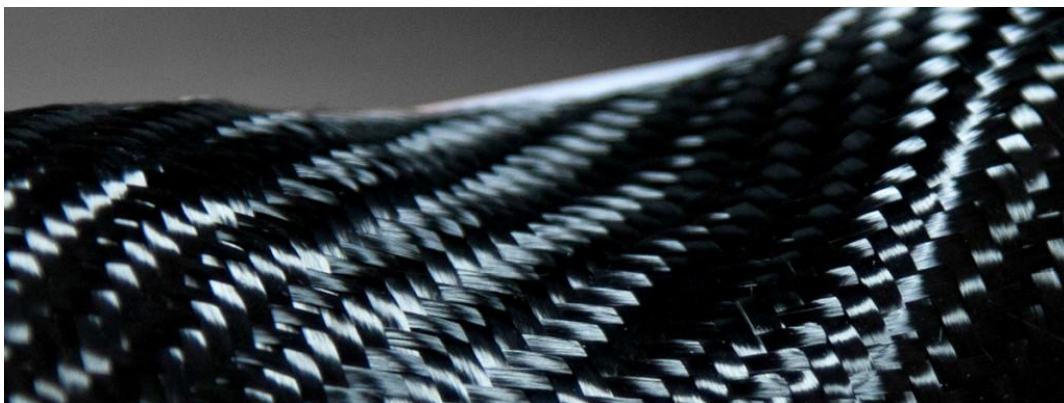

*Picture 5 : The appearance of carbon fiber*

### **Kevlar fibers**

Kevlar is the trade name for fiber aramids. These fibers are resistant to heat, have high strength and corrosion resistance. They have good fabric integrity even at elevated temperatures. Kevlar fibers are known for their ability to provide quality and consistency that are critical to aeronautical applications. Kevlar fabrics are used in protective linings that play an important role in preventing damage to motor blades from damage to aircraft or entry into the passenger compartment.

### **Nylon fiber**

Nylon 6.6 is made of hexamethylene diamine and adipic acid, which give nylon 6,6 a total of 2 carbons. It has great heat resistance, friction resistance and a melting point of 256 degree Celsius.

### **E- Glass**

E- Glass was originally developed for stand-off insulators for electrical wiring. It was later found to have excellent fiber forming capabilities and is used almost exclusively as the reinforcing phase in the material commonly known as fiber glass or glass fiber.

The essential properties of textile composites in aerospace applications are:

- ⊗ High specific modulus
- ⊗ High specific strength
- ⊗ Resistant to chemicals and organic solvents
- ⊗ Good fatigue
- ⊗ Thermal insulated and thermal resistant
- ⊗ Impact and stress resistant
- ⊗ Better dimensional stability and conformability
- ⊗ Low flammability
- ⊗ Non-sensitive to harmful radiations

Other Properties Required for Aerospace Textiles It is also need to consider incorporating maintainability requirements into aerospace materials. Some of the properties desirable from maintainability point of view are:

- ⊗ Washable
- ⊗ Abrasion resistance
- ⊗ Tear resistance
- ⊗ Moisture resistance
- ⊗ UV stabilization

Based on the applications, textiles used in Aerospace are broadly divided into:

- ⊗ Aircraft Textiles
- ⊗ Space textiles

The textile articles being used in aircrafts are mainly for the below purposes:

- ⊗ Wings, Body parts.
- ⊗ Curtains.
- ⊗ Upholstery fabrics.
- ⊗ Wall covers.
- ⊗ Head set.
- ⊗ Floor carpet/covering.
- ⊗ Seat covers.





*Picture 6 : Application of textiles inside the aircraft*



*Picture 7 : Application of textile materials*

## **AEROSPACE MATERIALS**

The most successful materials employed for manufacturing of aerospace textile and structures are composites. A composite is commonly defined as a combination of two or more distinct materials, each of which retains its own distinctive properties, to create a new material with properties that cannot be achieved by any of the components acting alone. Composites are often stronger than conventional materials and weigh less. Composites are formed by commonly incorporate a structural fiber and a plastic, this is known as Fiber Reinforced Plastics, or FRP. The fiber provides the structure and strength to the composite, while a plastic polymer holds the fiber together. The environment faced by the astronauts are very complex in space when compared to the Earth, where the gravitational attraction holds atmosphere comprising a mixture of gases like nitrogen, oxygen, carbon dioxide and thick form of water vapo and this atmosphere protects us from various factors.

So there is a need for a system to protect, determine, detect and prevent certain level of radiations, pressures and temperatures encountered by the astronauts to keep him alive in that environment.

A space suit is a complex system of equipment, specially designed to protect and keep a person comfortable in the rough environment of outer space.

Some of the Properties of a space suit must possess are :

- ⊗ Lighter in weight
- ⊗ Flexible in handling
- ⊗ Soft on touch
- ⊗ Comparable in strength with metal
- ⊗ Modifiable in size and shape
- ⊗ Thermal insulated and thermal resistant
- ⊗ Chemical Resistance

## **SAFETY SYSTEMS**

Safety systems are inevitable for all aircrafts. The safety systems while ensuring safety of the aircraft, passenger and do not directly contribute towards operational capability of the aircraft. Their addition into the aircraft thus brings a weight overhead and it is a challenging task for the designer to minimize their weights. Fabrics are now universally and extensively used in the design of safety system of aircraft due to their light weight and a host of other favorable properties.

## **BEGGININGS OF EXCITING DEVELOPMENT**

Research into specialist textiles continues to expand, and we may be on the cusp of developments that are still gathering momentum but are already progressing at quick pace. Scientists have long been researching potential applications for artificially produced spider silk, which should achieve extremely high take-up rates in industry. Once again, bionics make the decisive difference. Spiders produce an extremely tough thread, which is significantly stronger than steel fiber of the same thickness, yet with equal elasticity. If the scientists succeed in creating a cable made of spider silk that is as thick as a steel cable, the load-bearing and tensile strength, as well as the flexibility, would significantly exceed the equivalent values in steel. In other words, this means that applications that so far have required extremely thick steel cables could achieve significant weight savings by using spider silk. In bridge construction alone, countless tons of steel could be saved, while maintaining the same overall strength. However, steel cables are also used in aircraft and ships, and as such, it may be possible to make use of bionics to achieve more efficient designs. Even in the age of fly-by-wire, where traditional cable and hydraulics-based systems are no longer needed, spider silk could be incorporated into other textile products. Seat frames could become thinner and lighter without reducing their strength, and functional clothing could also benefit from this potential new material.



*Picture 8 : The application of textiles in the creation of astronomical games*

The future of modern textiles in the aerospace sector, in aerospace interiors and bodies, as well as in functional clothing, will be vital for the future development of high performing aircraft and spacecraft. Low weight, high strength, cost efficiency, ease of working with the materials, and safety are all parameters that can only be achieved using other materials with difficulty, if at all. Innovations, such as incorporating bionics into the development of new textile solutions, will open completely new solutions for engineers and scientists. Before the theory can be put into practice, the challenge of developing efficient production processes will always remain so that ideas such as versatile spider silk can be transformed into a practical reality.

## **CONCLUSION**

Aerospace textiles are the one of most important sector which is mainly built to safe guard the life of an aerospace traveler. The ultimate aim of the Aerospace textiles is to protect the human body from a disaster or from the high rays in the upper layer of the atmosphere and spaces. The development of these textiles is a great boon to the current textile industry. Today these kinds of textiles are making a significant contribution to the increasing market for textiles. Even though a lot of aerospace programs have started using advanced composites, lesser industries are aware of the development in this growing area of composite technology. This is due to lack of access to this technology and local manufacturing composites at a reasonable cost. There is lot of scope for research and development in aerospace textiles and also for horizontal and vertical growth in aerospace textiles to save the life.

## **LITERATURE**

- 1) <https://www.go-textile.de/branche>
- 2) <http://textilelearner.blogspot.com/2014/07/what-is-aerospace-textile-application.html>
- 3) <https://arts.eu/blog/textiles-in-industry-the-importance-of-modern-textiles-in-the-aerospace-industry>
- 4) <http://textilevaluechain.com/index.php/article/technical/item/258-composite-textile-applications-in-aerospace-technology>

## TESTING OF STRENGTH OF COTTON FABRICS OF DIFFERENT DENSITIES BY WEFT IN INTERTWINE OF LINEN

Anita Milosavljević, V. Petrović, D. Joksimović, S. Sindelić

\*Faculty of Technology Leskovac, University of Nis - The scholarship holder of the Ministry

\*Technical Faculty "Mihajlo Pupin", Zrenjanin,  
Đure Đakovića bb, 23000 Zrenjanin  
mail: [anita.milosavljevic@hotmail.com](mailto:anita.milosavljevic@hotmail.com)

### ABSTRACT

*The goal of this paper is to get the best strength, that is, the force of the fabric during tearing and damage, to determine the greatest elongation of the fabric, but also to determine where is the weakest, and its minimum elongation. In order to obtain such results, different densities of the base and stem wires and fineness of the fabric were determined, and the density of 10, 15 and 20 cm<sup>-1</sup>, and fines 50, 33 and 20 tex per stream. In company Boris komerc from Arilje, the selected item is Chifon: raw material composition 100% cotton, gp 21.5 cm<sup>-1</sup>, 25.3 cm<sup>-1</sup>, weight 110 m<sup>-2</sup> to 190 m<sup>-2</sup>, fine fin 50 tex - a, the basis of fineness 30 tex, in the canvas intertwine. For the purposes of testing this article has changed the density and fineness of the stream. In this paper, samples of different densities of rocks were tested: 10 cm<sup>-1</sup>, 15 cm<sup>-1</sup> and 20 cm<sup>-1</sup>. Also, the different finishes are as follows: 20 tex, 33 tex and 50 tex. For each density and fineness, five samples were prepared in the direction of the base and the course of the dimension: 10 cm wide and 30 cm high, which were examined on the dynamometer, while the weaving of the fabric was carried out on the FIMTESSILE RP120 type. For each density of rusted wires and fineness, five samples were prepared and tested in the direction of the base and in the direction of the stream, which were examined on the dynamometer.*

**Key words:** Fabric strength, canvas interlacing, density.

### 1. INTRODUCTION

Woven fabrics are flat textile products obtained by interweaving two wire systems at right angles in a certain intertwinning. Fabrics are stable and compact textile materials suitable for making clothes and many other textile products for different purposes (conventional, technical and medical textiles).

The longitudinal wire system is called the base, and the crosswalk system; The upper side of the fabric is the face, and the lower side is the back. Interweaving the base with the stream is done according to the established laws, which are determined by the appropriate constructive solutions of the fabrics, whereby the product of the designed characteristics is obtained.

The way the wire wire system is crossed with the weft wire system is called the interlacing of the fabric. There are a large number of different interlacing fabrics. The paper examines cotton fabrics in a canvas interlace. The cloth interlacing has the simplest and densest construction and the same look on the face and back. The schematic representation of the base and the rocks in the cloth interlace is shown in Image 1 [1].

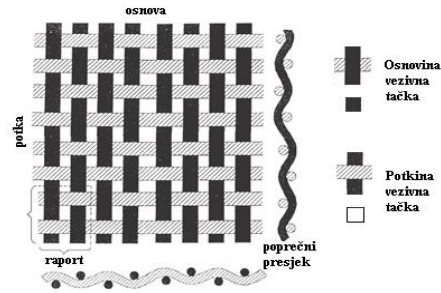

**Image 1.** The schematic representation of the basis and the rocks in the canvas intertwine

Fabrics differ in each other according to the properties, which are largely determined by their structure and raw material composition. Fabric properties affect their reproducibility and application.

The density of the wires in the fabric means the number of wires arranged per unit of length, that is, the width of the fabric. In this case, it is usually 1 cm, so the wire density unit is in fabric cm<sup>-1</sup>. The density of the base (gp) and hollow (gp) wires is particularly expressed when densifying the wire density. According to the density of the wires the fabrics are divided into thick, medium density and rare. Dense fabrics are those in which the space between the adjacent wires is smaller than the diameter of the yarn. Midweight fabrics are those in which the space between the adjacent wires is equal to the diameter of the yarn. Rare fabrics have a larger intermediate space between adjacent wires from the diameter of the yarn. The maximum wire density (g<sub>max</sub>) indicates how much wire of the given diameter (d) can be placed one to the other on the unit of length, that is, the width of the fabric.

## 2. TESTING THE MECHANICAL PROPERTIES OF THE FABRIC

Mechanical properties of fabrics depend on fiber properties and physical-mechanical characteristics of yarns. Mechanical properties are determined by the action of static and dynamic forces. Experimental method, the effect of static forces determines the values of breaking force and interrupted elongation. These values can be obtained depending on the direction of testing: for fabrics in the direction of the base and the crest.

A universal dynamometer was used to measure the breaking force and interrupted elongation of the tested samples under the action of static forces *Tenso Lab3 2512A - Italian manufacturer Mesdan*.

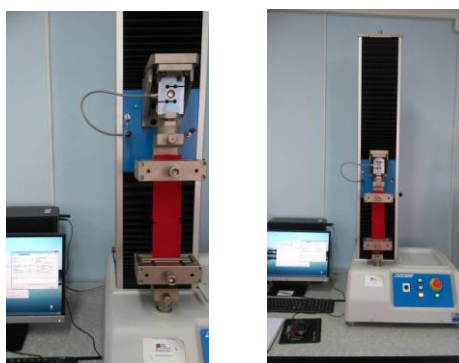

**Image 2.** Displays the *Tenso Lab3 2512A* dynamometer during sampling

Values for intermittent force and elongation are read on the dynamometer at the moment of the tube tearing. In addition to direct reading of these characteristics, the dynamometer also has the ability to display the curve F-ε in electronic form. Image 4 shows the curves F-ε in the direction of the base and the sweatshock when examining the fabric made in a cloth interlace. For fabrics the size of the test tube is determined according to the standard SRPS F.S2.017. entitled: Physical textile testing - Determination of intermittent force and elongation of fabrics.

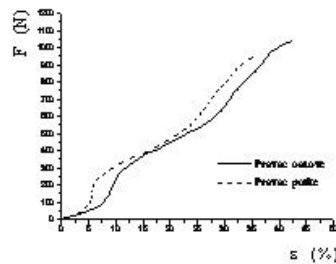

*Image 3. Experimental curves  $F - \epsilon$  in the direction of the base and the stream [3]*

### 3. GOAL AND TASKS OF THE RESEARCH

Clothes are constantly exposed to various stresses, these stresses depend on body movement, clothing, fabrication, and quality of the material. Too much straining can cause damage to materials and clothing, different deformations, and most often this happens on the material itself. Solving this problem requires a series of research, fabric testing and data processing.

At the company Boris komerc from Arilje, the article Chifon was selected for testing: raw material composition 100% cotton, gp 21.5 cm<sup>-1</sup>, 25.3 cm<sup>-1</sup>, mass 110 m<sup>-2</sup> to 190 m<sup>-2</sup>, fine fin 50 tex -a, the basis of fine 30 tex, in canvas intertwine. For the purposes of testing this article has changed the density and fineness of the stream. In this paper, samples of different densities were studied along the streams: 10 cm<sup>-1</sup>, 15 cm<sup>-1</sup> and 20 cm<sup>-1</sup>. Also, the different finishes are as follows: 20 tex, 33 tex and 50 tex. For each density and fineness, 5 samples were prepared in the direction of the base and the course dimension: 10 cm wide and 30 cm high, which were examined on a dynamometer. The obtained results are presented in the following section on the tables where the smallest and maximum force, ie, the severity of the tissue samples can be seen, and the greatest elongation. The weaving was carried out at the FIMTESSILE RP120 type.



*Image 4. Weaving on FIMTESSILE RP120*



*Image 5. Weaving fabrics of various densities and fineness on debauchery*

Attached to the paper are attached diagrams drawn with a dynamometer during testing of fabric or samples. Histograms are also shown for more precise comparison of the different fineness of the fleece and the density of the weft fabric fabric. This is for the sake of better visibility of the results, that is, in order to determine as accurately as possible the smallest and greatest force of tearing and elongation and what leads to and influences these values.

## 4. RESEARCH RESULTS

### 4.1. The comparison of different densities and the fineness of rugged wires

In the following work, a comparison was made of the results obtained, since the three densities of the perpendicular wires  $\text{gp in cm}^{-1}$  (10, 15 and 20), and three different fineness of the streams in tex (50, 33 and 20) were observed. The goal was to determine how the strength and elongation of the fabric changes for each fineness of the rugged wires, at different fabric densities. The obtained results are shown and compared to the histograms where changes in the strength of the fabrics are observed depending on the different densities and the percolation fineness. There are signs of interrupting the forces of the fabrics and intermittent elongations, both on the rugged and the basic wires.

#### 4.1.1. Comparison of the fineness 50, 33, 20 by the densities of the stranded wire 10, 15, 20

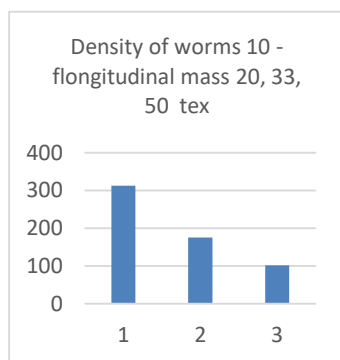

*Image 6.*

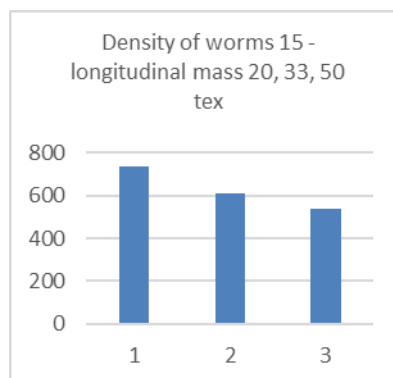

*Image 7.*

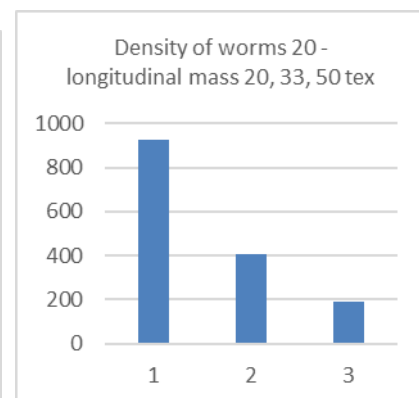

*Image 8.*

**In images 6. 7. i 8.** Each density of the rusted wires, regarding the fabric individually at which the three fins of the weft wire have been changed, is shown. The fins 20, 33 and 50 tex were changed in the direction of rugged wires, where we can see what happened with a fabric that was 10, 15 and 20  $\text{cm}^{-1}$  density, or how the force changes in the density of rusted wires. With the density of 10  $\text{cm}^{-1}$  of the stranded wire, according to the results, we see that the maximum tearing force of the fabric 313N, at a fineness of 50 tex in the direction of the rusted wires, and the smallest 101.8 N, at a fineness of 20 tex wires. At a density of 15  $\text{cm}^{-1}$  of the perforated wire, a comparison of the fineness showed that the maximum force for the fineness of the fabric is 50 tex and amounts to 538N. The smallest was also shown at fin 20, it is 146.8N. While at densities of 20 stranded wires, the highest tearing force per pot was shown at 50 tex fineness and amounted to 927.8 N, while the smallest 189.6 N at the fineness of 20 tex. When all the crushing forces of the tested fabrics are compared, in all the fines and densities studied, the maximum tear strength for the fabric with a maximum density of 20  $\text{cm}^{-1}$  is seen, and it is 927.8N at a fineness of 50 tex. The minimum tensile force is at least 10  $\text{cm}^{-1}$  and is 101.8N. Such force and strength have been demonstrated due to differences in the density of rusted wires.

Observing all the densities of rusted wires and with each fineness, we can conclude individually that in the case of fabrics with higher density of buried wires, the strength increases, while in the case of

fabrics with lower density, this strength decreases. For larger densities, due to the higher number of threads of threaded wire, it is more difficult to crack and the strength of the fabric is higher. Also, when the density is smaller, the number of threads in the fabric is smaller and the tensile strength is smaller

**4.1.2. Comparison of all fineness individually according to different densities of woven wire strands**

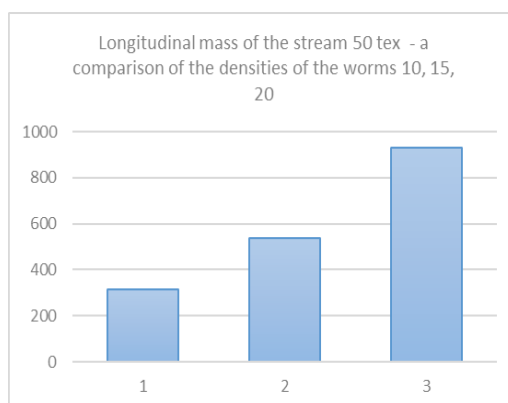

**Image 9.**

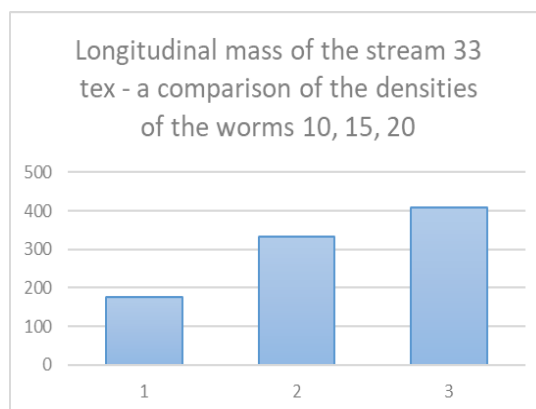

**Image 10.**

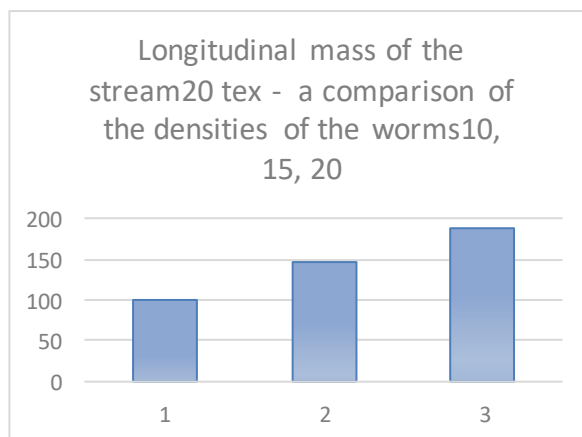

**Image 11.**



**In images 9. 10. i 11.** Histograms are shown for all the studied finenesses of the streams individually compared to different fabric densities in the direction of rusted wires.

Each of the fineness is compared to all the densities of the woven wire of the fabric.

For the fineness of the tex 50 tex, the thickness of the weft wire of the fabric is 10cm-1, the strength is 313N. At a density of 15cm<sup>-1</sup>, the strength is 538N, and for the density of rusted wires 20 cm<sup>-1</sup>, the strength is 927.8N.

For the fineness of the texte 33 tex, at the density of the fabric in the direction of the weft wire 10cm-1 the strength is 175N, at a density of 15cm<sup>-1</sup>, the strength is 333,6N, while at a density of 20cm<sup>-1</sup>, the strength is 407,6N.

For the fineness of the 20tex stream, the thickness of the weft wire of 10cm<sup>-1</sup> fabric is 101.8N. The same fineness, but in the case of other densities of rusted wires, that is, at a density of 15cm<sup>-1</sup>, the strength is 146.8N, while at a density of 20cm-1, the tear strength of the fabric for the same fineness of the stream is 189.6N.

When the obtained values are compared, it can be concluded that the thickness of the rugged wire of 20 cm<sup>-1</sup> of the tissue breaking force is the highest, with a fineness of 50 tex, in comparison with the fins 33 and 20. In this case, the fabric is made of linen interlining, a fin of fin The 20 tex, at least the density of 10cm<sup>-1</sup> of the percussive wire, showed the smallest strength. The strength of the fabric is an important indicator. Although the smallest density of the weft wire or the thread's fineness in fabrics most often shows higher stretching and / or elongation values. In the continuation of the paper, the values of the elongation of the fabrics, depending on the different fineness and density of the rugged wires, are shown.

### **5. Elongation of the fabric – an indication for each density of the stitched wires individually according to the different finishes of the linen interlace**

The following figures and histograms show the mean values for each of the five samples for each combination of the change in the density and the fineness of the stream, ie, the rocks. Based on these results, the measurements show the obtained stretch values in order to determine where the fineness of the fabric and the density of the weft cords is achieved by the highest stretching, or where the least stretching is obtained in comparing the obtained values of the different fineness and density of the roots.

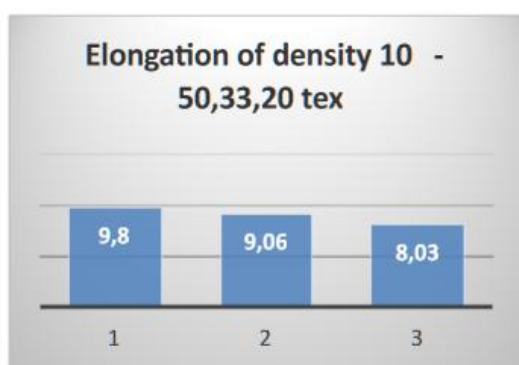

**Image 12.**

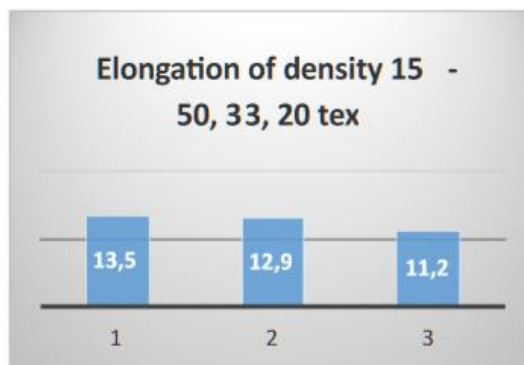

**Image 13.**

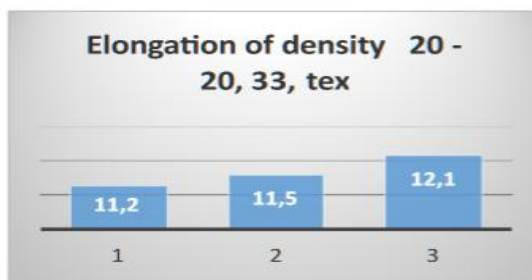

**Image 14.**

**In images 12., 13. i 14.** Histograms of elongation are shown. - In the case of the densities of the rocks, 10cm<sup>-1</sup>, with different finishes, different elongations have been achieved. At 50 tex fineness, the elongation is 9.8 mm, at a fineness of 33 tex, the elongation of the fabric is 9.06 mm, and at a fineness of 20 tex, the elongation is 8.03 mm.

By changing the density of rusted wires from 10cm<sup>-1</sup> to 15cm<sup>-1</sup>, the samples increased the elongation. Thus, with a fineness of 50 tex, elongation on the fabric as much as 13.5 mm, with a fineness of 33 tex, a medium elongation of 12.9 mm was achieved, and at a fineness of 20 tex compared to other fins - at least 11.2 mm. For the thickness of the 20cm<sup>-1</sup> wire and the 50 tex fin, the elongation is 11.2 mm, with a fineness of 33 tex, the elongation is 11.5 mm, and in the third fin 20 the tex elongation is 12.1 mm.

According to these results, by comparing the interrupted elongation of fabrics with different fabrics finishes, for each density of rusted wires, it can be determined where the fineness and fineness of the fins and density have been produced, as well as the smallest ones. In the case of the densities of the stranded wire 10cm<sup>-1</sup>, the maximum elongation is 9.8 mm at a fineness of 50 tex. At a density of 15cm<sup>-1</sup>, the greatest elongation occurred at a fineness of 50 tex and amounted to 13.5 mm. It can be concluded that the greatest elongation occurred with the highest fineness of the stream, fineness 50, and in this case it is 13.5mm for the density of the 15cm<sup>-1</sup> wire rope. This contributes to the structure of the fabric, since it is possible to achieve greater elongation even at the lower fineness of the stream. But with less fineness and finer materials, the damage is considerably higher, so the thicker materials and the elongation turned out to be larger. The disadvantage of the smaller fins of the rusted wires is their breaking strength, because in the event of damage, cracking, materials with a greater fineness of the pot are stronger. The confirmation of this assumption is the least achieved elongation occurring with the lowest fineness and density of the rope wires 10cm<sup>-1</sup>, the elongation is 8.03mm.

**Image 15** shows a histogram of the common values of the greatest elongations of all the densities achieved at the 50 tex fineness according to the results obtained, but where the least stretching between them can be seen.

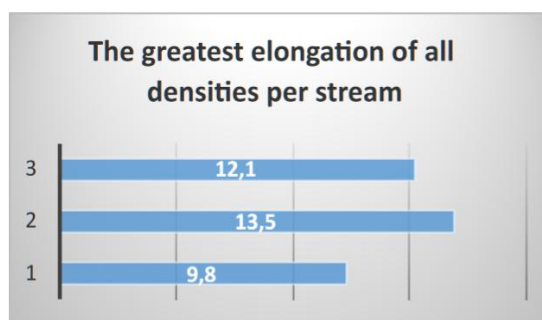

**Image 15.**

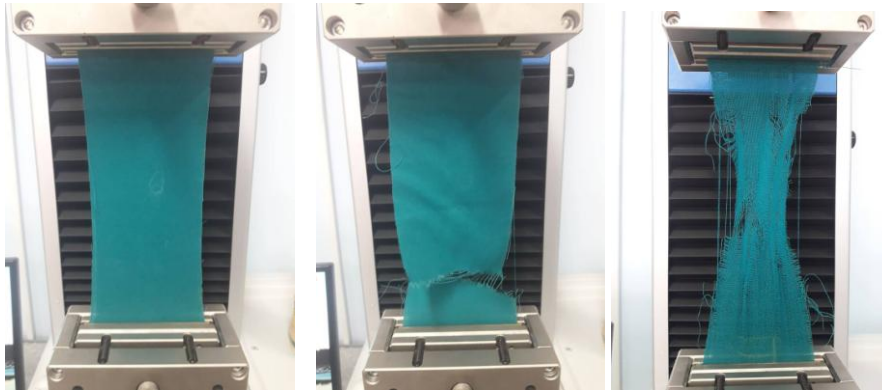

*Image 16.*

*Image 17.*

*Image 18.*

**In image 16.** – A larger-texture fabric is placed for testing on a dynamometer.

**In image 17.** – Sharpening of the fabric of higher density of rusted wires is shown, where there is noticeably less damage to the fabric in comparison with the smaller density fabric.

**In image 18.** – The fabric is of lesser fineness and with a slight elongation at the force of the stress on the diagram and with noticeable damage due to the structure of the fabric.

## 6. CONCLUSION

For each density of rusted wires and fineness, five samples were prepared and tested in the direction of the base and in the direction of the stream, which were examined on the dynamometer. According to the results obtained, there were no major deviations in the direction of the base except in one diagram, where there was a fault on the dynamometer and on the diagram when measuring during the burst of the fabric on the dynamometer. Due to the lack of these samples, the measurement was not repeated, and there was an increase in value towards the base. Other diagrams and calculations show roughly the same or similar values. For all values, tabular results are shown, but more detailed tests and explanations in the work were based more on the achieved strength and elongation in the direction of the stream when changing the density of rugged wires and fineness of fabrics.

The test shows the following results: it can be concluded that the density of the weft wire is 20cm<sup>-1</sup> the most robust, at a fineness of 50 tex, compared with fines of 33tex and 20tex. The strength of the fabric is significant.

Although the smallest density or fineness of the fabric can lead to greater stretching or elongation. The lightweight 20tex pots, at the lowest density of 10cm<sup>-1</sup>, showed the smallest strength.

When all the crushing forces of the fabrics which were examined were compared, the greatest force was shown for the fabric with the highest density of the stumps, with a density of 20 cm<sup>-1</sup>, which amounted to 927.8N and with that the finest fineness of 50. The smallest breaking force was shown at the lowest density dorsal wire, density 10cm<sup>-1</sup> and was 101.8N.

When results are observed in the direction of the basic wires, it can be seen that the samples in the direction of the basic wires of 15cm<sup>-1</sup> density and 50tex fineness proved to be the strongest. The strength was 737.8N, and the elongation was 53.55mm. Compared to the density 10 cm<sup>-1</sup> and 20 cm<sup>-1</sup> also examined in the direction of the basic wires, but according to the different densities and fineness of the stream 20tex, 33tex and 50tex, where the tissue tearing and elongation turned out to be weaker.

Especially when compared with samples with a density of 20cm-1, where the strength was best at 50tex fineness, it was 927.8N.

The conclusion itself could be that, in order to achieve as much strength and elongation as possible, the density of rusted wires and the fineness affecting the strength of the fabric is crucial. Observing all the densities and fineness, one comes to the conclusion that in the case of fabrics with higher density in the direction of the submerged wires, the strength increases, while in the case of fabrics with a lower density of the stranded wire, the strength increases and the shear of the threads becomes easier.

With a larger number of wires, the cracking is more severe, the strength is higher. When the number of rusted wires is smaller, the damage is easier and more often.

## 7. LITERATURE

- [1] J. Stepanović, S. Janjić: Mechanical Textile Technologies, University of Banja Luka, 2015.
- [2] Technical information of the manufacturer Mesdan, 2016.
- [3] D. Radivojević, M. Đorđević, D. Trajković: Textile testing, High School of Textile Textile, Leskovac, 2016.
- [4] Research into the influence of qualitative characteristics of fabrics on thermophysiological properties of clothes - doctoral dissertation – Mirjana Reljić – Leskovac 2016.
- [5] D. Rogale. D. Ujević, S. F. Rogale. M. Hrastinski: Processes of garment production, Zagreb, Faculty of Textile Technology, University of Zagreb, 2011
- [6] V. Petrović, J. Stepanović, M. Stanković, M. Reljić, S. Stefanović: Contemporary trends in the textile and clothing industry in Europe, Management, Innovation, Development, Volume 8, No.1, p. 83 - 89, (2013). UDK005, ISSN 1452-8800.
- [7] A. Kunštek, B. Knez: Damage to seams on clothes, Textil - Zagreb, 35 (1986) 6, 389-402
- [8] U. Schmid, J. Mecheels: Kräfte an Textilien und Nähte der Kleidung in Abhängigkeit von
- [9] Körperbewegungen und Kleidungsschnitt, Bekleidung + Wäsche, 33 (1981) 2, 77-82
- [10] В. Ф. Шаньгина: Структурная схема показателей качества соединений деталей одежды, Технология легкой промышленности - Москва, 26 (1983) 2, 113-117
- [11] Е. Б. Коблякова: Структурная схема показателей определяющих уровень качества одежды, Швейная промышленность - Москва, (1976) 2, 10-11, (1976) 3, 21-24
- [12] D. Rogale. D. Ujević, S. F. Rogale. M. Hrastinski- Processes of clothes production, Zagreb, Textile - Technology Faculty, University of Zagreb, 2011.

## IMPACT OF PRODUCT QUALITY AND MARKETING ON THE SALES OF FASHION PRODUCTS

**Valentina Bozoki**

\*Technical Faculty "Mihajlo Pupin", Zrenjanin, -  
Đure Đakovića bb, 23000 Zrenjanin  
e-mail: [vajnica.bozoki@gmail.com](mailto:vajnica.bozoki@gmail.com)

### ABSTRACT

*Marketing today plays a major role in achieving higher goals of selling fashion garments, as well as their quality. The fashion product must have quality, be interesting and good looking to attract customers and thus retain it. How many people are going to hear about you and your product, and whether they will want to buy it depends on the marketing. It is therefore important to have a good team of people who will dedicate themselves to this job and achieve good results for the whole company, because if the company has a good marketing team, more than half of the work will be done.*

**Keywords:** marketing, fashion, fashion products

### 1. INTRODUCTION

It is widely known that *fashion* is a term used as a name for new and transiently accepted styles and ways of dressing. It isn't only used in this sense, but also for hairstyles, art, sports, literature, music and the like. Fashion in textile industry is today's large factor that strongly influences the overall business results. In order for a fashion product to come into the market and stay there, it must meet the criteria set by the consumers themselves, that is, buyers. Marketing today plays a major role today in achieving these goals, and it is a set of activities that are used to guide the flow of products and services from the producer to the consumer. And because of its great impact on the sales market, special attention is paid, as well as the very quality of the product that is crucial. By the quality of a product we mean a set of all the features that one garment must contain, which are:

- functionality
- ergonomics
- simplicity of maintenance
- the look of the product itself etc...

Quality is one of the important features of a particular product that has a prescribed or required level of accomplishment with optimal productivity and economy during the production process. It is a big task for manufacturers to adapt products to the wishes and demands of consumers. Fashion is changing, but the quality of the product should always remain the same in order to keep the buyers.

### 1. ABOUT FASHION INDUSTRY AND FASHION

*"Fashion is not just an object of interest for avant-garde and leisure, today it is a global phenomenon and a huge demand factor in a big business industry, the fashion industry." (Milan Gašović)*

*Fashion* is a social phenomenon that is all in all related to change. Considering that we can say that fashion exists in all human activities and all spheres of life, from technical-technological, through medical to cultural, artistic, etc. In any case, whatever it may be, fashion is a major driver of development, an inspiration for all process participants from production, through distribution, sales, and the development of products and services. The term "*fashion*" has a linguistic origin from the Latin term "*modus*" (way of life, a set of customs, a culture of a nation or group) and, in the first place, it is the name for new and transiently acceptable forms of life. When we say fashion, it is mainly thought of as a new way of dressing, however, this term is much more complex. In addition to the new way of dressing, fashion also includes other important aspects such as lifestyle, behavior, literature, music, sports, design, art, architecture and a lots of other areas. Everything depends on fashion today and it always has to keep up with it. The data shows that the fashion industry is extremely developed in the world, employs a huge number of people and takes about one-sixth of the world's total consumption.

The production and sale of fashion products is an enormous business that has a direct impact on the trends and overall business results of other industries, where the application of marketing plays a crucial role in the fashion industry. Reviewing the fashion marketing process includes the role of this modern fashion business model and all ethical issues that marketing is starting within this context, with some practical examples from the scope of work of fashion marketers.



*Photo 1. Fashion today*

As an exceptionally dynamic area, fashion is characterized by constant, exciting changes in the domain of creativity on global level. However, creativity in the domain of the fashion industry is not sufficient for itself and requires a number of other skills that will support these new ideas and creations in order to survive, gain their consumer audience and ensure their planned survival on the market.

The textile, clothing, leather and footwear industry represents significant production branches in the Serbian economy, import is dependent and export oriented, labor intensive, especially textile industry. Both sectors have a tradition in the European and world markets. Production is organized in small, medium and large productions.

## **1. FASHION PRODUCTS – FASHION GARMENTS**

Clothing industry products (clothing items), by their dynamics and influence that have fashion trends on consumer choice, are the most important, basic elements of the marketing mix.

Modern dressing is part of the human intimacy and the expression of his personality. Therefore, there is no problem for manufacturers of clothing products to match their products with the wishes and demands of consumers.

Fashion items can be classified into three groups:

- High fashion clothing
- Clothing items of the followed up collection
- Clothing - fashion collection

High fashion clothing are unique, that are mostly made according to the rules dictated by the largest fashion centers such as Paris, London, Milan ... the originality and quality of these models are guaranteed.



*Photo 2. High fashion clothing (Boris Kargotić, designer)*

The followed up collections are created in high fashion fashion houses as a supplement to high fashion collections.

Fashion collection at different prices provides the latest fashion trends to the wide market, and satisfies many tastes and different age groups of consumers. Various social groups are supplied with a variety of assortments.

## **1. PRODUCT AND ITS QUALITY**

Product as a term

The product is the result of human labor, which, by its physical, chemical, aesthetic or other characteristics, satisfies the human needs of any kind, which has usable value for man. ( Petrović 1997, book source Eleonore D. 'Industrial design')

The product is the most complex element of the marketing mix. Marketing experts should ensure that products are constantly adapted to the requirements of consumers. There are two basic ways to develop new ideas:

- product adaptation
- product development



*Photo 3. Fashion product*

Sometimes both methods are used at the same time to create a collection. Changes in the market are getting faster, so a huge effort by manufacturers, designers and retailers is required, as well as the precise termination and alignment of their activities so that the right models are available at the right time and in the right place for consumers.

## **1. MARKETING – FASHION MARKETING**

The concept and basic characteristics of marketing

*Marketing* is a system of interconnected activities that seek to realize the business goals of the company, conditioned by the market and business environment. Marketing is aimed at satisfying two basic interest groups:

1. The interest of consumers to optimally meet the needs, requirements and wishes
  2. The interest of enterprises in production and business that have more aspects, but the main profit
- In addition, marketing is a business activity and a strategy that focuses on orienting and establishing business relationships with the market and the business environment. Design and marketing in an enterprise must operate in an integrated, coherent and timely manner.

## **PRODUCT QUALITY**

This feature is especially important for the design and production period, and it contains 4 components:

- Technical. These include technical characteristics that are controlled in the production process: dimensions, composition, quality of treated area ...
- Aesthetic: size, shape, appearance, color, appeal, product packaging
- Economic: product prices, production costs
- Ergonomic: human adaptation



The very expression of product quality is a complex concept and is a constant human companion in everyday life and work, like a user and as a manufacturer. Like a quality is provided having all measures and procedures done so in order to achieve the goal in sync with the set quality plan that includes: quality planning, management and testing.

The products are high quality if they are proven to be durable or economical in use. Products must satisfy the overall customer requirements in terms of price, deadlines, delivery, cost-effectiveness, and so on. When purchasing goods, the buyer requires proof of quality, and this is obtained through contracts and authenticated test protocols of legal nature.



*Photo 4. Product quality*

The quality of the product depends on a number of factors affecting itself as shown in the picture above (Photo 4).



Photo 5. Marketing plan

*Fashion marketing* is quite similar to marketing any product. Integrating brand into the product is something that is always popular in the fashion world especially for many popular retail fashion products. Fashion marketing can be perceived in two ways; one is marketing for the fashion conscious consumers and the other is marketing to distribution channels such as retail franchises. Fashion marketing basically focuses on promoting, publicizing and increasing awareness of a particular brand or designer.

A person pursuing a career in this line should have the skill of strategically pushing a product into the limelight. A fashion marketer should be able to recognize the target audience and the needs of the consumers.

This information will be the base point on which the strategies will be developed. Advertisements, public and media interaction, social media, events and magazines are used by a fashion marketer intelligently to create awareness.

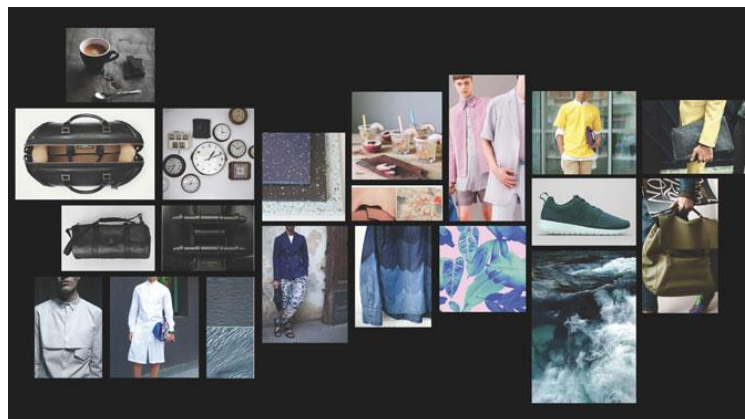

Photo 6. Fashion marketing

Knowing and applying marketing principles is important in every business activity, but in the domain of fashion industry, they are crucial to opening opportunities and the path to safe success and avoiding failure. Domestic, and especially world-wide experiences of fashion companies and brands confirm the fact that marketing is closely related to creations and their marketing placement, which practically suggests that marketing in the fashion industry or fashion marketing finally brings together the entire process - from the creation of products or creators, through consumers / buyer and finally making profits. A good knowledge of fashion marketing and all its performances is the different specificity that creates a clear difference between a model that ends up in a storehouse and a model that is desirable, which customers are looking for, buying and carrying.

## 6. CONCLUSION

To sum up the content of this work, marketing, product quality and product design themselves are closely related and depend on each other as well as on the team of people in charge of this type of activity. It is very important to have quality people in each of the listed and other necessary sectors in the company in order to comply all and that your product will appear and remain on the market in addition to all other products, satisfy your criteria and that of the consumers and create profit and satisfaction for the consumer and the manufacturer.

Fashion dictates what will be popular on the market in the next period and it is necessary to send it on time because fashion is not long term and if it is too late, there will probably be no profit for the company. Fashion is dictated by big fashion houses, while the rest are the followers. It is necessary to keep up with them, to keep in mind that the quality of the product is high and that a marketing team is organized in time to sell your product before the product of another company. As long as the company and the team in the company actively research and work on the product and on its marketing, the company as well as the employees get profit. It can be said that everyone will be satisfied, customers, companies and workers.

## 7. LITERATURE

1. 'Industrial design', eleonora d.
2. 'Fashion marketing', milica s.
3. <https://www.slideshare.net/ggland1/modni-proizvod>
4. <http://wwinlsf.blogspot.com/2014/05/career-in-fashion-marketing-fashion.html>
5. <http://www.dpm.ftn.uns.ac.rs/dokumenti/katedra0155/merenje%20i%20kvalitet/kvalitet%20pr oizvoda.pdf>
6. <http://www.flou.rs/modni-marketing-promocija-knjige-dr-milice-slijepcevic/>
7. <https://sh.wikipedia.org/wiki/marketing>

## AUTHORS ADDRESSES

**Moga Ioana Corina**

DFR Systems SRL, Drumul taberei 46, Bucuresti, Romania

[corinamoga@yahoo.com](mailto:corinamoga@yahoo.com)

**Dontu Octavian**

University POLITEHNICA, Splaiul Independentei 313, Bucuresti, Romania

[octavdontu@gmail.com](mailto:octavdontu@gmail.com)

**Pricop Floarea**

The National Research & Development Institute for Textiles and Leather, Bucuresti, Romania

[pricop44@yahoo.ca](mailto:pricop44@yahoo.ca)

**Iordache Ovidiu**

The National Research & Development Institute for Textiles and Leather, Bucuresti, Romania

[iordacheovidiu.g@gmail.com](mailto:iordacheovidiu.g@gmail.com)

**Petrescu Gabriel**

DFR Systems SRL, Drumul Taberei 46, Bucuresti, Romania

[dfr@dfr.ro](mailto:dfr@dfr.ro)

**Popescu Alina**

The National Research & Development Institute for Textile and Leather, Bucharest, Romania

[certex@ns.certex.ro](mailto:certex@ns.certex.ro)

**Darko Ujević**

Faculty of Textile Technology University of Zagreb, Croatia

[darko.ujevic@tff.hr](mailto:darko.ujevic@tff.hr)

**Dr. Éva Hottó**

Óbuda University  
Faculty of Light Industry and Environmental Engineering

Product Design Institute

[hotto.eva@rkk.uni-obuda.hu](mailto:hotto.eva@rkk.uni-obuda.hu)

**Blaženka Brlobašić Šajatović**

Faculty of Textile Technology University of Zagreb

**Rascov Marian**

The National Research & Development Institute for Textile and Leather, Bucharest, Romania

**Scarlat Razvan**

The National Research & Development Institute for Textile and Leather, Bucharest, Romania

**Cerempei Angela**

Gheorghe Asachi” Technical University of Iasi, Faculty of Textiles, Leather and Industrial Management, Iasi, Romania

**Muresan Emil**

Gheorghe Asachi” Technical University of Iasi, Faculty of Textiles, Leather and Industrial Management, Iasi, Romania

**Moga Corina**

DFR Systems SRL, Drumul Taberei 46, Bucuresti, Romania, [dfr@dfr.ro](mailto:dfr@dfr.ro)

**Slaviša Đurđević**

"Singidunum Sverige", Storgatan 254, Uddevalla, Sweden

**Dragan Čočkaló**

University of Novi Sad, Technical faculty “Mihajlo Pupin”, Zrenjanin, Serbia

**Miloš Vorkapić**

University of Belgrade, ICTM - CMT, Belgrade, Serbia

**Dr. Gabriella Oroszlány**

Óbuda University  
Faculty of Light Industry and Environmental Engineering

Product Design Institute

[hotto.eva@rkk.uni-obuda.hu](mailto:hotto.eva@rkk.uni-obuda.hu)

**Mihalj Bakator**

University of Novi Sad, Technical faculty "Mihajlo Pupin", Zrenjanin, Serbia

**Bin Yu**

Zhejiang Sci-Tech University of China

**Yunchu Yang**

School of Fashion Design & Engineering,  
Zhejiang Sci-Tech University

**Mirjana Ristic**

Mitex Via Fabio Severo 11 34133 Trieste, Italy

**Irma Radovan**

University of Zagreb Faculty of Textile Technology  
irma.radovan@tff.hr

**Nikola Zuvlak**

Dong Hua University Shanghai China

**Boryana Vatova**

New Bulgarian University - "Montevideo" 21,  
1618 g.k. Ovcha kupel 2, Sofia, Bulgaria

**Vojislav Gligorijević**

University of Nis, Faculty of Technology,  
Leskovac, Serbia  
[vojatrick@yahoo.com](mailto:vojatrick@yahoo.com)

**Renata Hrženjak**

University of Zagreb Faculty of Textile Technology  
renata.hrzenjak@tff.hr

**Sandra Stojanović**

The Faculty of Technology, 124 Bulevar oslobođenja  
street, Leskovac

**Dr. Márta Kisfaludy**

Hungary, Óbuda University  
Faculty of Light Industry and Environmental  
Engineering Product Design Institute  
[kisfaludy.marta@rkk.uni-obuda.hu](mailto:kisfaludy.marta@rkk.uni-obuda.hu)

**Mila Kovalic**

University of Novi Sad, Technical faculty "Mihajlo  
Pupin", 23000 Zrenjanin, Đure Đakovića bb,  
Republic of Serbia  
milazakin@gmail.com

**Sanja Stanisavljev**

University of Novi Sad, Technical faculty "Mihajlo  
Pupin", 23000 Zrenjanin, Đure Đakovića bb,  
Republic of Serbia

**Jovan Stepanović**

University of Nis, Faculty of Technology,  
Leskovac, Serbia  
e-mail: [jovan64@yahoo.com](mailto:jovan64@yahoo.com)

**Maja Jankoska**

University "Ss. Cyril and Methodius", Faculty of  
Technology and Metallurgy, Skopje, Macedonia  
Department of Textile Technology  
e-mail: [maja@tmf.ukim.edu.mk](mailto:maja@tmf.ukim.edu.mk)

**Stana Kovačević**

Faculty of Textile Technology, University of Zagreb,  
Croatia

**Ksenija Dolezal**

University of Zagreb Faculty of Textile Technology  
[ksenija.dolezal@tff.hr](mailto:ksenija.dolezal@tff.hr)

**Goran Demboski**

University "Ss. Cyril and Methodius", Faculty of  
Technology and Metallurgy, Skopje, Macedonia  
Department of Textile Technology

**Martina Novak**

Czech Republic

**Nadezda Ljubojev**

University of Novi Sad, Technical faculty "Mihajlo  
Pupin", 23000 Zrenjanin, Đure Đakovića bb, Republic  
of Serbia

**Marija Pesic**

University of Novi Sad,  
Technical Faculty "Mihajlo Pupin" Zrenjanin,  
Serbia  
[marija.stankovic.986@gmail.com](mailto:marija.stankovic.986@gmail.com)

**Dušan Trajković**

University of Nis, Faculty of Technology,  
Leskovac, Serbia  
[dusant@excite.com](mailto:dusant@excite.com)

**Gorna Dembovski**

University "Ss. Cyril and Methodius"  
Skopje, Macedonia,  
[goran@tmf.ukim.edu.mk](mailto:goran@tmf.ukim.edu.mk)

**Danka Joksimović**

Technical Faculty "Mihailo Pupin" Zrenjanin,  
Republic of Serbia  
[danka.jokismovic21@gmail.com](mailto:danka.jokismovic21@gmail.com)

**Volkan KAPLAN**

Pamukkale University, Department of Textile  
Engineering, Denizli, Turkey

**Stanislava Sindelić**

Technical faculty „Mihajlo Pupin“, Serbia  
e-mail: [s.stasa@yahoo.com](mailto:s.stasa@yahoo.com)

**Jovana Stepanović**

Faculty of Technology, Leskovac, Bulevar  
Oslobođenja 124, 16000 Leskovac

**Srdan Cakić**

Faculty of Technology Leskovac, University of Nis

**Milica Marjanovic**

Technical Faculty "Mihailo Pupin" in Zrenjanin,  
Republic of Serbia

**Jelena Djukic**

Technical Faculty "Mihailo Pupin" in Zrenjanin,  
Republic of Serbia

**Sanja Jovic**

Technical Faculty "Mihailo Pupin" in Zrenjanin,  
Republic of Serbia

**Maja Kostic**

Technical Faculty "Mihailo Pupin" in Zrenjanin,  
Republic of Serbia

**Teodora Sesum**

Technical Faculty "Mihailo Pupin" in Zrenjanin,  
Republic of Serbia

**Tatjana Šarac**

The Faculty of Technology, 124 Bulevar oslobođenja  
street, Leskovac

**Nataša Radmanovac**

Faculty of Technology, Leskovac, Bulevar  
Oslobođenja 124, 16000 Leskovac

**Vasilije Petrović.**

University of Novi Sad, Technical Faculty "Mihajlo  
Pupin" Zrenjanin, Serbia  
e-mail: [vlp@eunet.rs](mailto:vlp@eunet.rs)

**Nenad Ćirković**

University of Nis, Faculty of Technology,  
Leskovac, Serbia, e-mail:  
[nenadcira@gmail.com](mailto:nenadcira@gmail.com)

**Mirjana Ristić**

Mitex  
Via Fabio Severo 11  
34133 Trieste, Italy

**Nenad Stojanović**

Yumco Munchen, Germany

**Anita Milosavljević**

Faculty of Technology Leskovac, University of Nis -  
The scholarship holder of the Ministry,  
Republic of Serbia  
[anita.milosavljevic@hotmail.com](mailto:anita.milosavljevic@hotmail.com)

**Nevena Igetic**

Technical Faculty "Mihailo Pupin" in Zrenjanin,  
Republic of Serbia

**Jelena Skenderovic**

Technical Faculty "Mihailo Pupin" in Zrenjanin,  
Republic of Serbia

**Radica Nivic**

University of Nis, Faculty of Technology, Leskovac

**Valentina Bozoki**

Technical Faculty "Mihailo Pupin" in Zrenjanin,  
Republic of Serbia

**Marica Pavlovic**

Technical Faculty "Mihailo Pupin" in Zrenjanin,  
Republic of Serbia